

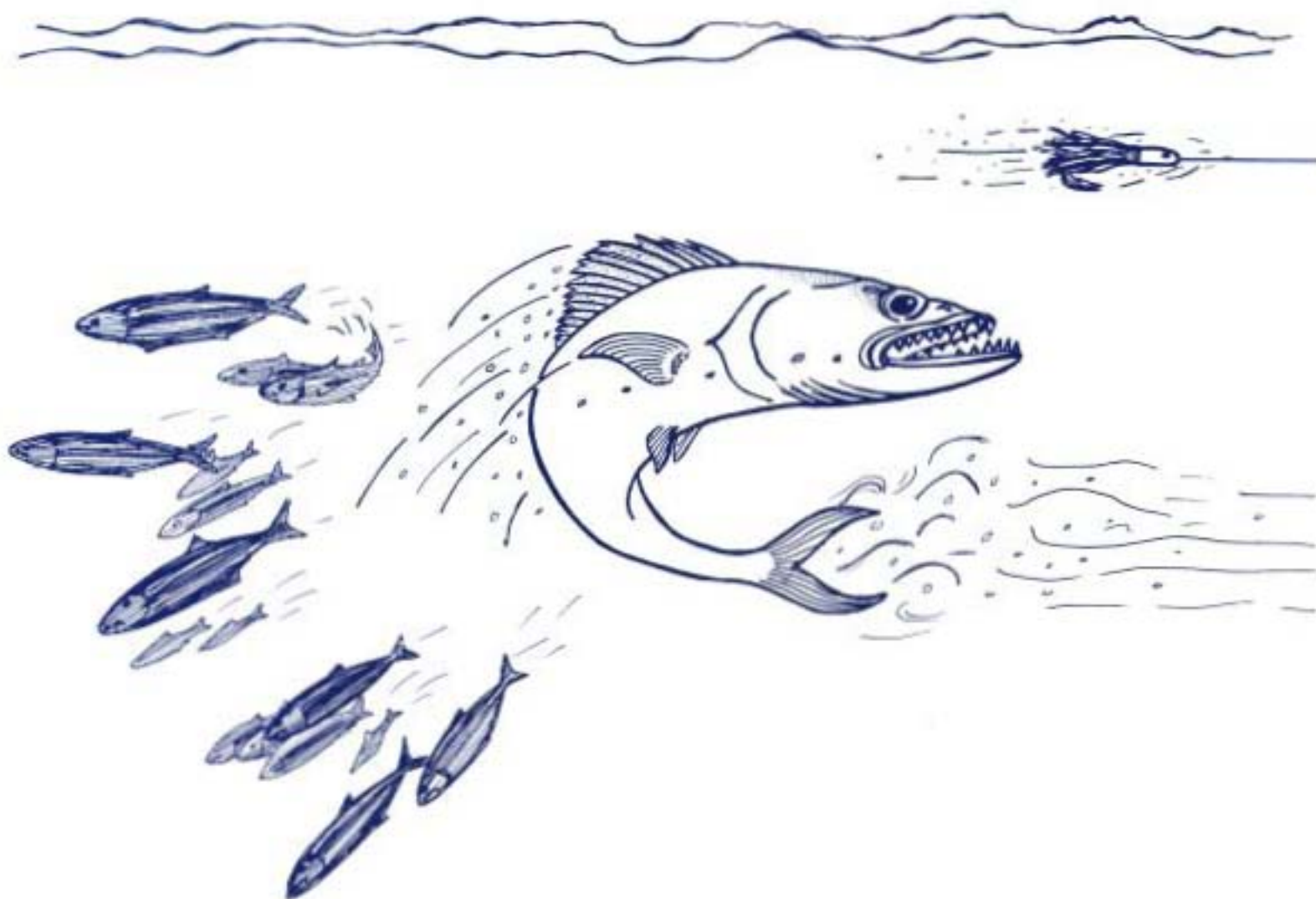

HANDBOOK No. 28 (1987)

TROLLING TECHNIQUES FOR THE PACIFIC ISLANDS

A Manual For Fishermen



SOUTH PACIFIC COMMISSION
NOUMEA, NEW CALEDONIA

TROLLING TECHNIQUES FOR THE
PACIFIC ISLANDS
A Manual For Fishermen

by
G.L. Preston
L.B. Chapman
P.D. Mead
And
P. Taumaia

Illustrated by
S.E. Belew

Produced with the financial support of

The Commonwealth Foundation
The FAO/UNDP South Pacific Regional Fisheries Development Programme
The United States Agency for International Development

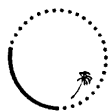

South Pacific Commission
Noumea, New Calefonia
1987

© South Pacific Commission, 1987

All rights reserved. No part of this publication may be reproduced in any form or by any process, whether for sale, profit, material gain, or free distribution without written permission. Inquiries should be directed to the publisher.

Original edition: English

South Pacific Commission Cataloguing-in-publication data

Trolling techniques for the Pacific islands: a manual for fishermen / by G.L. Preston ...[et al] ; illustrated by S.E. Belew.
(Handbook / South Pacific Commission ; no. 28)

1. Trolling (Fishing) -Oceania 2. Fishing -Handbooks, manuals
2. I. Preston, Garry L. II. Belew, Stephen E. III. Series

639 . 2028
ISBN 982-203-120-3

AACR2

Prepared for publication at South Pacific Commission headquarters,
Noumea, New Caledonia, and printed by Stredder Print Limited,
Auckland, New Zealand, 1987

CREDITS AND ACKNOWLEDGEMENTS

The South Pacific Commission has been active in promoting the development of fisheries in Pacific Island countries for over 20 years. During this period, the Commission's work has included the assessment of inshore and offshore marine resources, the introduction and testing of new or exotic fishing gear and techniques, and the provision of training programmes in the technical and vocational skills required to support developing fisheries. A particular area of strength has been the programme of training in fishing and boat-handling techniques for small-scale fishermen and boat owners. This programme, initiated in 1978, has been carried out by the SPC's team of Master Fishermen, who, at the request of Pacific Island governments, visit fishing communities to carry out practical training activities.

This manual has been compiled to answer two needs within the context of SPC's fisheries training activities: firstly, as a means of partially documenting the largely unwritten specialist knowledge and practical experience accumulated by SPC's fishing staff during field activities; and secondly, as a training aid for use by all Pacific Island fisheries extension officers in their endeavours to introduce and explain fishing topics to rural fishermen and others. The information content is organised in a manner which we hope be is well suited to this latter requirement.

Preparing this publication was a collective effort by a team whose areas of responsibility were as follows:

Text, design and editing:	Garry Preston, SPC Assistant Fisheries Officer Lindsay Chapman, SPC Master Fisherman
Technical advice:	Paul Mead, SPC Master Fisherman Pale Taumaia, SPC Master Fisherman Alastair Robertson, SPC Fisheries Training Officer Bernard Smith, SPC Fisheries Adviser
Illustration and layout:	Stephen Belew, consultant graphic artist
Typing and typesetting:	Sylvia Rodgers, SPC Fisheries Training Assistant Kay Legras, SPC Fisheries Training Assistant Cécile Pétron, SPC Typesetting and Layout Artist

Steve Belew's participation in the team was funded by the FAO South Pacific Regional Fisheries Development Programme. Production, material and equipment costs were met by a grant from the Commonwealth Foundation. Printing, publication and distribution of the English edition were funded by the United States Agency for International Development. We are grateful to each of these organisations for their funding support.

CONTENTS

<i>Chapter /Section</i>	<i>Page</i>
INTRODUCTION	1
1. TROLLING BASICS	3
A. Trolling in the Pacific	4
B. Some Trolling Terms	6
2. PREPARING A TROLLING BOAT	9
A. General Vessel Considerations	10
B. Fish Containers	12
C. Ice Boxes	14
D. Trolling Boom Construction	16
E. Trolling Boom Mounting	18
F. Handreels for Trolling	20
G. Handreel Mounting	22
H. Gaffs, Nooses and Nets	24
I. Two Commercial Fishing Arrangements	26
3. PREPARING TROLLING LINES	2
A. Tools and Utensils	30
B. Hooks	32
C. Types of Fishing Line	34
D. End loops in Line and Single-strand Wire	36
E. End Loops in Rope	38
F. End Loops in Cable (Multi-strand Wire)	40
G. Knots for Hooks and Tackle	42
H. Joining Lines Together	44
I. The Assembled Trolling Line	46
J. Sinkers	48
K. Diving Devices	50
L. Rigging Fixed Lines	52
M. Rigging Lines on Handreels	54
N. Rigging Handreels for Trolling	56
4. BAITS AND LURES	59
A. Bait and Lure Types	60
B. Rigging Mackerels and Scads	62
C. Rigging Flying-fish and Small, Round-bodied Fish	64
D. Rigging Garfish and Small, Long-bodied Fish	66
E. Rigging Seapike and Larger, Long-bodied Fish	68
F. Rigging Cut Baits	70
G. Making Octopus Lures	72
H. Rigging Lures	74
I. Lure Maintenance and Storage	76
5. TROLLING TECHNIQUE	79
A. The Variety of Trolling Conditions	80
B. Trolling the Lagoon and Inshore Waters	82
C. Trolling the Outer Reef	84
D. Open Water Trolling	86
E. Trolling Surface Tuna Schools	88
F. Trolling Around Fish Aggregation Devices	90
G. Selecting the Right Baits and Lures	92
H. Selecting the Right Line	94
I. Line Length and Depth	96
J. Trolling Times	98
K. Trolling Speed	100

CONTENTS

<i>Chapter /Section</i>	<i>Page</i>
6. FISHING ACTION	103
A. Before Setting Off	104
B. Working the Lines	106
C. The Strike	108
D. Handling Fish on Fixed Lines	110
E. Handling Fish on Handreels	112
F. Boating the Fish	114
G. Taking Care of the Catch	116
7. COMMONLY CAUGHT FISH	119
A. Fish Habitats	120
B. Surface Schooling Tunas	122
C. Larger Tunas -Bigeye and Yellow fin	124
D. Dogtooth Tuna	126
E. Dolphin Fish	127
F. Wahoo	128
G. Spanish Mackerel	129
H. Barracuda and Seapike	130
I. Trevallies	131
J. Double-lined Mackerel	131
K. Coral Trouts and Groupers	132
L. Sharks	133
M. Others	14
8. AFTER FISHING	135
A. Care of the Boat	137
B. Care of the Fishing Gear	138
C. Care of the Catch	140
D. Keeping Records	141
9. TROUBLE AT SEA	142
A. Injuries	145
B. Accidents	146
C. Breakdowns	148
D. Signalling for Assistance	150
E. Survival at Sea	152
APPENDICES	154
1. Pole-Trolling in the Pacific Tradition	157
2. Further Reading	158

INTRODUCTION

This manual has been written to help Pacific Island fishermen improve their fishing success when trolling, particularly in a commercial or semi-commercial situation. The information it contains has been compiled from the discussions and written records of the South Pacific Commission's fisheries development staff. These officers have a combined experience of over 40 years in fishing and training fishermen in Pacific Island countries.

The manual is intended to act as a guide to the basics of good trolling, for use by interested individual. However, a major aim of the manual is also to be useful in supplementing the formal training activities carried out by the South Pacific Commission and by national fisheries development agencies and extension officers. We have therefore tried to present as much information as possible in a visual form, for the benefit of the many Pacific Islanders whose first language is not English. For the same reason, the text has been kept as simple and non-technical as possible.

In compiling this manual, we have split the many interwoven aspects of trolling into a series of individual topics. Each of these is covered in one double-page spread intended to convey as much information relevant to that topic as possible. We have tried to be comprehensive in the coverage of each subject. Since fishermen tend to be at odds as often as they are in agreement over the details of fishing, we have tried to present the range of options or opinions on subjects where no consensus was clear. Most contentious issues have been avoided unless their mention is considered essential. The topics are organised into chapters which progress through the activities involved in trolling -vessel preparation, gear rigging, the actual fishing procedure, and post-fishing activities. Predictably, it has proven impossible to avoid overlap altogether. However, we hope that the cross-references in the text, together with the detailed topic headings and sub-headings presented in the contents list, will enable readers to follow a given theme through the text, or to find the specific information they seek.



Photo: G.L.Preston *Location: Yadina, Fiji*

A general-purpose fishing vessel suitable for semi-commercial trolling



Photo: G.L.Preston *Location: Vatulele, Fiji*

A catamaran used for tuna trolling around FADs

CHAPTER 1

TROLLING BASICS

A. TROLLING IN THE PACIFIC

B. SOME TROLLING TERMS

CHAPTER 1: TROLLING BASICS

SECTION A: TROLLING IN THE PACIFIC

Trolling is the name given to the type of fishing in which a natural or artificial bait, fitted with hooks, is towed from a line attached to a moving boat. The appearance and motion of the bait is intended to excite carnivorous fish into attacking it, and becoming hooked. This fishing method therefore aims to catch predatory fish, that is the types of fish which chase and eat other fish.

TROLLING CATCHES PREDATORY FISH-EATING FISH

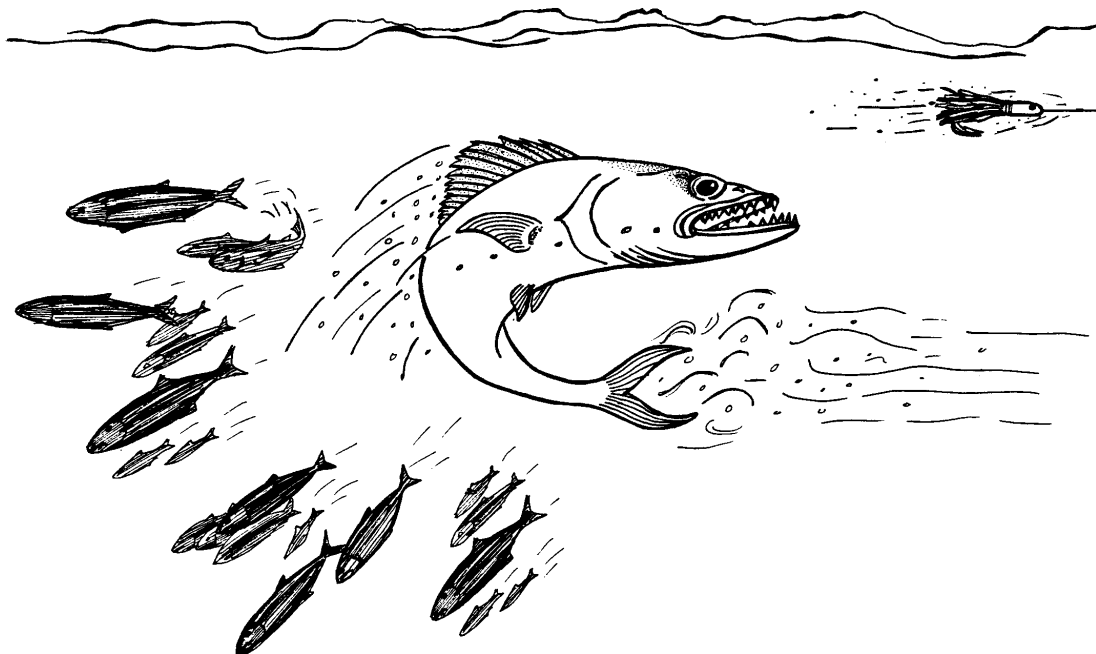

TROLLING IS PRACTISED FROM A WIDE RANGE OF DIFFERENT BOATS

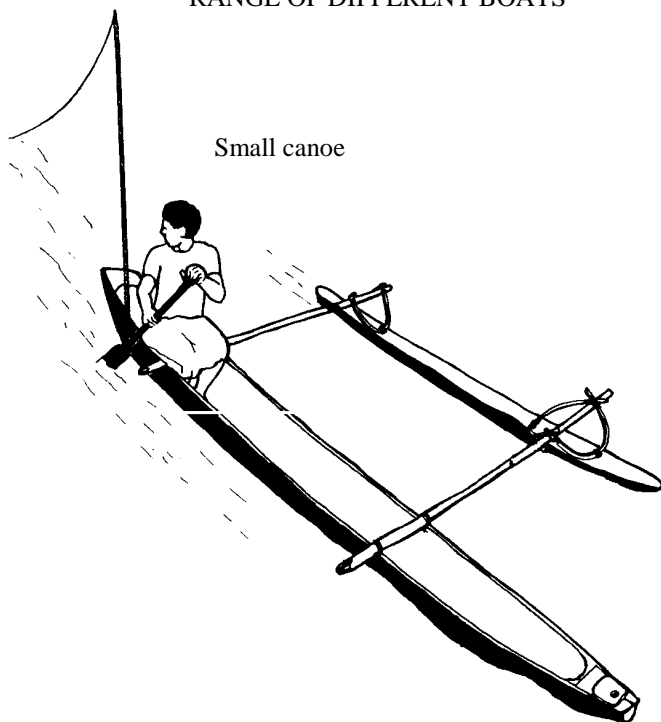

Small canoe

Sophisticated 'gamefisherman'

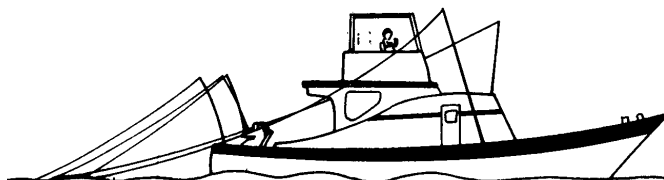

Trolling is a fishing method which is carried out all over the world, for commercial and recreational purposes. There are many variations to the equipment and techniques used. Trolling may be carried out at high speed, so that the fisherman can cover a large fishing area, or slowly, so as to avoid outrunning the fish. The lines may be of light, synthetic material for invisibility, or may be of heavy wire and cable for strength and resistance to cutting. The bait may be towed at the surface, or may be trolled using weights or other equipment to carry it down into deep water. The way in which trolling is performed depends on local conditions, the species sought, and their behaviour and physical characteristics.

CHAPTER 1: TROLLING BASICS

SECTION A: TROLLING IN THE PACIFIC

Trolling should not be confused with trawling, which involves towing nets to catch fish. Trawling for fish is not at present practised in the Pacific Island countries of the SPC region, shown in the map below.

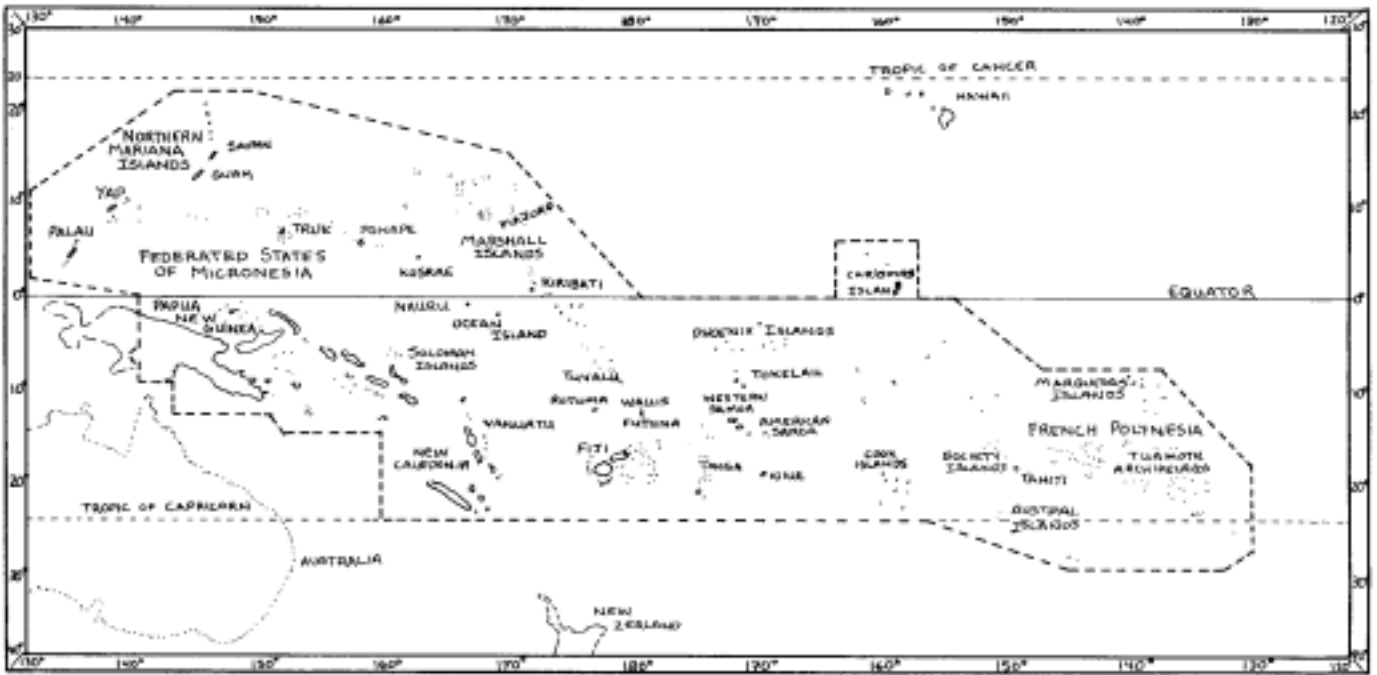

COUNTRIES OF THE SOUTH PACIFIC COMMISSION REGION

In the Pacific Islands, trolling is practised very widely. Most boat owners will troll a line while travelling from one place to another. Many fishermen spend a large part of their fishing time trolling, particularly during certain seasons of the year. In small island countries, some very specialised trolling methods, such as pole-trolling for surface tunas, have evolved for oceanic species. All in all trolling is well known in the Pacific.

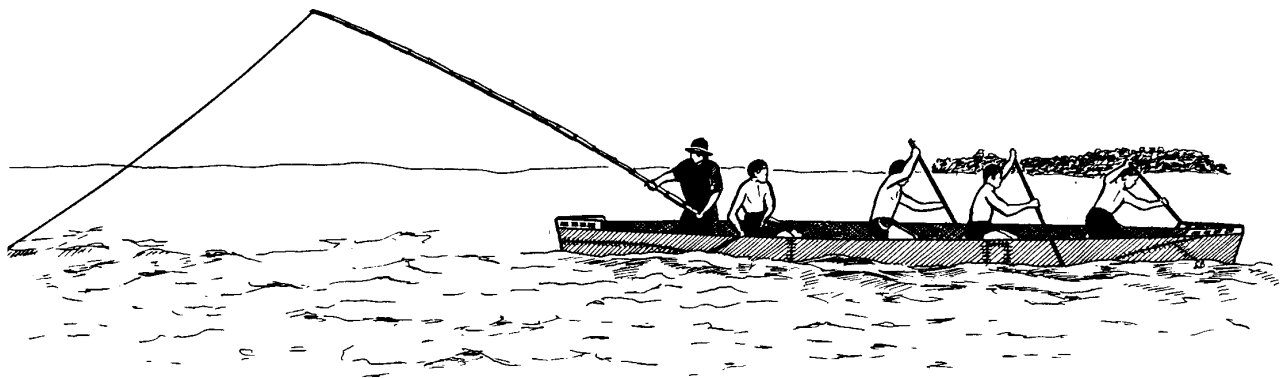

TRADITIONAL POLE-TROLLING FOR TUNAS IN TOKELAU

There are, however, many tricks, tips and simple types of trolling equipment that are still known only to a small proportion of troll fishermen. Some of these are recent innovations; others have been in use for years in certain areas but have never spread further afield. In this book, we have tried to incorporate as many of these fishing tips as possible. We hope that all troll fishermen will be able to find something new here, and use it to improve their fishing operations. Before going into detailed information on trolling, the next section presents some commonly used words and phrases.

CHAPTER 1: TROLLING BASICS

SECTION B: SOME TROLLING TERMS

The following words and phrases are the names of various parts of the boat or fishing line, or items of fishing tackle. They are illustrated in the drawing on the opposite page, and discussed in more detail in the sections noted.

Backing cord (3I)	Figure-8 knot (3D)	Lazy line (3I, 3N)	Snap (3H)
Bait (4A -4E)	Fixed line (3I, 6D)	Lure (4G -4I)	Stay (2E)
Blood knot (3H)	Flemish eye (3F)	Mainline (3I)	Swivel (3H)
Boom (2D, 2E)	Gaff (2G, 6F)	Pulley (2D)	Tag end (3D -3G)
Bowline knot (3E)	Ganged hooks (3B)	Ring (3H)	Tie-wire (3A, 4B -4D)
Cleat	Insulator (2F)	Shock absorber (3I)	Trace (3I)
Clinch knot (3G)	Handreel (2F, 2G, 3M, 3N)	Single hook (3B)	Triple hook (3B)
Diving board (3K)	Haywire twist (3D)	Sinker (3J)	
Double hook (3B)	Ice box (2C)	Sleeve (3A)	
End loop (3D, 3E, 3F)	Killing box (2B)	Slip knot (3G)	

Below are some additional definitions.

Abeam: off to one side of the boat.

Aft: in or towards the stern (back end) of the boat.

Ahead: in front of the boat.

Astern: behind the boat.

Bow: the forward part of the boat.

Cable (also called multi-strand wire): metal lines made of several filaments (wires) twisted together.

Crimping pliers: tool for squeezing shut sleeves (also called crimps).

Downrigger: any device (such as a diving board) that carries the line deeper than it would normally go.

Fore: in or near the bows (front end) of the boat.

Gear shift: the lever or handle that changes the engine drive between forward, neutral and reverse.

Gunwale: the top part of the side of the boat.

Helm: the steering equipment (wheel, tiller or lever) of a boat.

Hold: part of the boat used for storage.

Inboard: on or within the boat.

Kink: a twist in wire or rope that causes it to bend back.

Line: string, cord or rope. Can be of many kinds, including:

monofilament: single filament plastic lines, usually nylon.

multifilament: lines made of several or many threads. The most common are

twine: a fibre line in which two or three bundles of fibres are twisted together.

cord: similar to twine but heavier.

rope: similar to cord but heavier still; usually; has at least three bundles of fibres.

braidle: line of several filaments woven together; often consists of a braided sleeve around a central core of fibres.

Noose: a loop with a running knot, which tightens as the rope is pulled.

Outboard: on the outside of the boat.

Overboard: over the side or outside the boat.

Rudder: an underwater blade attached to the stern of the boat and used for steering.

Standing part: the body of a length of rope or line in which you are tying a knot or making a splice.

Stern: the back part of the boat.

Strike: the action of a fish hitting the lure or bait.

Strop: a short length of rope used to join two objects together.

Tag end: the working end of a length of rope or line in which you are making a knot or a splice.

Target species: the type of fish that you are trying to catch.

Throttle: the mechanism that alters the speed of the engine.

Tiller: lever on the end of the rudder for turning it.

Transom: the top edge of the stern of the boat.

Wire (also called single-strand wire): line made from a single thread or filament of metal, often steel.

CHAPTER 1: TROLLING BASICS
SECTION B: SOME TROLLING TERMS

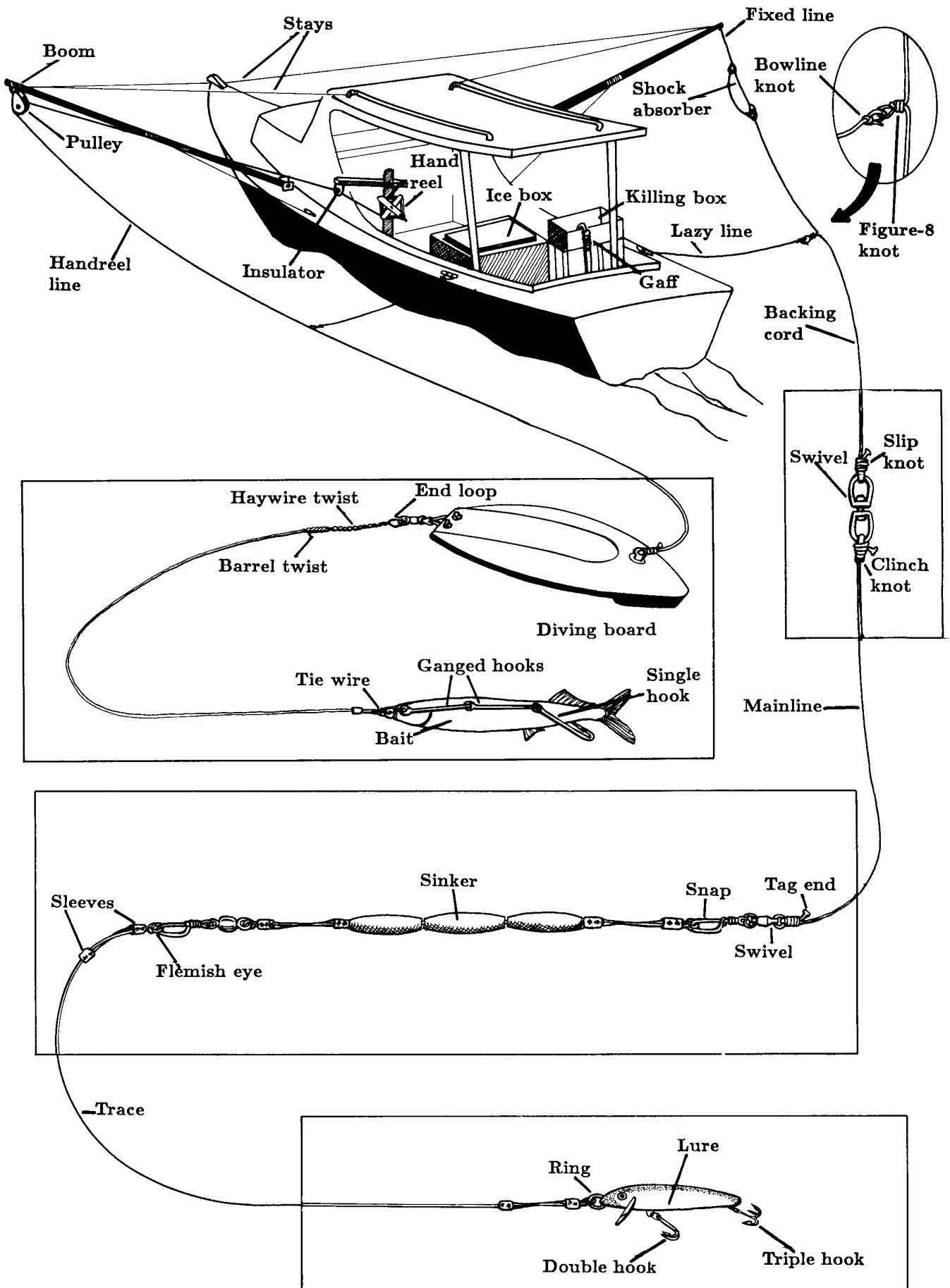



Photo: L. B. Chapman Location: Espiritu Santo, Vanuatu

Fibreglass trolling booms rigged on a small Japanese skiff

CHAPTER 2

PREPARING A TROLLING BOAT

- A. GENERAL VESSEL CONSIDERATIONS -*Fishing positions -Gear storage -Stern gear -Steering -Balance and trim -Deck equipment*
- B. FISH CONTAINERS -*Fish containers -Keeping fish cool- Purpose-built killing box*
- C. ICE BOXES -*Ice containers -Built-in ice boxes -Deck ice box*
- D. TROLLING BOOM CONSTRUCTION -*Materials -Length -Boom tips*
- E. TROLLING BOOM MOUNTING -*Rigid mounting -Vertical joint mounting -Universal joint mounting -Stays -Solid stay*
- F. HANDREELS FOR TROLLING
- G. HAND REEL MOUNTING -*Mounting -Mounting direction -Reinforcing -Comfort -Using cable mainlines*
- H. GAFFS, NOOSES, AND NETS -*Landing nets -Gaffs -Making a good gaff -Safety rope -Gaff points -Shark noose -Fish club*
- I. TWO COMMERCIAL FISHING ARRANGEMENTS -*8.5m (28') 'alia' catamaran -8.5m (28') monohull*

CHAPTER 2: PREPARING A TROLLING BOAT

SECTION A: GENERAL FISHING CONSIDERATIONS

Troll fishing is an active and potentially dangerous occupation. When a fish strikes, a quick response is required from the fisherman to ensure that it is hooked and landed without escaping. On a badly organised vessel, fish will be repeatedly lost because equipment is in the wrong place, because of confusion about whose job is to do what, etc. Some careful thought about the arrangement of the boat will pay dividends in more efficient and comfortable fishing and higher catches.

Fishing positions

If handreels (see sections 2F, 2G, 3M and 3N) are to be mounted on the boat, ensure that they are far enough apart not to interfere with each other, and that the crew using them are not obstructed by deck equipment. Badly positioned or mounted reels can cause severe muscular pain.

Each fisherman should know his spot on the boat, and this is the point from where he should handle his lines, bring aboard fish, etc. Ideally, there should be one crewman for each trolling line, as well as the steersman. For the small boats (under 30', or about 10m) we are talking about in this book, five lines will probably be the maximum number which can be realistically trolled.

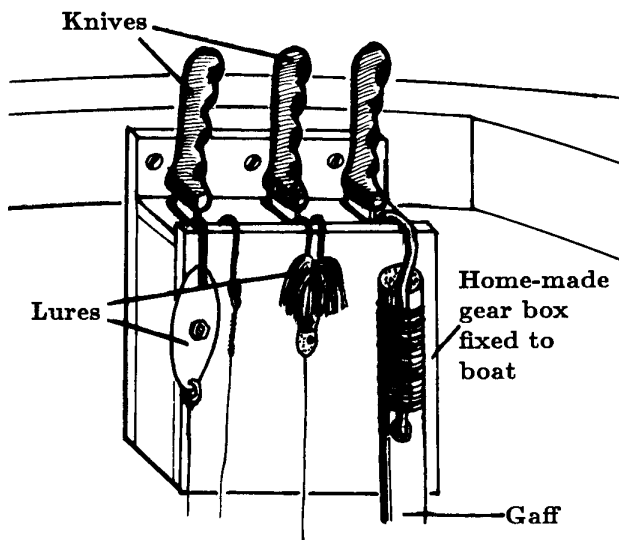

HAZARDOUS GEAR STORED SO IT IS ACCESSIBLE BUT SAFE

Stern gear

On many vessels, the transom or stern seems the natural place to boat fish. However, in some cases the propeller and tiller, or outboard motor, can obstruct easy fishing and may become fouled by the fishing lines. If this is the case, plan to land fish further forward over the side of the boat.

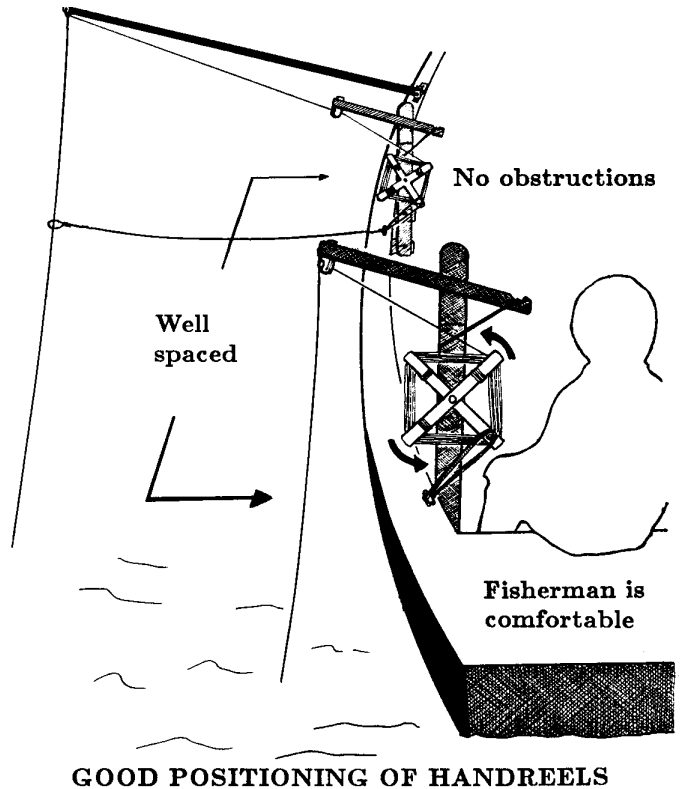

Gear storage

Keep potentially dangerous pieces of often-used deck equipment -such as gaffs, knives, and spare lures -in an accessible but safe place. Store them in a box or choose a particular spot where they should be hung. Never leave them lying around on deck, where they are sure to cause injury.

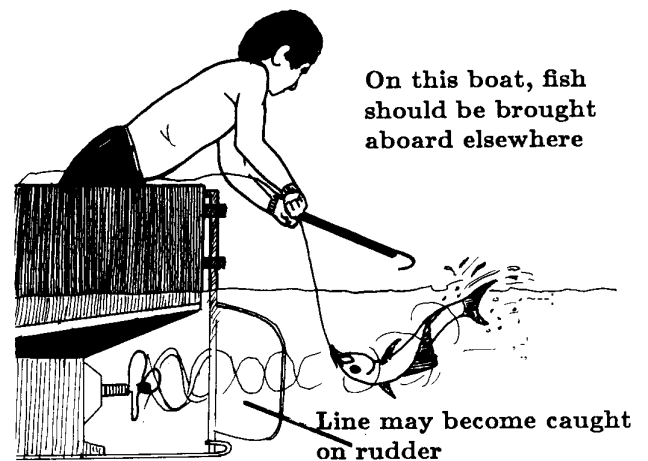

A VESSEL WHOSE RUDDER OBSTRUCTS BOATING FISH OVER THE STERN

CHAPTER 2: PREPARING A TROLLING BOAT

SECTION A: GENERAL VESSEL CONSIDERATIONS

Steering

The steering position, or helm, of the boat is very important. For a boat operating in coral-bound waters or where there is plenty of boat traffic, good visibility is essential and it is usual to have the steering controls well forward. For a fisherman operating alone, however, the steering position is best at the stern, where he can keep a watch on all his lines. Some fishermen install two sets of controls, so that they can steer from either position.

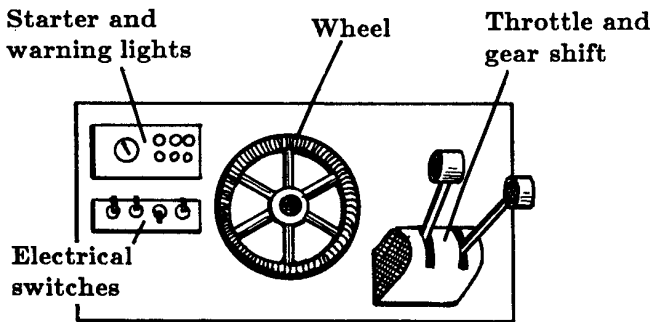
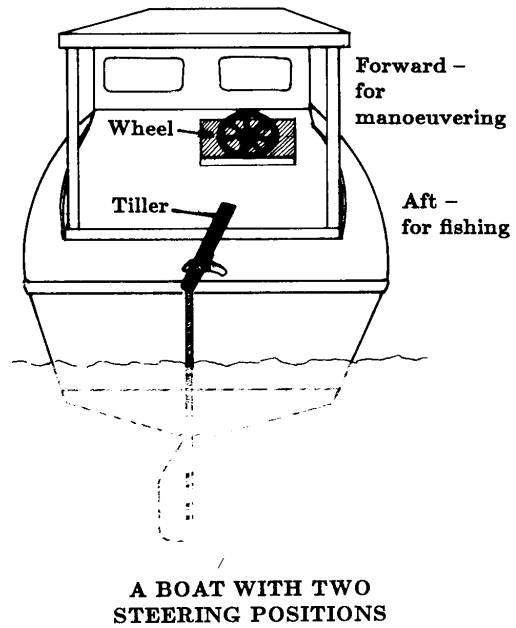

FORWARD HELM SHOULD ALLOW COMPLETE VESSEL CONTROL

Balance and trim

Locate heavy items low down and centrally so that the boat is not unbalanced in any direction. The icebox may be the heaviest item on board when full. Second will probably be the engine(s), and third will be the combined weight of the crew. Try to plan for an even distribution of weight, especially when the boat is underway.

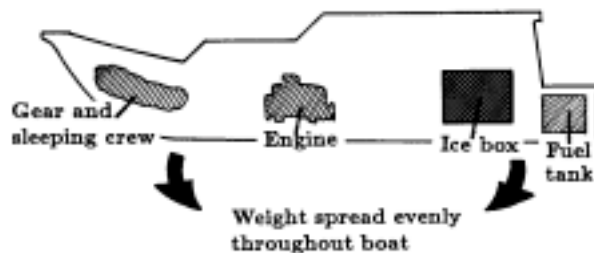
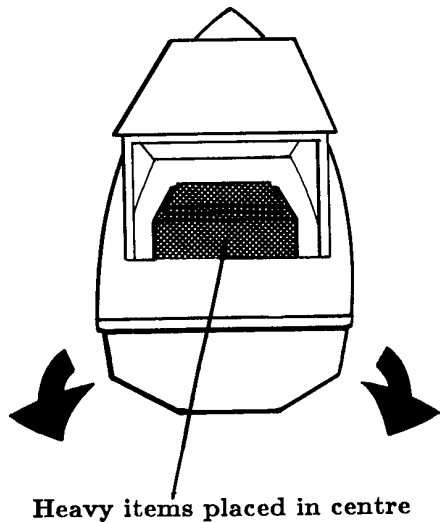

PROPER DISTRIBUTION OF WEIGHT IN THE BOAT

Deck equipment

If you use a killing box or bin (see Section 2B) locate and secure it in an accessible place where all the crew can land their fish into it without difficulty. The ice box (see Section 2C) will be the bulkiest item on board. If possible, locate it so that it does not block off access from one part of the boat to another.

CHAPTER 2: PREPARING A TROLLING BOAT

SECTION B: FISH CONTAINERS

In a small vessel, a troll fisherman often lands his fish directly into the boat. Doing this presents a number of possible dangers and problems. The tail and teeth of a thrashing fish can cause injury, and so can any hooks or wire lines to which the fish is still attached. Slime and blood will make the deck slippery and dangerous. The fish may beat against frames or items of deck equipment, cutting or bruising itself and lowering the quality of the flesh.

Fish containers

Most of these problems can be solved by landing the fish into a box or bin. For small boats, the simplest way is to carry a plastic or wooden fish container big enough to accommodate the size of fish being caught without bending them. If possible, this should be watertight, to allow washing of the fish without blood or slime running on deck.

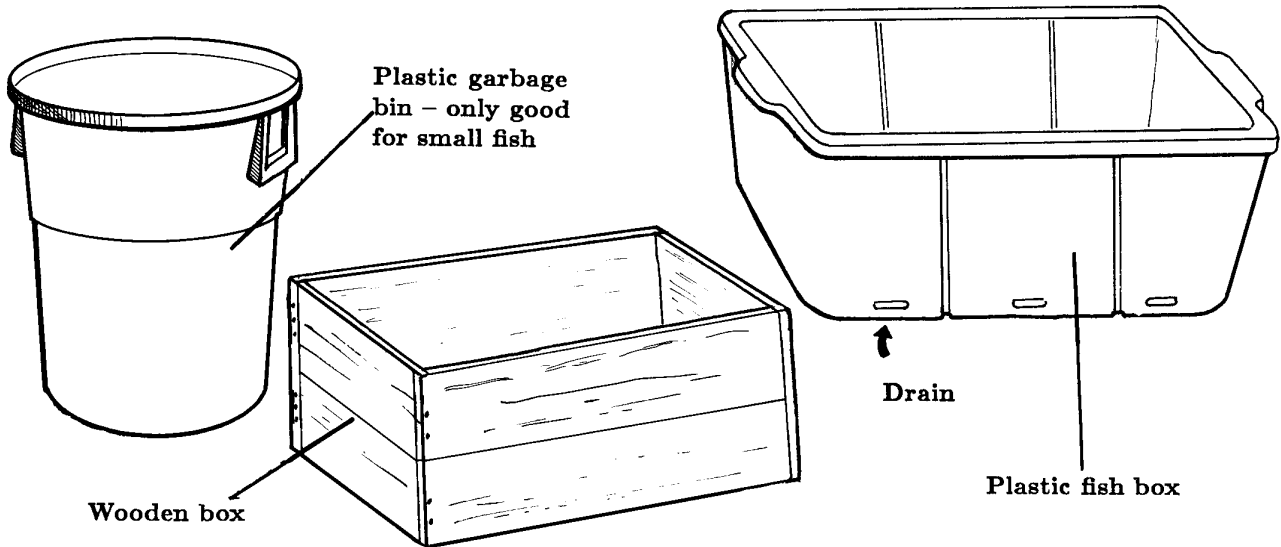

FISH CONTAINERS SUITABLE FOR SMALL BOATS

Keeping fish cool

If the fish will be left in the box for some time, they should be washed to remove blood and slime, then kept shaded and cool to prevent spoilage. The best way to do this is to cover the fish with wet sacking or other cloth. This keeps the fish moist and prevents them drying out, and has a cooling effect as water evaporates from the surface of the sacking.

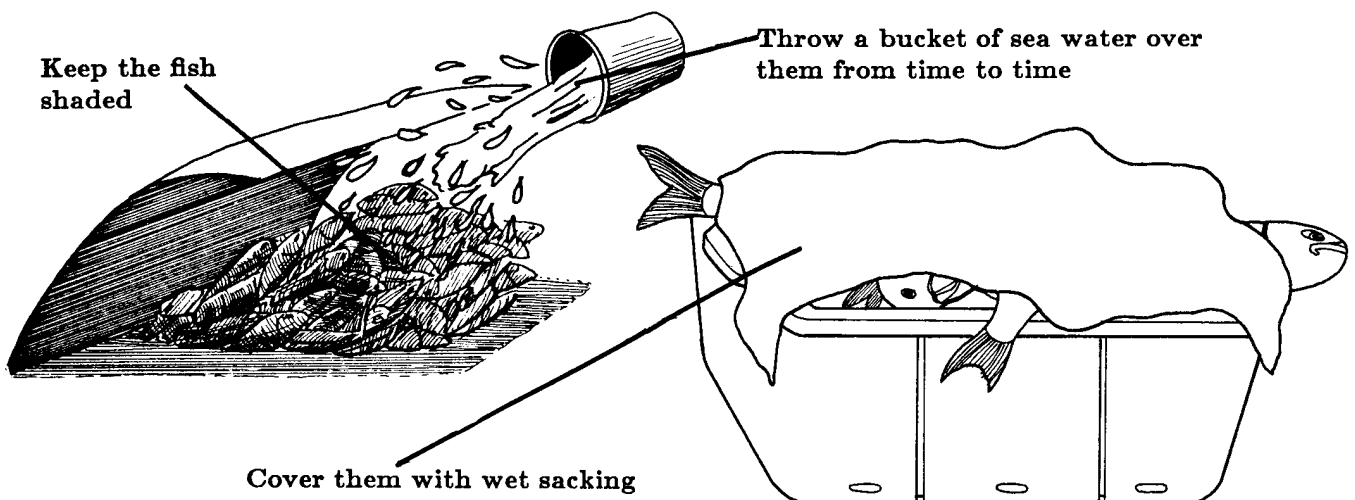

KEEPING FISH COOL WITHOUT ICE

CHAPTER 2: PREPARING A TROLLING BOAT
SECTION B: FISH CONTAINERS

Purpose-built killing box

For larger boats, or for serious full-time fishing, it may be worthwhile to install a purpose-built killing box. This should be:

- big enough to accommodate the size of the largest fish being caught, without bending them and without them jumping out.
- located in a position where fish can be easily lifted straight into it from the water.
- fixed or secured to prevent its moving.
- fitted with a drain pipe which empties through or over the side of the boat.
- built up on legs or in such a way so that the bottom of the box is just above the waterline. The box should not be built higher than absolutely necessary for proper drainage, or it may make the boat unstable. Also, the higher the box, the harder it will be to lift large fish into it.
- fibreglassed or painted to ensure it is watertight and easy to clean.

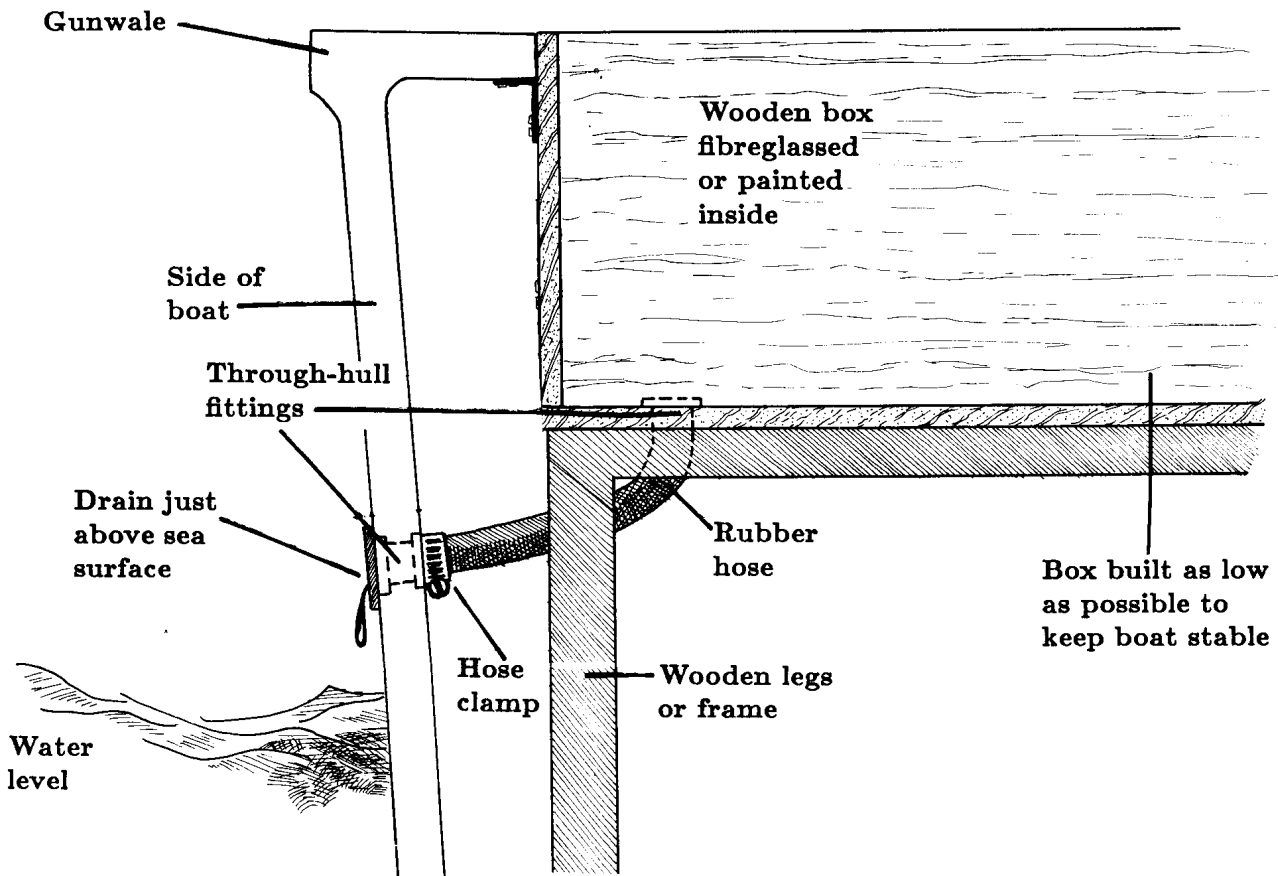
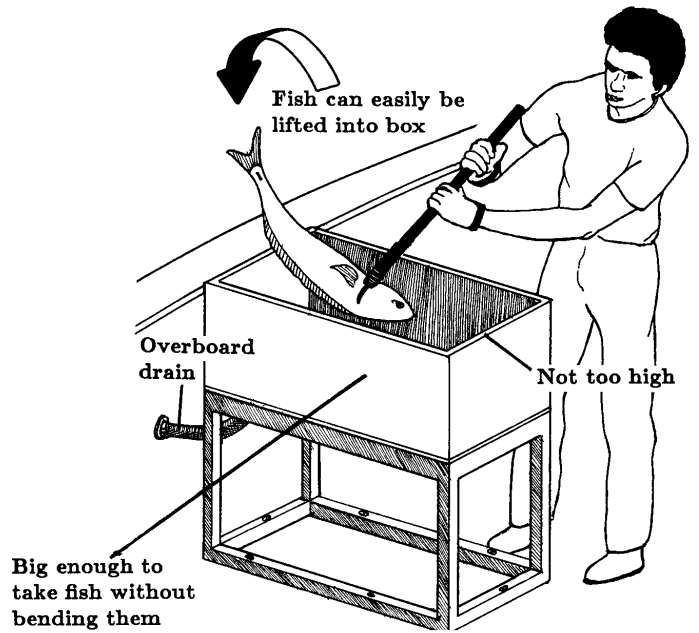

A PURPOSE-BUILT KILLING BOX

CHAPTER 2: PREPARING A TROLLING BOAT

SECTION C: ICE BOXES

Where ice is available, most fishermen will find that its use pays dividends. Ice keeps fish in good condition for longer, so fishermen can stay out at sea fishing for longer periods, and can often get a better price for their fish because it has stayed fresher.

Ice containers

To get the best value out of ice, an on board ice container is needed to stop it melting away. For small vessels, domestic chill bins or "esbies" may be suitable, although expensive. On larger boats, old domestic refrigerators or freezers may be used. These are usually cheap or free, but are not very good, as they are heavy, poorly insulated and rust rapidly, leaving dangerous ragged corners. Insulated 'ice bags' are becoming available in some countries. These are quite expensive, lightly insulated and hard to handle when filled with small fish and ice. However they are useful for the odd very big fish which will not fit into the ice box, and for canoes or other narrow types of boat, due to their shape. (They also make good sleeping mattresses when empty).

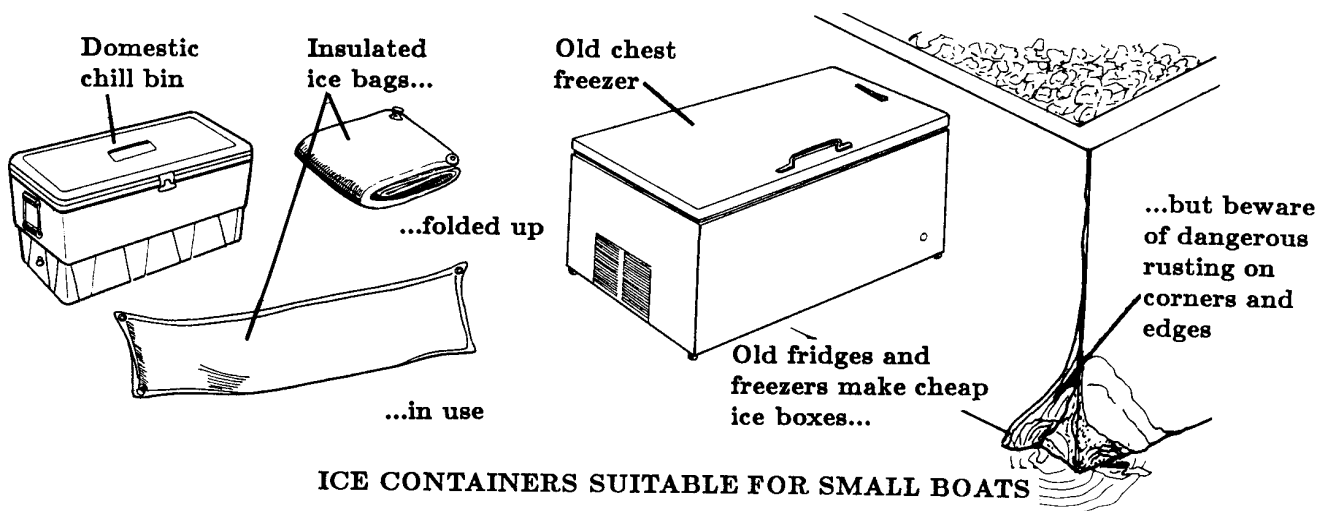

Built-in ice boxes

In some boats, limited deck space or a particular design feature of the hull or working area encourages the builder to construct the ice box as an integral part of the boat's hull. In some boats this works well and results in real savings in space, or in extra convenience for the crew. Built-in ice boxes can double as comfortable seats or bunks, and can convert unused corners or sections of the hull into valuable ice or fish storage space.

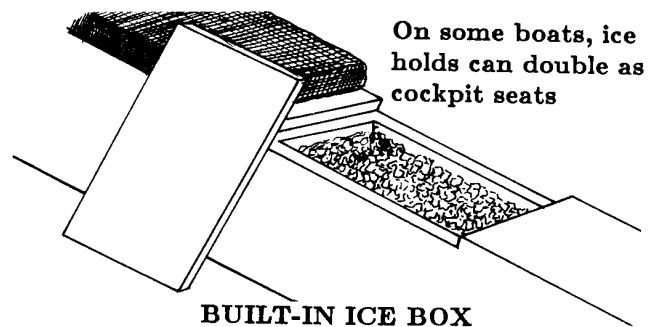

In many cases, however, built-in ice boxes lead to real problems, especially in plywood or wooden boats. The boxes cannot be moved if they turn out to have been badly positioned. Damage to the ice box or water penetration into the insulation may be impossible to repair. *H* the insulation becomes waterlogged it may in turn lead to waterlogging and rot in the hull timbers, or may cause delamination of any external fibre glass sheathing. *H* the hull is holed in the location of the ice box, repair is made more difficult. Proper drainage and cleaning of the icebox may be impossible.

In fibreglass boats, these problems can be kept to a minimum because fibre glass is a waterproof material. Wood, on the other hand, will readily absorb water, and because of this property built-in iceboxes can cause serious problems in wooden boats. *H* a boat owner wants to take advantage of unused hull space, he should consider fitting 'drop-in' ice boxes which can be removed when necessary, or the use of insulated ice bags (see above) as alternatives. Removing a built-in ice box is usually a lot more difficult and time-consuming than building it in the first place.

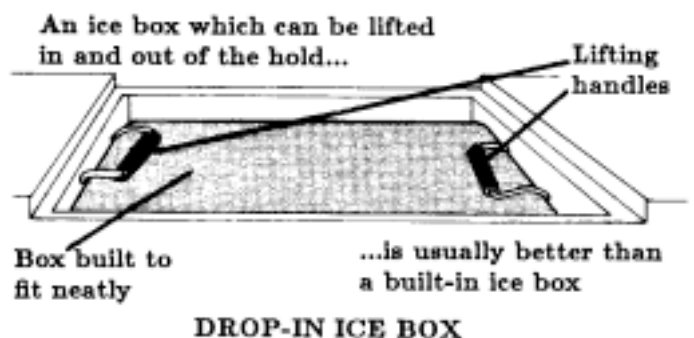

Deck ice box

Where deck space permits, on-deck ice boxes are a better choice, provided they are the proper size and shape and do not interfere with fishing or the boats operation.

These are the important points to keep in mind when buying or building an ice box.

-INSULATION should be at least 5cm (2 inches) thick, and preferably 7.5 to 10cm (3 to 4 inches).

-MATERIAL -the box should be completely waterproof (to keep insulation dry) and smooth for easy cleaning, painted white or a light colour. Fibreglass is the most waterproof and durable material, but many ice boxes are made of plywood, well-painted or coated with waterproof resin. The wood will absorb water if not properly coated.

-LID should be large to give good access and should seal or fit well

-DRAIN should let out meltwater, overboard if possible, into bilge otherwise. Ensure the drain is clear, not blocked by other items of deck equipment, and is big enough not to be blocked by fish scales. To prevent heat entering the ice box, keep the drain plugged most of the time. Unplug it for a few minutes every few hours to release any meltwater which has built up.

In many ice boxes the drain is not properly sealed and allows water to leak around it and into the insulation, which is quickly ruined. If you have doubts about the drain being watertight, seal the edges with a heavy layer of resin or glue. Rather than risk spoiling the insulation, some fishermen prefer ice boxes without drains, even though these will collect meltwater during use and are more difficult to clean out.

-SIZE should not be so big as to obstruct access on boat. When empty two or three people should be able to lift it off the boat. If it is too deep, the fish stored at the bottom of the box will be crushed by those at the top. Choose two smaller ice boxes in preference to one very big one.

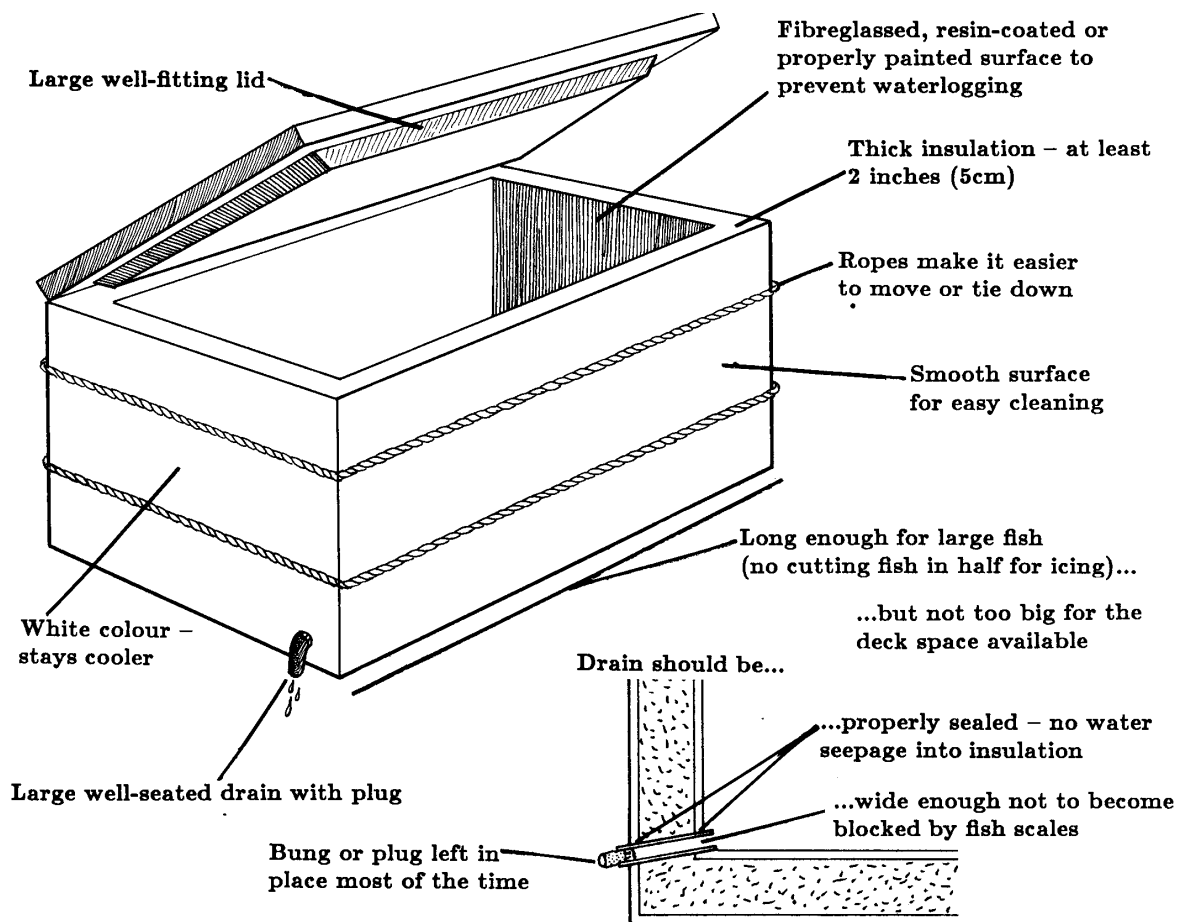

FEATURES OF A GOOD ICE BOX

CHAPTER 2: PREPARING A TROLLING BOAT

SECTION D: TROLLING BOOM CONSTRUCTION

The function of a trolling boom is to allow the lines to be spread further apart, away from each other and from the boat. This reduces the chances of the lines becoming tangled, allows more lines to be used, and increases the area of water covered by the trolling gear.

This section gives details of trolling boom construction, while section 2E covers trolling boom mounting and staying.

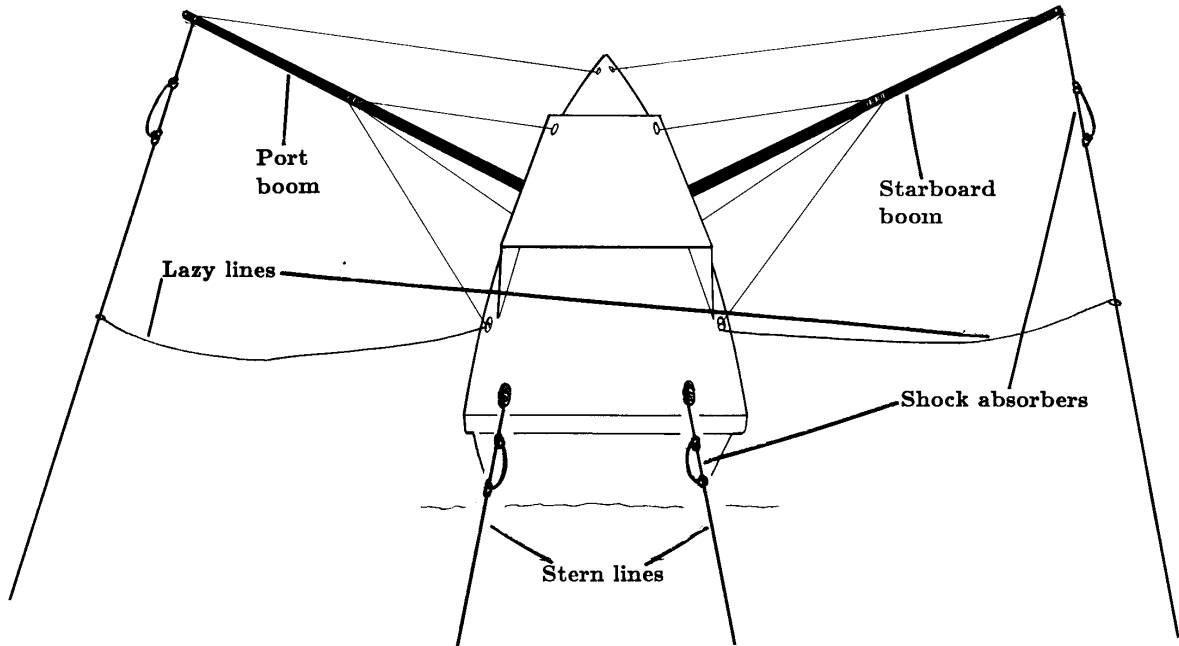

A BOAT RIGGED WITH TWO TROLLING BOOMS

Materials

Materials suitable for trolling booms include sawn or unsawn timber, laminated wooden strips, metal piping and tubular fibreglass or other plastics. The best materials are those which are strong, moderately flexible, lightweight, corrosion resistant, and cheap.

Bamboo

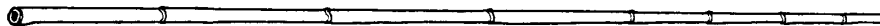

Sawn timber



Fibreglass pole



Straight sapling

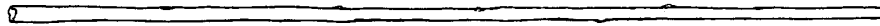

Laminated plywood



Metal piping

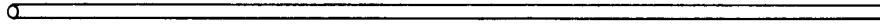

Dimensions

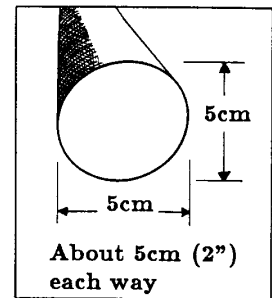

SUITABLE TROLLING BOOM MATERIALS

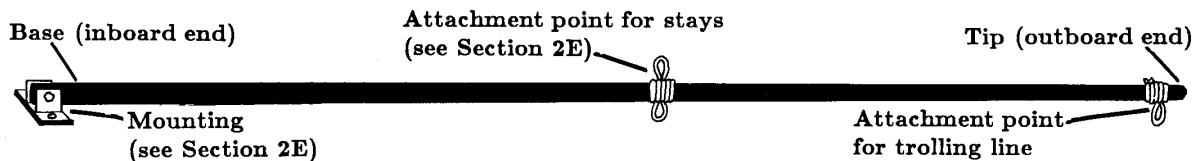

PARTS OF THE TROLLING BOOM

Length

The length of the booms depends on the strength and weight of the material being used, the effectiveness of the staying system (see Section 2E), the size of the boat, the number of lines to be trolled, and the way in which the booms will be stored. With good and careful staying it is possible to use a boom the same length as the boat. However, as a general rule, the boom should be about half the length of the boat and not more than two-thirds. If several lines are to be attached to a boom, they should be at least 1.5 m (5 feet) apart.

Boom tips

The type of fitting needed on the tip of the boom depends on whether it will be used with a fixed line (see Section 3L) or a handreel (see Section 3N).

For fixed lines an attachment point is needed, onto which the line can be tied or clipped. This can be a rope eye, shackle, or similar fitting. Alternatively, if a hole is drilled through the boom, a piece of rope can be run through and secured by a stopper knot. This rope can then act both as the forestay (see Section 2E) and the backing cord (see Section 3L).

When using handreels, the boom must have an eye through which the line can run freely when being reeled in and out. This should be smooth and non-abrasive to prevent chafing of the line. Porcelain electrical-type spike isolators, glass rings, large diameter stainless steel shackles, etc. are adequate.

None of these end fittings are suitable if the handreel has a wire or cable mainline, as they will cause it to curl. For wire or cable, a pulley, preferably nylon or plastic, and ideally at least 8cm (3 inches) in diameter should be used.

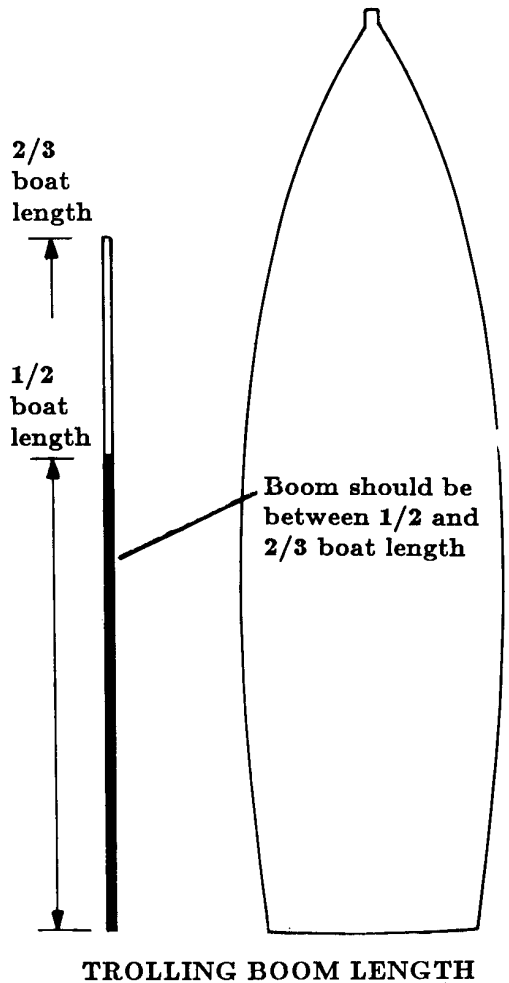

SUITABLE TROLLING BOOM TIPS

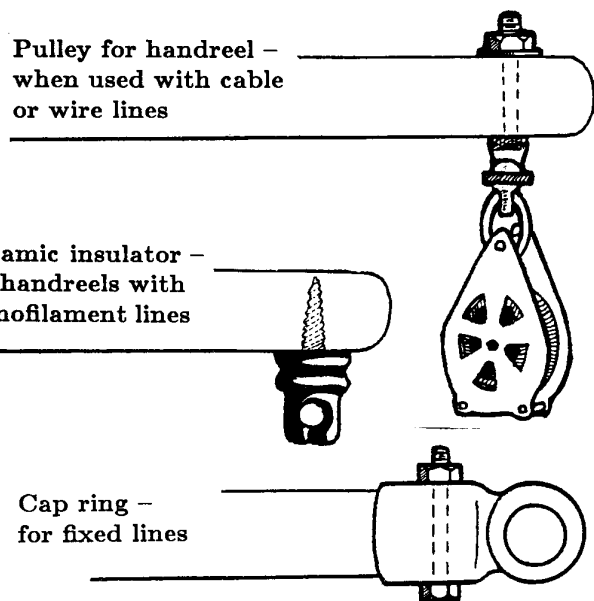
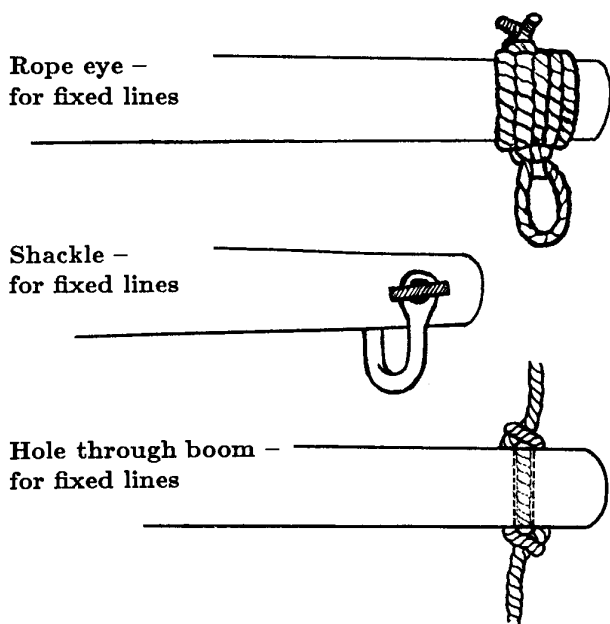

CHAPTER 2: PREPARING A TROLLING BOAT

SECTION E: TROLLING BOOM MOUNTING

Booms are generally mounted fairly well forward on the boat by fixing down the inboard end in one of a number of ways.

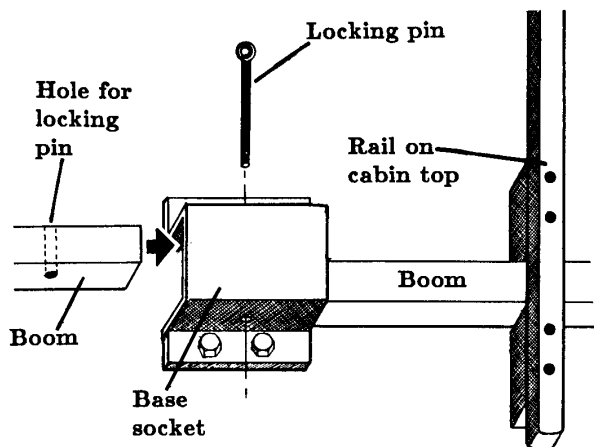

Rigid Mounting

The booms are slotted into sockets on the boat and may be fixed in place with a pin to prevent them falling out. This type of mounting is simple to make but the booms may dip in the water as the vessel rolls, and must usually be taken down for storage.

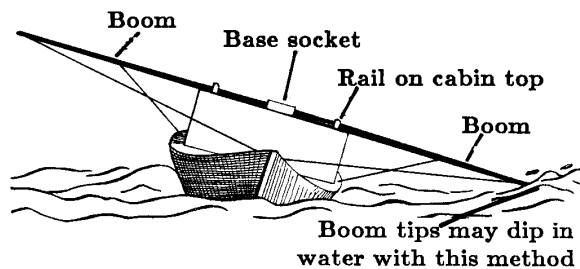

RIGID MOUNTING

Vertical joint mounting

The boom bases are fitted into a hinged socket or mounted on a pin in a way which enables them to swing vertically. This system allows adjustment of the boom angle to prevent dipping in rough seas, and the booms can be stored vertically when not in use, without the need to disconnect them.

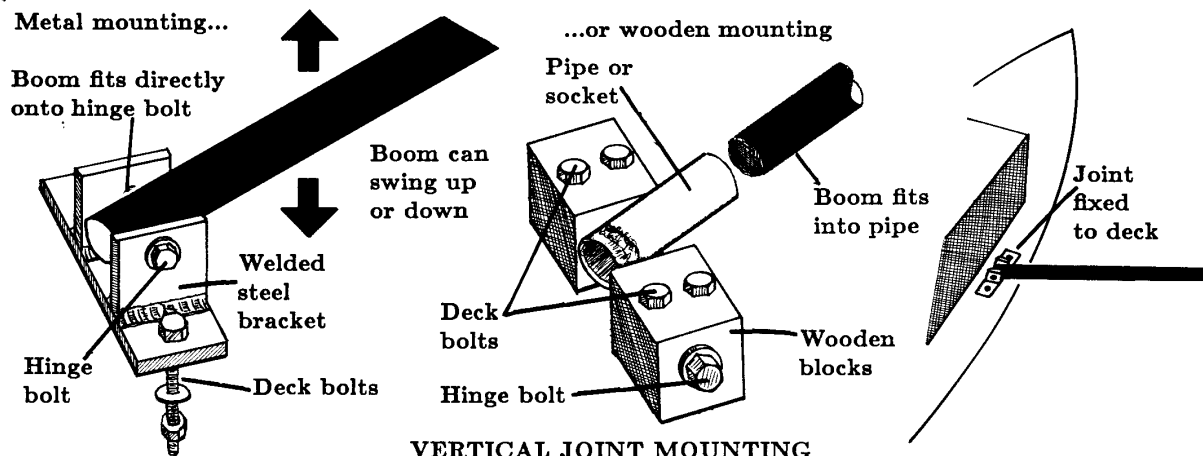

VERTICAL JOINT MOUNTING

Universal joint mounting

The boom bases are attached to a simple universal joint which allows movement both vertically and horizontally. The booms can be laid flat or tied upright for storage without the need to disconnect them.

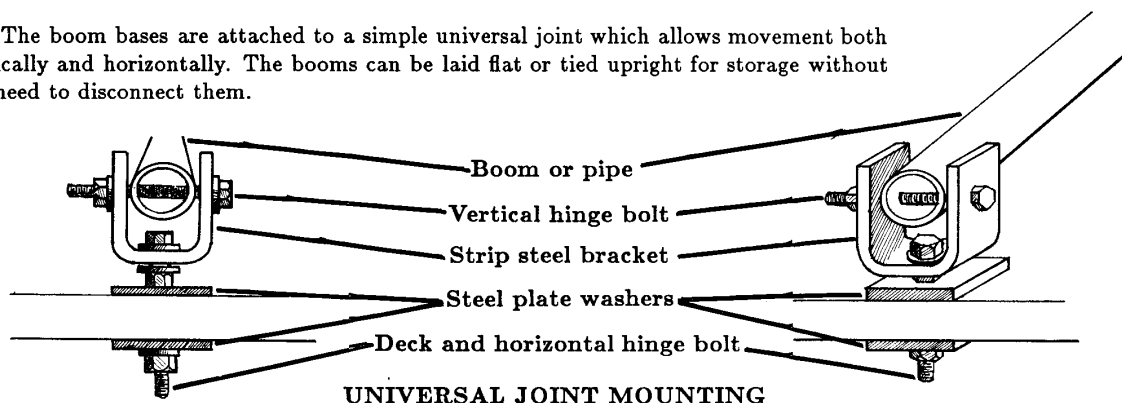

UNIVERSAL JOINT MOUNTING

CHAPTER 2: PREPARING A TROLLING BOAT

SECTION E: TROLLING BOOM MOUNTING

Stays

Stays are very important load-bearing ropes or cables which prevent the booms from swinging about, bending or breaking. They should be attached to the boom by tying, lashing or clipping on. A fully stayed boom has one or more forestays, a backstay, a top stay and a bottom stay.

FORE STAY- this is the most important as it takes the load when a fish strikes or the boom tip dips into the sea during a roll. Without a forestay, the boom will bend and may break under heavy load.

All trolling booms require forestays. There should be one for every trolling line attached to the boom. The forestays should be fixed to the boom close to or at the attachment points of the lines.

TOP STAY (also called the GUY) -this takes the weight of the boom itself, and permits the boom angle to be adjusted to prevent dipping into the water in rough seas. If the boom is being used with a handreel, the topstay ends up taking more and more of the weight as the fish is reeled in. A top stay is recommended for rigidly mounted booms and is essential for other types. It should be attached as far out along the boom as leverage will allow.

On some boats, there may not be a fixed point high enough to anchor the topstays to. A solution is to tie each end of a length of rope to the topstay attachment points on each of the booms, then tighten it up by jamming a 30-60cm (1-2 feet) wooden spreader hard underneath it. This method is most suitable for rigidly mounted booms, but can be used anywhere provided that the other stays give a firm resistance for the spreader to work against.

BACK STAY -this prevents the boom whipping forward, particularly after a strike. It also prevents the boom from bowing too much in the middle when a heavy load (such as the weight of a striking fish) is placed on the end.

A backstay is needed for booms mounted on universal joints and is recommended for other types of mounting. It should be attached about halfway along the boom.

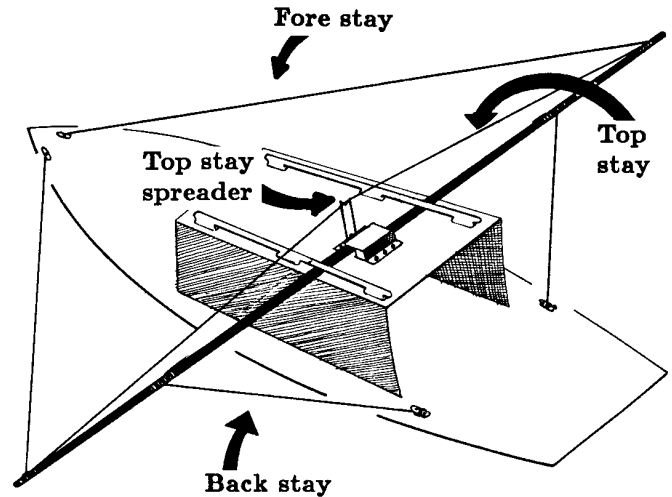

FULLY STAYED RIGIDLY MOUNTED BOOMS

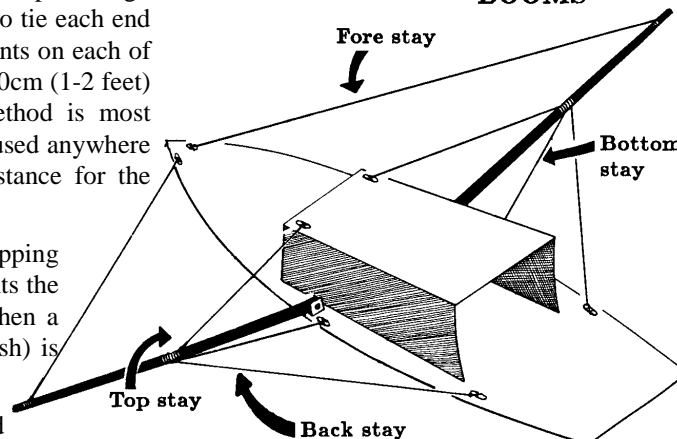

FULLY STAYED FLEXIBLY MOUNTED BOOMS

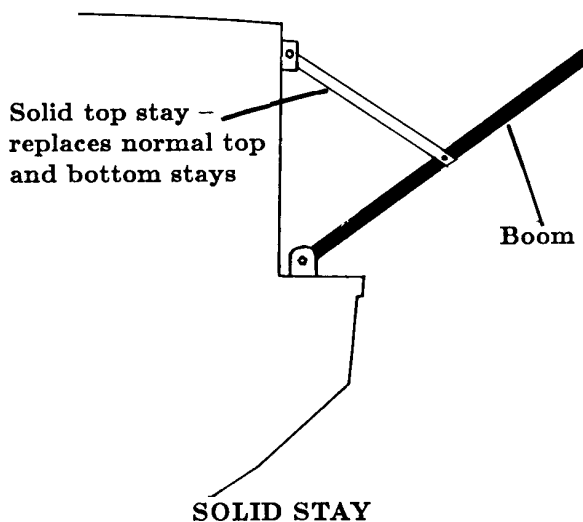

BOTTOM STAY -this prevents the boom bouncing up when the vessel rolls or a fish strikes. A bottom stay is not necessary for rigidly mounted booms but is essential for other types.

Solid stay

If the boom is mounted low and a bottom stay cannot be attached, a solid stay made of wood, steel pipe, etc. can be fixed between the boom and a point on the boat to serve the same purpose. Because it works in both directions, a single solid stay acts as both topstay and bottom stay.

CHAPTER 2: PREPARING A TROLLING BOAT

SECTION F: HANDREELS FOR TROLLING

Many commercial or semi-commercial troll fishermen find handreels to be an efficient trolling tool. They reduce the chance of line tangles and increase the speed at which fish can be recovered and the line returned to the water. However, to be fully effective handreels must be strongly constructed, properly adjusted, and arranged efficiently on the boat.

Many varieties of fishing reel are available commercially, and several are suitable for trolling. These are usually fitted with friction brakes and an easily adjusted mounting system, and most are robust and constructed from materials which will last for a long time even in the marine environment. However, they are usually expensive (typically US\$300-600) and of limited availability in the Pacific region.

More widely used is the wooden cross-reel shown below. This was first introduced into Western Samoa in 1975 by FAO, and has since been promoted by the SPC Deep Sea Fisheries Development Project. Many Pacific Island Fisheries Departments are now making these reels from locally available materials, and they can also be constructed by private individuals.

Although quite simple in appearance, a lot of care must be taken when constructing this reel if it is to work properly. A badly made reel will cause much frustration and reduce the effectiveness of fishing operations, and may break at the most important moment - that is, with a large fish on the line. For these reasons, the SPC has produced a separate handbook which gives detailed instructions and plans to enable proper construction of the FAO Samoan reel. This is called *SPC Handbook No 25: Notes on the construction of the FAO wooden handreel* and is available from the South Pacific Commission (address in front of this handbook).

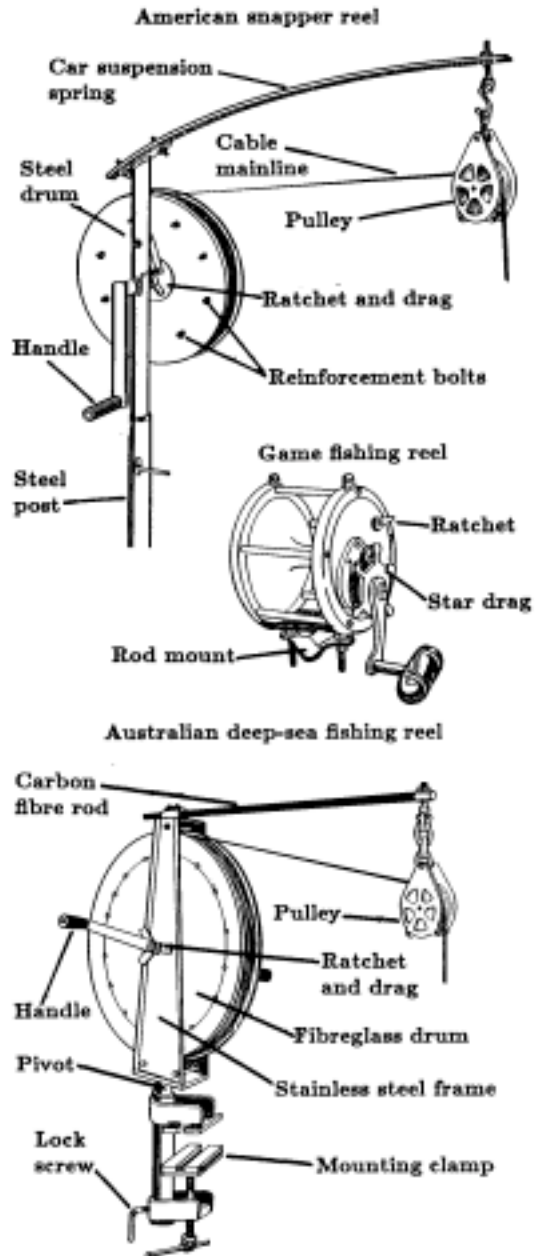
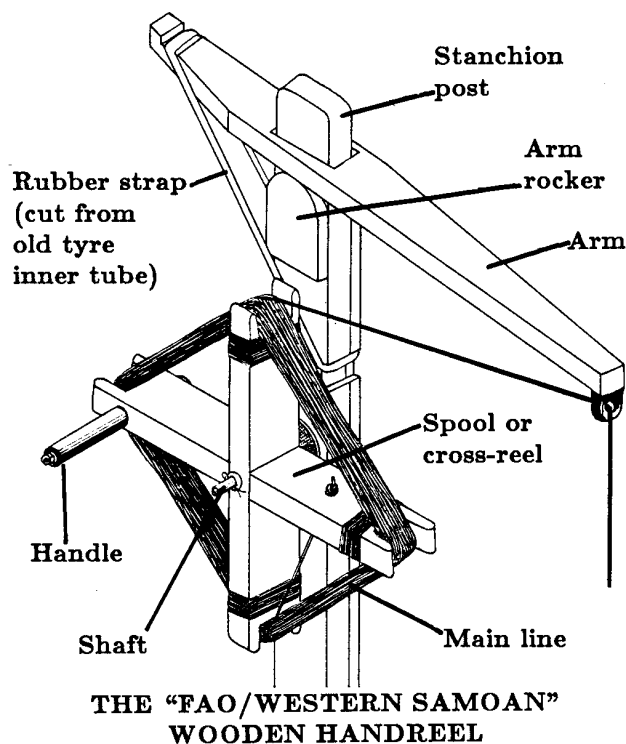

SOME COMMERCIALY MADE REELS

The most common fault in making these handreels is poor alignment of the line, which causes it to 'miss' the reel when being wound in. To ensure good alignment it is very important that the holes for the reel shaft and the lever arm are cut straight and accurately. Only limited adjustment is possible by adjusting the insulator position or adding more spacing washers to the reel shaft.

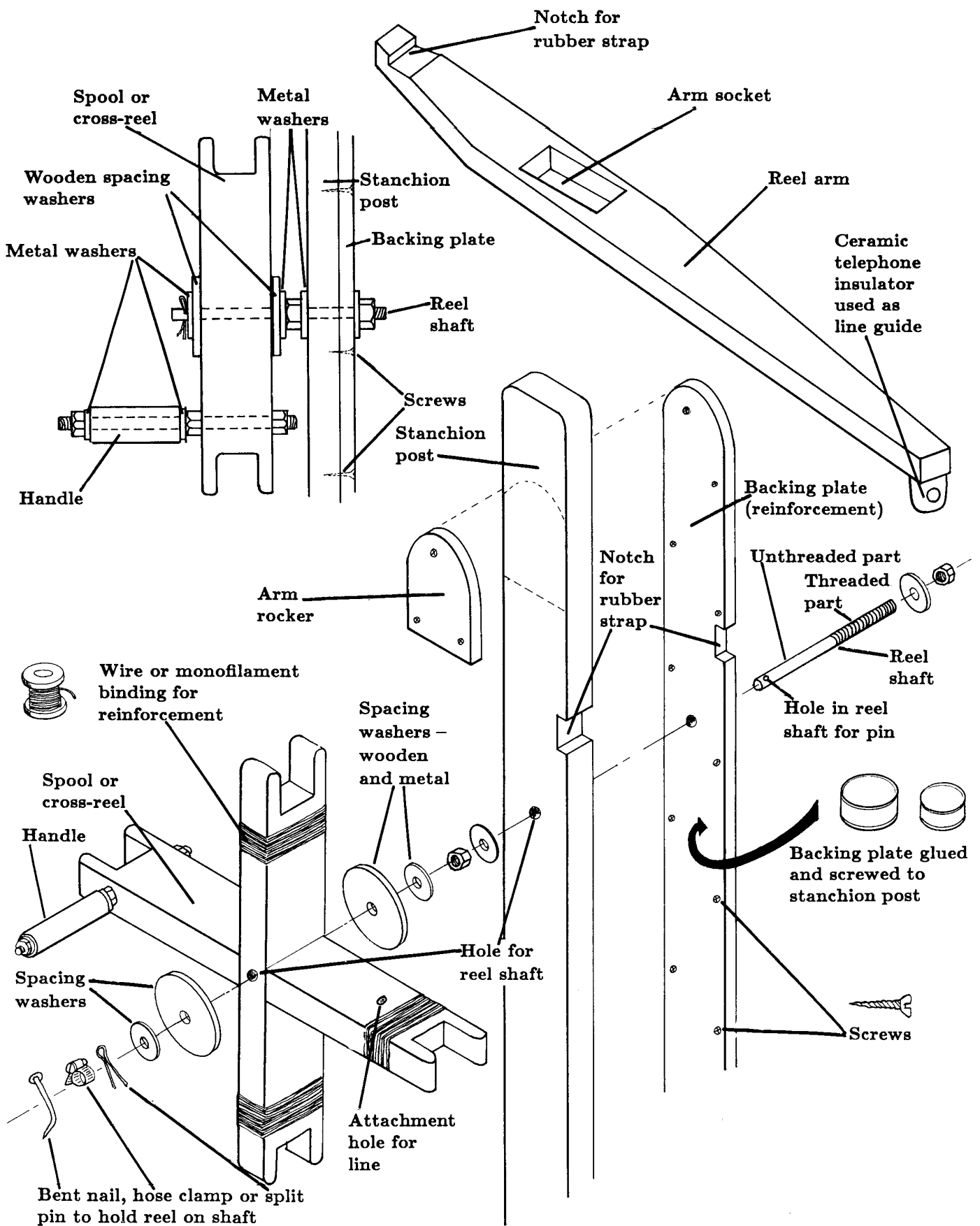

PARTS OF THE WOODEN HANDREEL

CHAPTER 2: PREPARING A TROLLING BOAT

SECTION G: HAND REEL MOUNTING

This section concerns mounting the FAO/ Samoan wooden handreels discussed in Section 2F.

Mounting

Wooden reels are usually mounted by drilling holes through the stanchion posts and bolting them to the frames of the vessel, or to other suitable points. The posts should be bolted in at least two places, to ensure they are secure and will not move under load. Alternatively the posts can be lashed down, although this is less suitable.

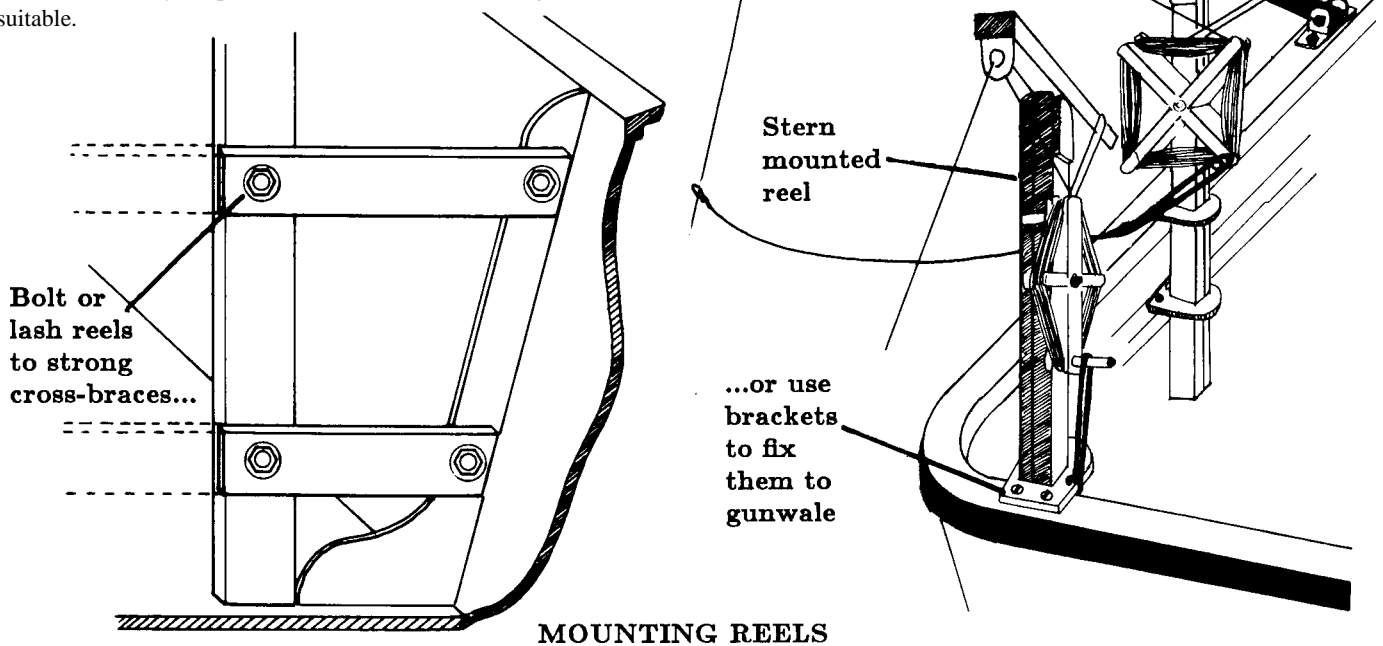

Mounting direction

Reels can be 'side-mounted', that is with the reel-arm sticking out over the side of the boat, or 'stern-mounted', in which case the reel-arm points toward the stern or transom. Reels which are used for trolling through a boom should be side-mounted. Reels used for trolling without a boom can be stern-mounted. These mounting arrangements prevent the reels being subjected to too much twisting force when a fish strikes. However, the ideal arrangement may not be possible because of restricted deck space, or because a different arrangement may be needed to enable the boat's use for other types of fishing.

For those fishermen who need to regularly change the mounting position of a reel, or dismantle it completely from the boat, it may be preferable to mount it using square wooden or steel brackets screwed to appropriate points on the frames or other parts of the boat. To do this, it is also necessary to increase the thickness of the stanchion post at the point where it fits in the bracket, by screwing on pieces of timber to make the post square in cross-section. The post can then easily be inserted into the brackets, where it will stay firm in either the side-mounted or stern-mounted position.

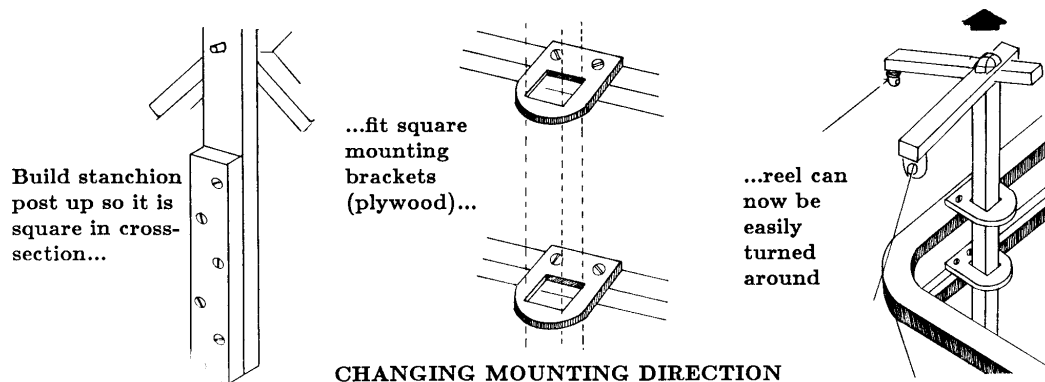

Reinforcing

When a reel is side-mounted and used for trolling directly (that is, not rigged through a trolling boom), the force of a striking fish tends to twist the reel. This can pull the insulator out of line with the reel, making it awkward to wind in the fish. With big fish, the stanchion post may split or break.

Reels mounted in this way should therefore be reinforced by adding a backing plate. This replaces one of the two small lever arm rockers normally fitted (see Section 2F). In fact, it is a good idea to reinforce all reels in this way, regardless of their intended use.

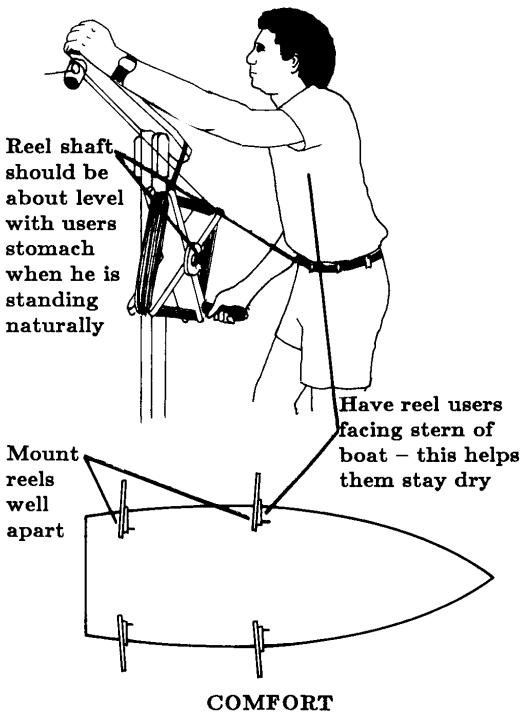

The reels should be mounted as far apart as possible, in places where they are accessible and free from obstruction, and where they themselves will not obstruct other aspects of the fishing operation.

Using cable mainlines

If using cable or wire for the main line, the electrical type spike isolator normally used as a line guide on this type of reel is not suitable. Wire pulled under tension through an insulator will curl and rapidly become unusable, or may break. In this case it is important to replace the isolator with a free-running pulley, preferably of a large diameter (up to 15 cm, or 5-6 inches). This should be attached to the reel lever so that it is aligned with the direction of pull of the line. Those pulleys which come fitted onto a swivel are the best type.

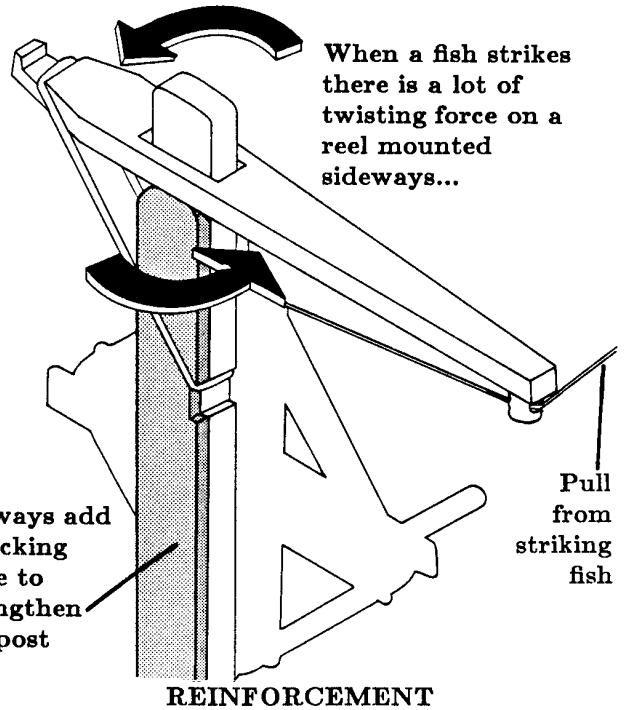

Comfort

When mounting the reels, remember the fisherman's comfort. Badly placed reels can cause severe muscular strain to the user. Mount the reel so that the shaft is about level with the user's stomach, and the post follows the midline of the body when the user is standing comfortably in front of it.

If possible, position the reels so that the users face the stern of the boat. This will avoid them being drenched with drops of water from the line every time they wind it in. The wind usually blows from ahead or abeam of a moving boat and will carry any water spray away from the user of a reel facing backwards.

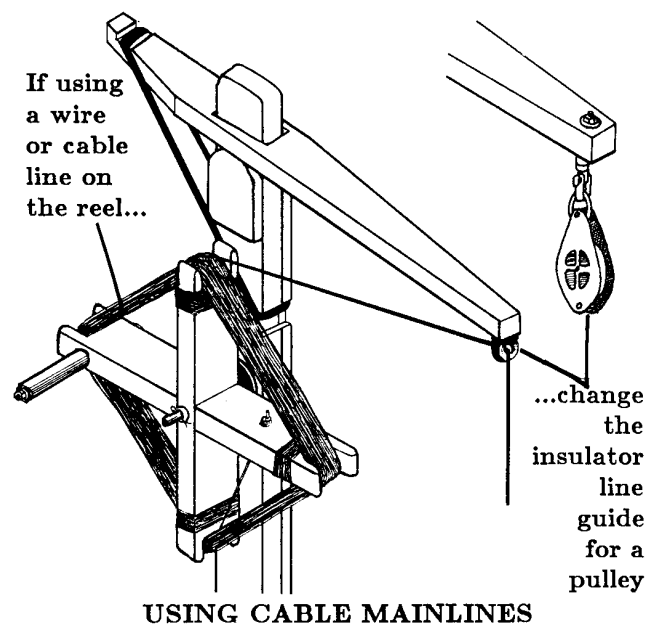

CHAPTER 2: PREPARING A TROLLING BOAT

SECTION H: GAFFS, NOOSES AND NETS

The time when a troll-caught fish is most likely to break loose or become unhooked is the moment when it is being hauled from the water into the boat. Gaffs and other fish landing tools are used to reduce this risk.

Landing nets

Landing nets are most suited to small fish (5 kg (about 11 lb) and under). Netting small fish is much more sensible than gaffing them, and causes less physical damage.

A landing net can be bought, or made by tying a piece of netting onto a stiff frame of wire, metal rod or piping. The netting should be knotless if possible and of small mesh size to avoid tangling the fish. A triangular frame is the easiest to construct and use. The frame should be lashed onto a strong handle. Handle length is normally between 0.5 and 2.5m (about 2-8 feet), depending on the height of the boat above the water.

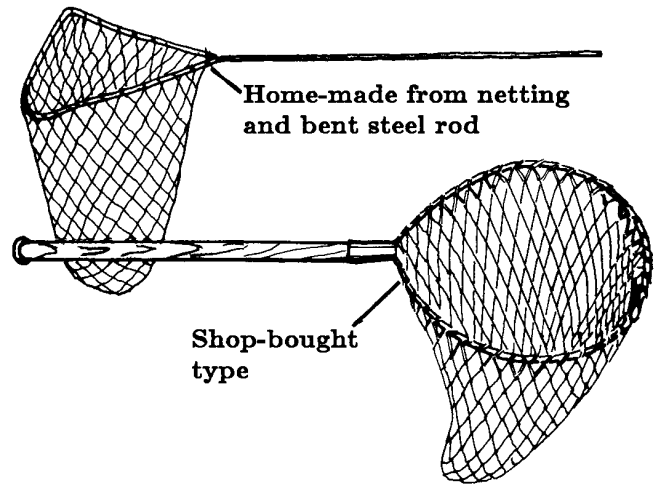

LANDING NETS

Gaffs

Gaffs are used for bigger fish, over about 5kg (10-11lb). They require more skill on the part of the user, and result in damage to the fish, particularly if badly handled. They can also be dangerous.

The two main types are the 'L-gaff' and the 'J-gaff', which have different shapes. Their actions are shown in section 6F. A small gaff with a wide-open bite is good for smaller-sized fish. A larger gaff with a narrower bite is more common and is better for larger, heavy fish.

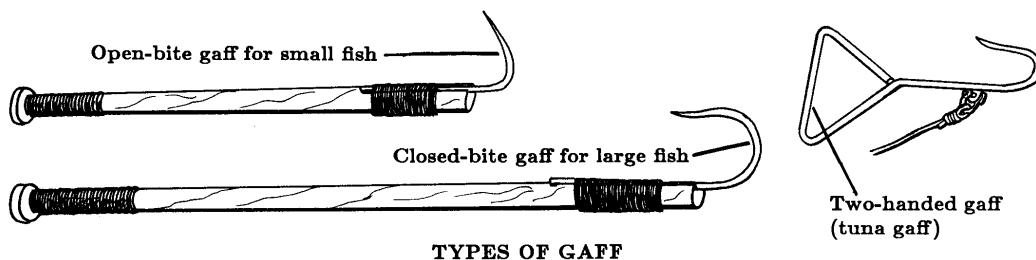

TYPES OF GAFF

For very heavy fish which have been played to exhaustion, a double-handed gaff (also called a tuna gaff) enables the fisherman to put all his strength into heaving it aboard. These are specialised gaffs not found on most general trolling boats.

Making a good gaff

The gaff head is usually bought ready made but can be home-made if necessary by bending and filing a stainless steel or other metal bar. On many commercially made heads, the bite is too small, and needs to be bent further open for normal commercial use. Make sure the base of the head shaft is turned over at right angles to prevent twisting.

The handle is usually wooden, and should be grooved to accommodate the head shaft. Attachment is by tight binding, preferably using wire, which will not be cut by the sharp teeth of fish. The other end of the handle should be wrapped or wound with cord to ensure a good grip.

The length of the gaff handle depends on the normal distance between fish and fisherman at the time of gaffing. A long handle can be very dangerous if the fisherman loses his grip on it when gaffing a thrashing fish. In general, handles should be kept as short as is reasonably possible. Many boats carry both a long-handled and a short-handled gaff.

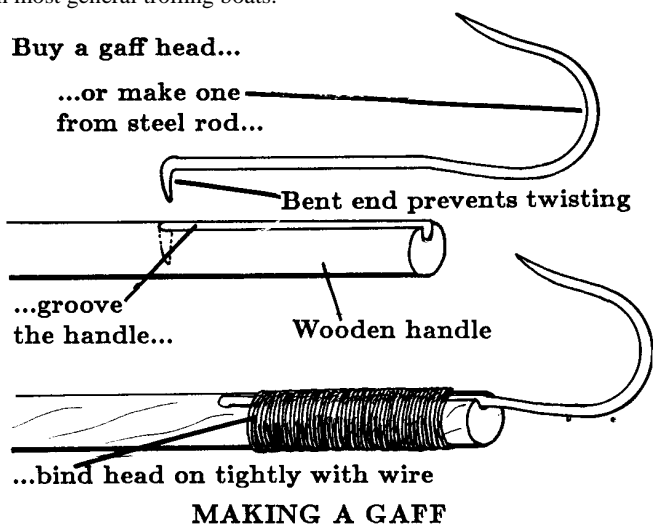

MAKING A GAFF

Safety rope

When gaffing large or violently fighting fish, it is useful to attach a safety rope which will prevent the fish escaping if the fisherman loses his grip on the gaff handles. The rope should be attached to the head end of the gaff, half-hitched along the handle, and tied off at the end. This will enable the fisherman to regain control of the gaff handle if he loses his grip on it while gaffing a thrashing fish, and will prevent the loss of the fish and the gaff head if the handle breaks. The other end of the rope should be tied to the boat.

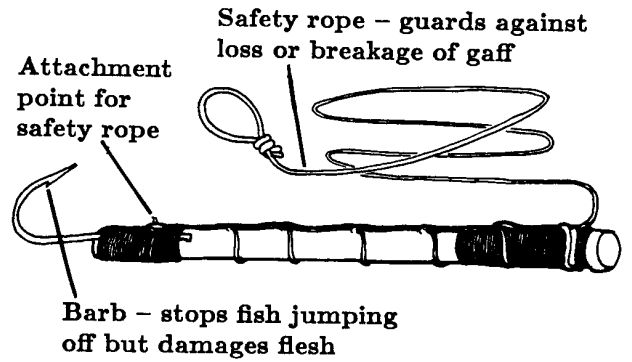

SAFETY ROPE AND BARB

Gaff points

Most gaffs are barbless in order to prevent too much damage to the fish flesh. However, this increases the chances of the fish leaping off the gaff. Filing a barb into the point will greatly reduce the number of fish which come off the gaff, and should be considered if this is a problem.

The point of the gaff should be sharpened regularly. See the instructions for sharpening hooks in Section 3B.

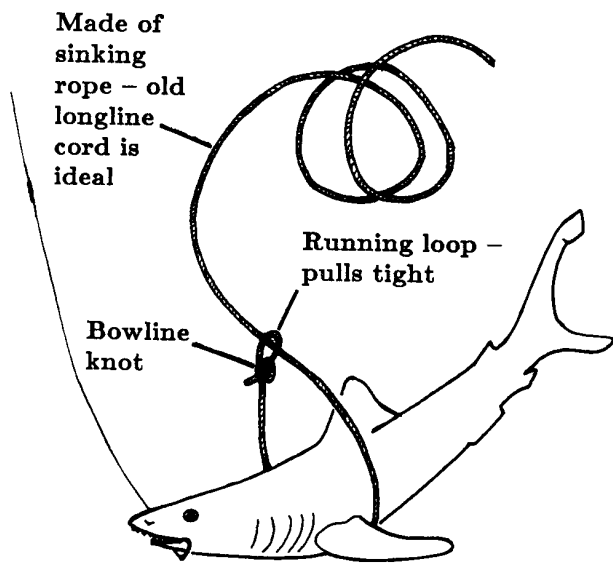

SHARK NOOSE

Shark noose

This is a simple length of strong rope which should preferably sink, and be hard-laid. Ordinary 6 mm (1/4inch) diameter Kuralon longline cord is ideal.

The rope is usually passed around the fishing line on which the shark is hooked, made into a noose by use of a bowline or similar knot, then manoeuvred around the shark's body and pulled tight.

Fish club

This is used to subdue violently active fish once they are in the boat. A good club is about 50 cm (18 inches) long, and 5 cm (2 inches) in diameter at the business end, made of heavy wood and having a handle lashed with cord to ensure a good grip. An old chair leg will often be found suitable.

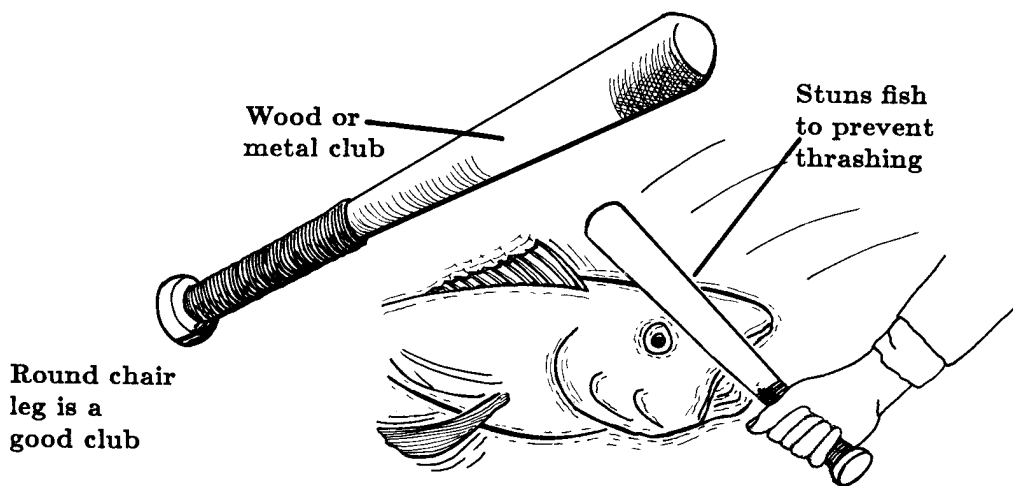

FISH CLUB

CHAPTER 2: PREPARING A TROLLING BOAT

SECTION I: TWO COMMERCIAL FISHING ARRANGEMENTS

The most important points to think about in preparing a boat for commercial or semi-commercial trolling have been discussed in the preceding sections. This section shows examples of how these principles can be applied in rigging up two types of vessel, both in common use in the region -the 8.5 metre (28-foot) outboard-powered 'alia' catamaran, and the 8.5 metre (28-foot) inboard diesel-powered V-bottom monohull, both designed and promoted by FAO.

The 'alia' is shown fitted with handreels and rigid-mounted trolling booms, the 'V-bottom' with fixed lines and flexibly mounted booms. There is no reason why these should not be the other way round, or why other types of vessel could not be modified to incorporate the useful features shown.

8.5m (28') 'alia' catamaran

The 'alia' was designed specifically for the Western Samoan skipjack trolling fishery, in which local fishermen generally make two trolling trips a day -one in the morning and one in the evening -to one of several offshore fish aggregation devices (FADs).

To chase the skipjack schools, the 'alia' is designed to be light and fast. Its main disadvantage is that it is unable to carry much weight without losing a lot of its speed. In particular, it is not feasible to carry a large, heavy ice box with a full load of ice and fish on an 'alia'.

Due to its open nature, limited accommodation and fuel-hungry outboard propulsion, this is a short-trip vessel (1 to 2 days maximum).

Earlier models were made of plywood but modern versions are mainly aluminium. The aluminium versions have proved to be lighter and faster (the original plywood boats were prone to waterlogging, which added a lot to their weight, reduced their speed and increased their fuel consumption) as well as being less work to maintain. Many of the load-carrying problems of the wooden version are much reduced in the aluminium 'alia'.

Because of the use of handreels, a crew of at least 2, preferably 4, is required on a boat rigged up as shown in the drawing.

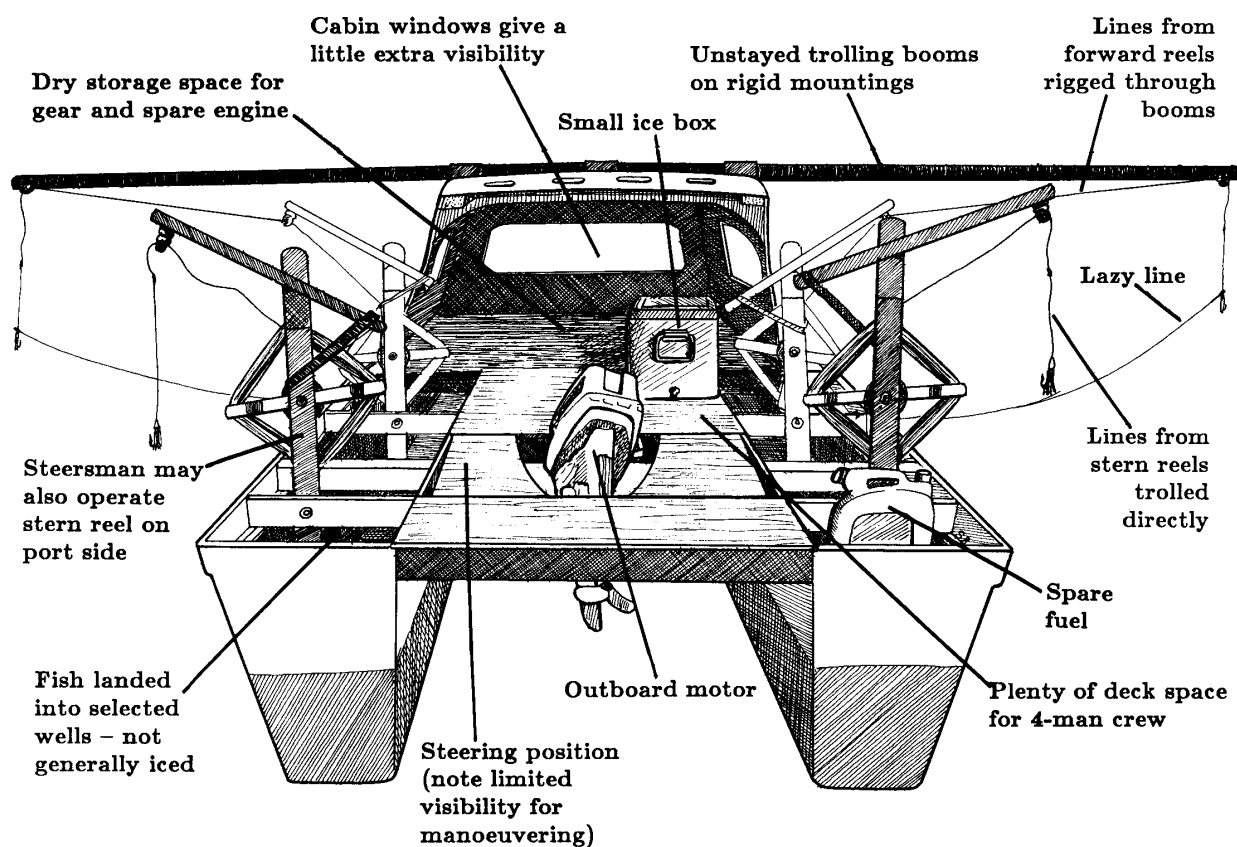

8.5-METRE (28-FOOT) OUTBOARD-POWERED 'ALIA' CATAMARAN

CHAPTER 2: PREPARING A TROLLING BOAT
SECTION I: TWO COMMERCIAL FISHING ARRANGEMENTS

8.5m (28') monohull

This boat has more comfortable accommodation and is better suited for longer trips of several days. It has a much larger carrying capacity and can be loaded up with one or more heavy ice boxes. The usual engine unit is a Yanmar 2QM20 (20 horsepower) or 3QM30 (30 horsepower) inboard diesel, which is reliable and economical. With a 200 litre (45 gallon) fuel tank this boat has a fishing range of several hundred kilometres (or miles).

Rigged with two steering positions as shown, one man can comfortably operate and fish this boat alone if necessary.

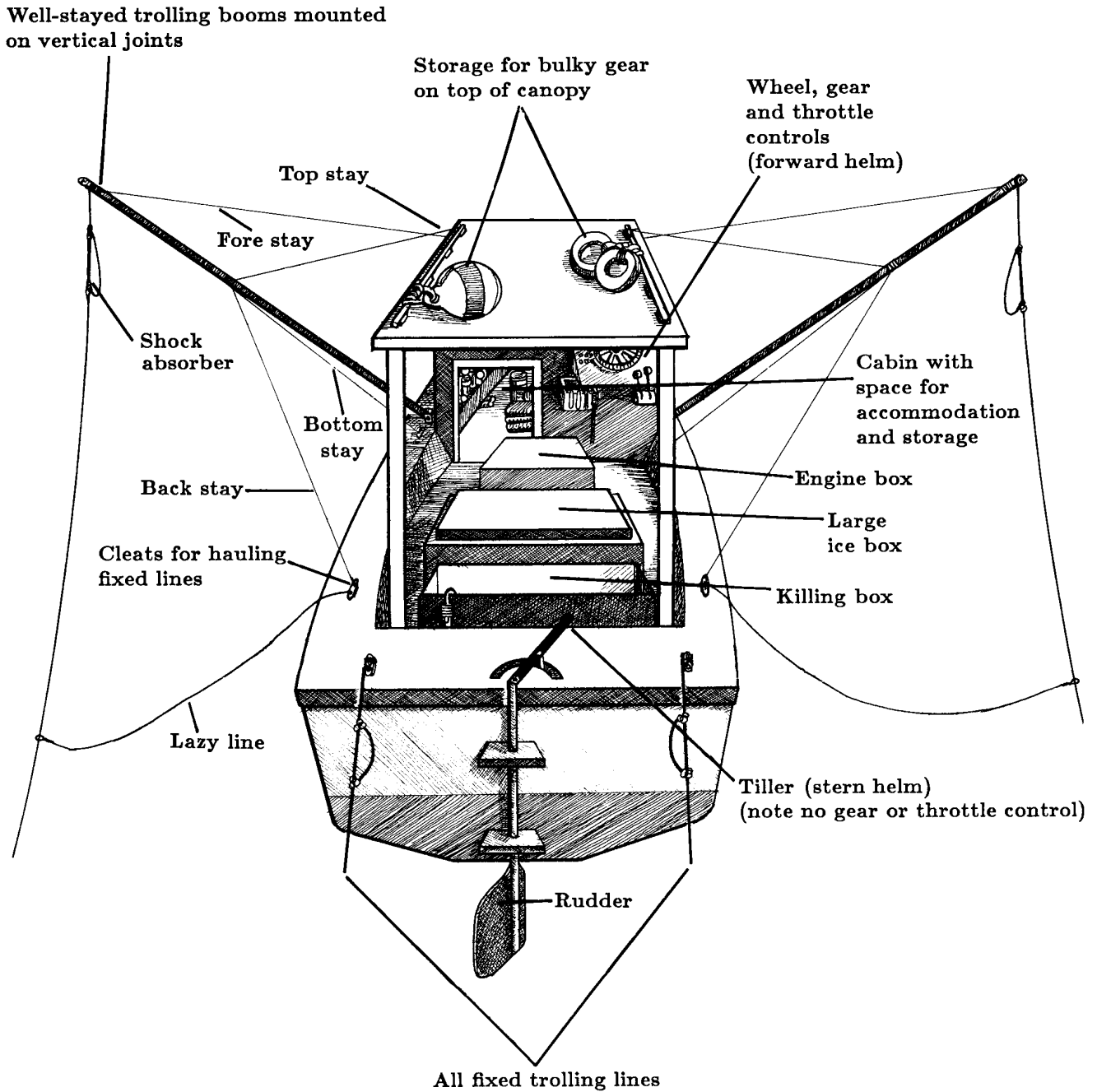

8.5-METRE (28-FOOT) INBOARD DIESEL-POWERED V-BOTTOM MONOHULL

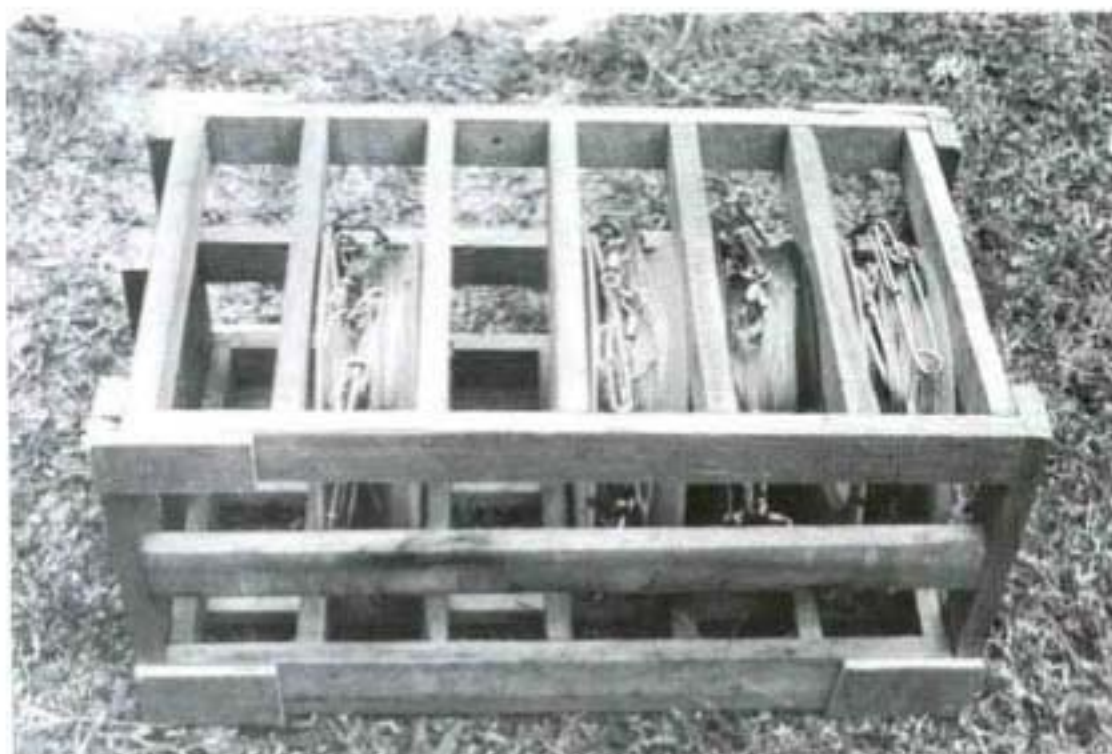

Location

Photo: P. C. Mead

A home-made rack for storing lines on handcasters



Location: Apia, Western Samoa

Photo: L. B. Chapman

Straightening out a line tangle

CHAPTER 3

PREPARING TROLLING LINES

A. TOOLS AND UTENSILS

B. HOOKS -*Hook types -Sharpening hooks -Ganging hooks*

C. TYPES OF FISHING LINE -*Handling lines -Line characteristics*

D. END LOOPS IN LINE AND SINGLE-STRAND WIRE -*Double figure-eight knot -Using end loops
-End loops in wire*

E. END LOOPS IN ROPE -*Whipping and sealing rope ends -Bowline knot -Eye splice*

F. END LOOPS IN CABLE (MULTI-STRAND WIRE) -*Wrapped end loops -Flemish eye
-Crimping cable -Lazy splice*

G. KNOTS FOR HOOKS AND TACKLE -*Palomar knot -Slip knot -Clinch knot -'Trilene' knot
-Tying a hook rigid on wire*

H. JOINING LINES TOGETHER -*Blood knot (Barrel knot) -Double slip knot -Using end loops
-Connector rings and swivels*

I. THE ASSEMBLED TROLLING LINE -*The mainline -The trace -Changing traces- Trace length
-The backing*

J. SINKERS -*Heavier line materials -Sinkers -Downriggers -Cannonballs*

K. DIVING DEVICES -*Diving boards -Tripping -Diving lures -Trolling depth*

L. RIGGING FIXED LINES -*Making shock absorbers -Rigging shock absorbers -Position
-Backing cord and lazy line -Line storage*

M. RIGGING LINES ON HAND REELS -*Loading the reel -Overloading -Adjustments -Using wire*

N. RIGGING HANDREELS FOR TROLLING -*Rigging through a trolling boom -Rabbit line
-Boom stays -Braking system (drag) -Lazy line*

CHAPTER 3: PREPARING TROLLING LINES

SECTION A: TOOLS AND UTENSILS

Most of the preparation for trolling is normally done on shore before the fishing trip starts. This makes gear rigging easier and more comfortable, prevents new materials being contaminated with salt water before they are used, and avoids wasting time at sea which could better be used in fishing or carrying out other tasks on the boat. Gear rigging is time consuming, and mastering some of the techniques, particularly when working with wires, requires plenty of patience. However, gear rigging principles are easily learned, and will develop with practice.

The most important thing about gear rigging is to have on hand the right tools and materials for the job. The tools needed will vary depending on the materials being used, but are mostly general purpose items available through hardware or other retail stores.

For working with nylon, only basic tools are needed. These include a pair of standard pliers, a good knife and a sharpening stone (oilstone or whetstone). Sharpen knives regularly.

If using wire, you will also need a pair of wire cutters or snips. Cutters are preferred as these can be sharpened using a small file. For cable you may also need crimping pliers and crimps or sleeves of the correct size.

WORKING WITH WIRE

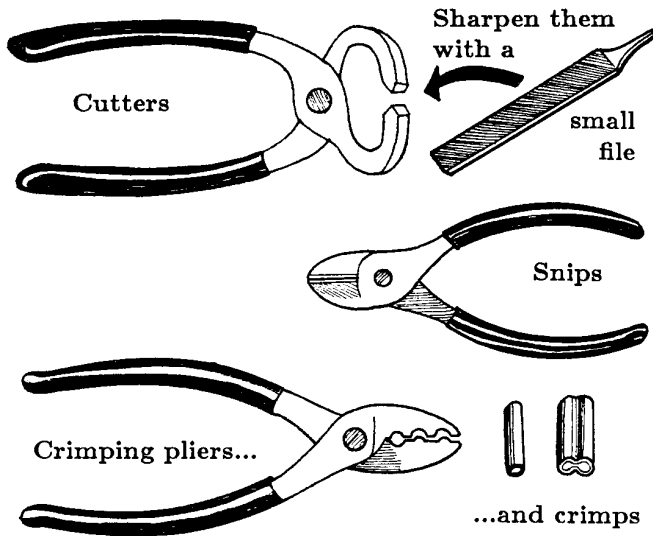

For cleaning and sharpening hooks, emery or glass paper and a small flat or three-cornered file are required. (See Section 3B.)

HOOK MAINTENANCE

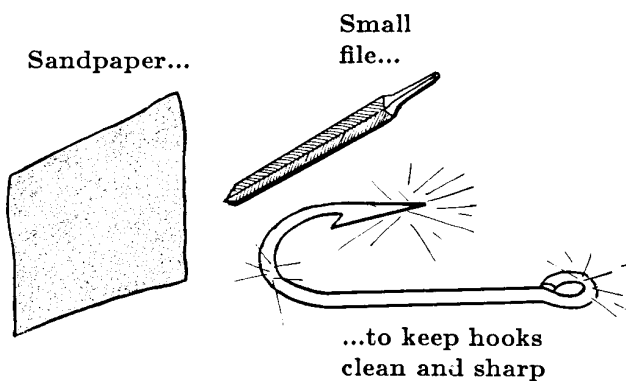

WORKING WITH NYLON MONOFILAMENT

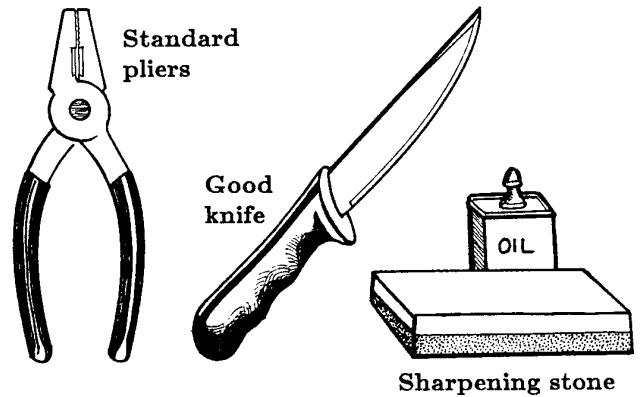

For general work with ropes and lines, it is useful to have on hand adhesive tape, light string or twine, and, if available, waxed dental floss. These are used for whipping rope ends, temporarily attaching or holding line, etc.

GENERAL ROPE WORK

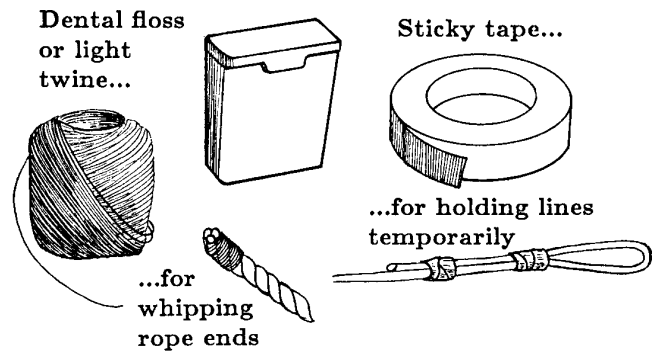

When rigging octopus lures, use waxed dental floss or cotton for tying on lure skirts or other materials. (See Section 4G.)

RIGGING OCTOPUS LURES

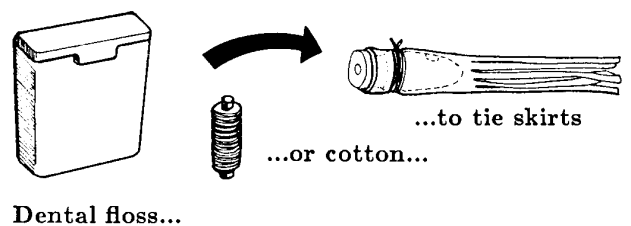

For rigging some kinds of natural bait, you may need soft copper or other tie wire to stop the mouth opening, or to tie the head snugly against the line.

FOR SOME TYPES OF BAIT

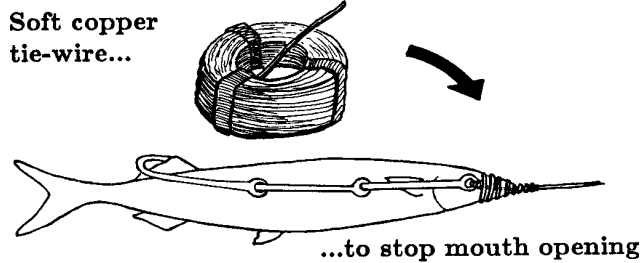

For hard lures, changing hooks may require a screwdriver or small spanner (wrench), and soft tie-wire of copper, monel, or other corrosion-resistant metal. Model or auto paint, or nail varnish in bright colours is also useful for touching up damaged lures. Metal polish can be used to restore the shine on reflective metal lures.

To keep all metallic gear -hooks, cable, hard lures, etc. - and tools in good condition, wipe or wash off any salt water after use and oil well. Use ordinary motor oil or spray-on water repellent lubricant (CRC, WD-40, etc.). Reject oil drained from motor engines is also perfectly okay.

HARD LURES

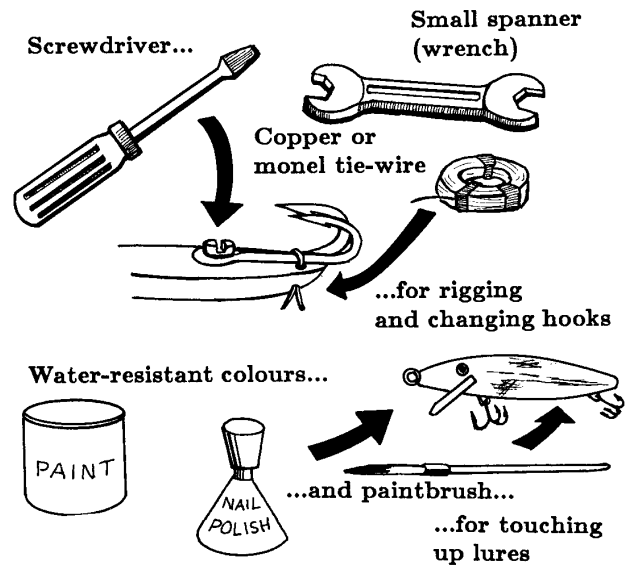

For the storage of completed lines and traces, plastic or wooden handcasters are useful and can be improvised if not readily available. The diameter should be large enough (about 15cm, or 6 inches, at least) to ensure that lines do not kink or bend. Try not to use wooden frame line holders, as these tend to kink the lines, especially when used with wire.

METAL GEAR AND TACKLE

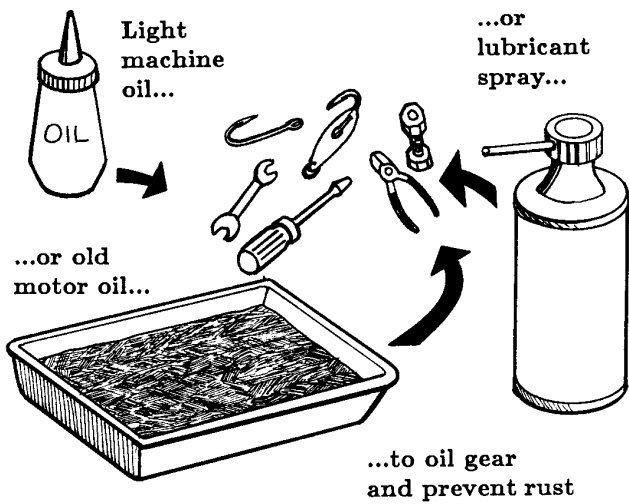

LINE STORAGE

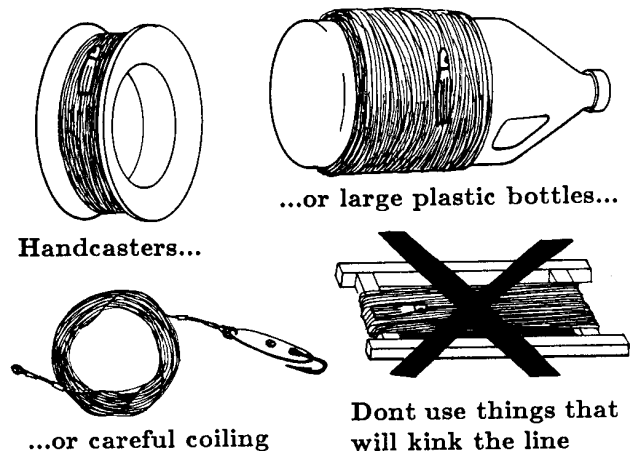

In addition to these tools and utensils, you will need a variety of materials with which to work. These are described in the following sections, and include lines and wire (section 3C), hooks (3B), swivels and rings (3H), sinkers or downriggers (3J and 3K), and baits and lures (4A-H).

FISHING MATERIALS

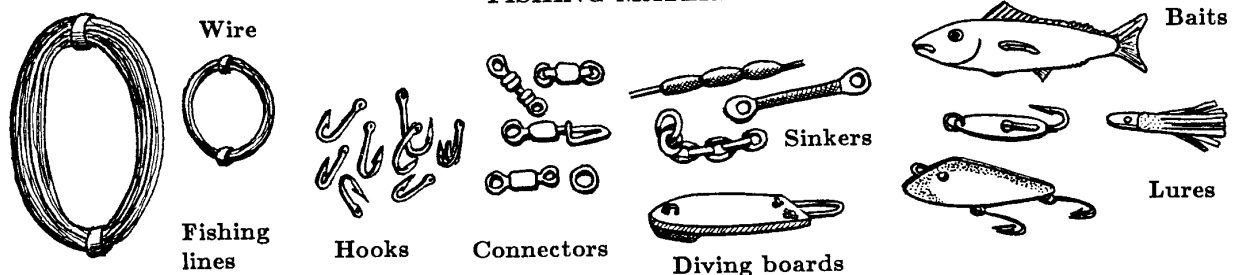

CHAPTER 3: PREPARING TROLLING LINES

SECTION B: HOOKS

The hook has two functions -to catch the fish, and then to retain it until it is safely on board the boat. To catch the fish, the hook has to be of the right shape so that the point will catch in the fish's mouth, gills or stomach. The point has to be hard enough and sharp enough to penetrate through hard skin and bone. The shank and the bend of the hook have to be solid and strong enough to take the impact of the striking fish, and its struggles to break free, without snapping or straightening.

As well as being strong and sharp, a good trolling hook will be rust-resistant for long life, and smooth, so as not to act as a saw and cut its way out of the fish. Most trolling hooks are barbed to prevent the hooks being thrown by a fighting fish. However for some types of trolling, such as for surface-feeding tunas, barbless hooks can be used and will speed up the fishing operation.

Hook types

The three main styles of hook -single, double and treble -are each available in a wide variety of materials, shapes and sizes:

SINGLE HOOKS -Choose heavy gauge hooks with a long straight shank, deep throat, wide jaw and slightly off-set point. Slightly incurved hooks (tarpon hooks) are used by many game fishermen, but strongly incurved hooks, like the tuna circle, are not suitable because the point does not sink itself when the fish strikes. Stick the hook under a table or in a door post and try to bend it open by hand. If you can, it is too weak for use in commercial trolling.

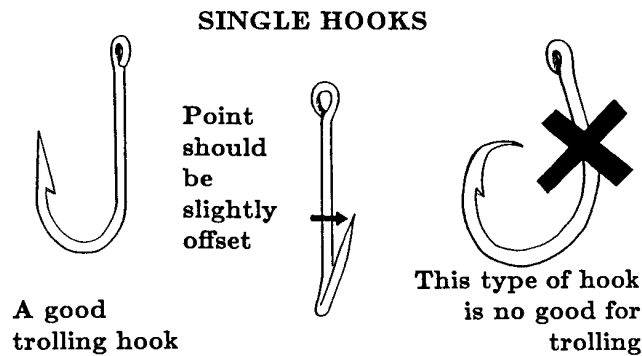

TRIPLE HOOKS -These are always welded and usually available only in smaller sizes. They are very efficient for small fish with a large bite, but are not recommended for commercial use.

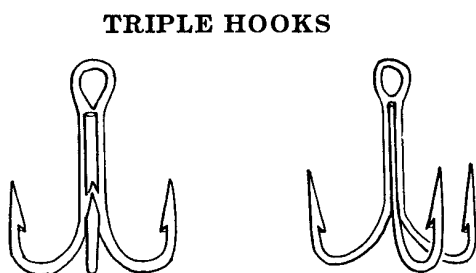

PARTS OF A HOOK

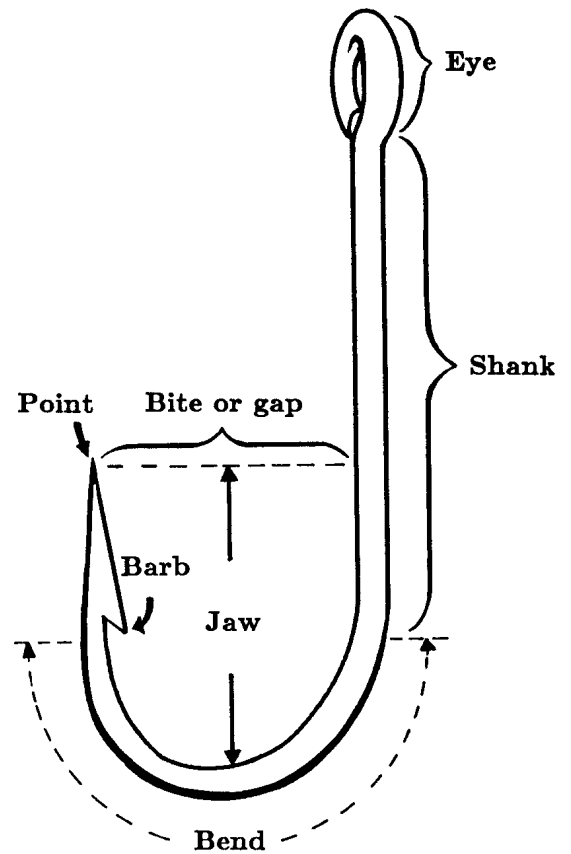

DOUBLE HOOKS -Welded hooks are stronger than unwelded ones, but are usually more expensive. Unwelded hooks are more likely to spread, but are also easier to change on some types of lure. Barbless double hooks are preferred by some tuna fishermen as the fish can be quickly unhooked, but barbed hooks are much better for general use.

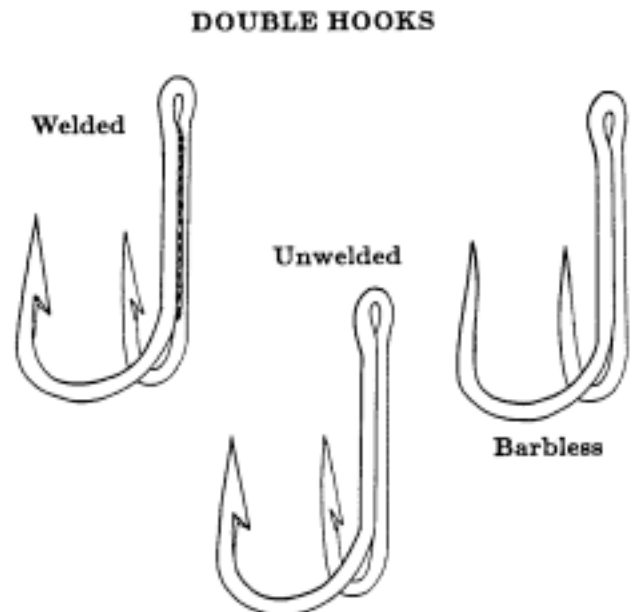

Sharpening Hooks

The sharpness of a hook makes a huge difference to its performance. Always check the points of your hooks before use, to ensure they are sharp and not too rusty. If necessary sharpen them with a small three-cornered file and abrasive paper. A properly sharpened hook should leave a clear, fine scratch when drawn across your thumbnail.

SHARPENING HOOKS

Use a file and fine sandpaper to remove rust and to sharpen the point

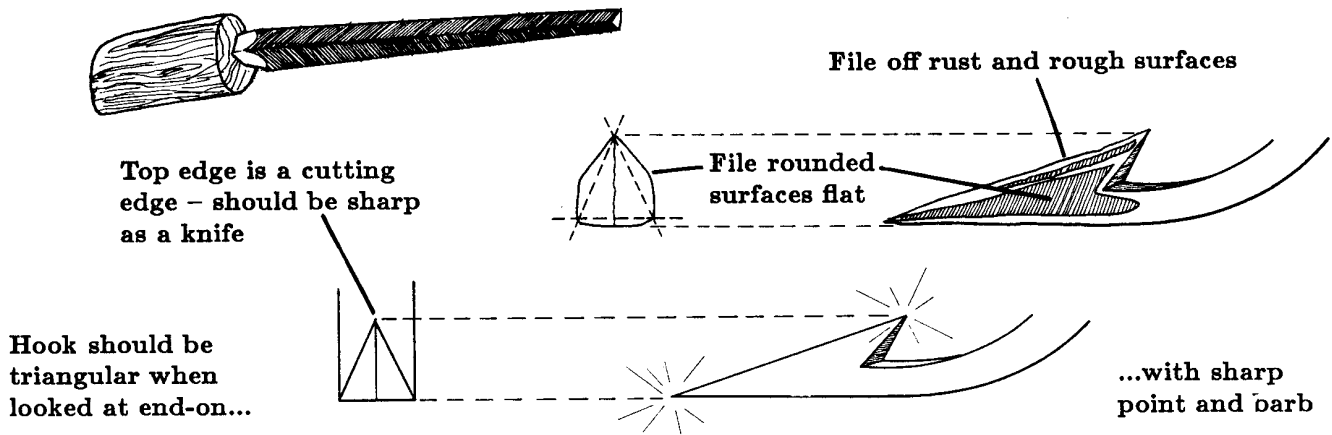

Ganging hook:

For rigging natural baits (see sections 4B -4F), it may be necessary to 'gang' two or more single hooks, that is to join them in a string so that when a fish strikes the bait there is more chance of it being hooked. (Some manufacturers, sell hooks already ganged). For ganging, try to use hooks with large eyes that can be easily separated if a fish is hooked too well. The chances of the hooks coming apart by accident during trolling are small.

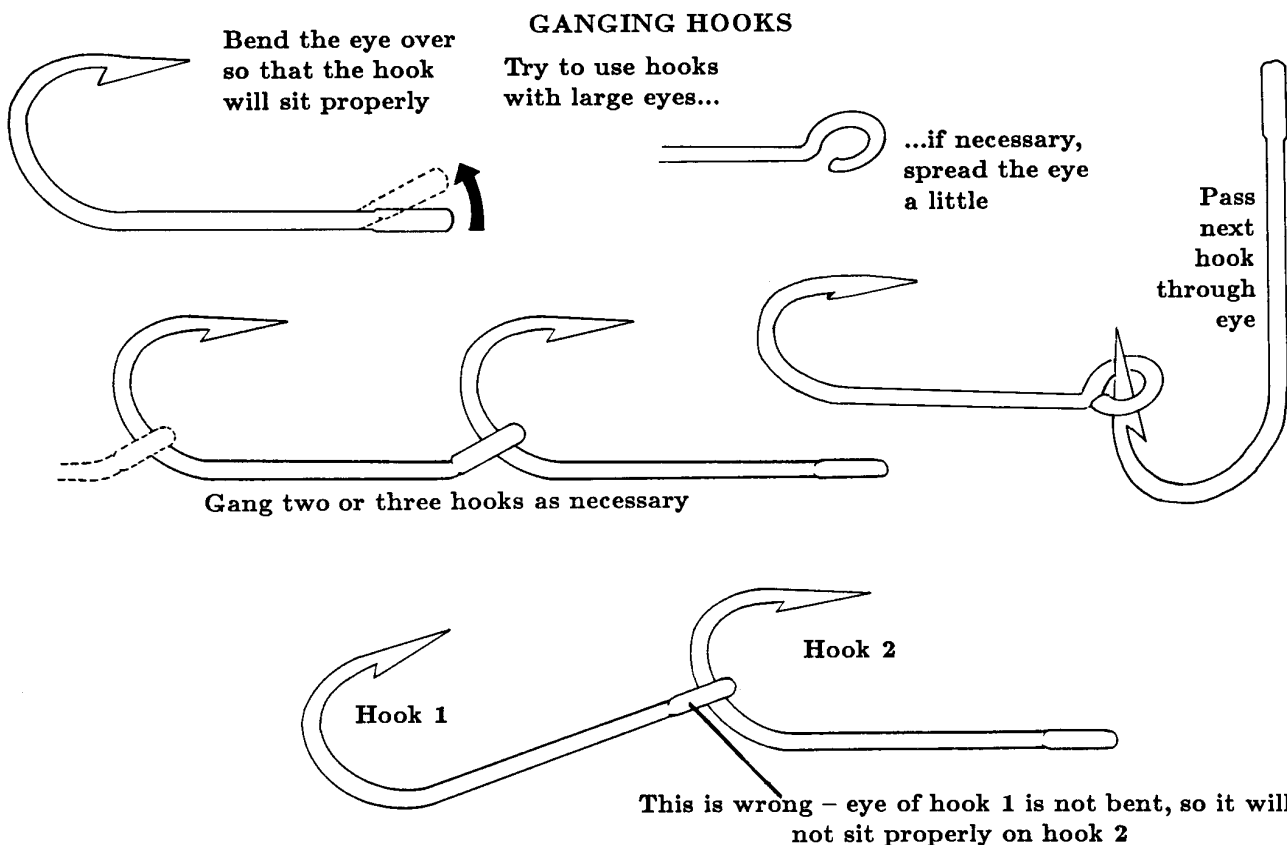

CHAPTER 3: PREPARING TROLLING LINES

SECTION C: TYPES OF FISHING LINE

A very wide variety of monofilament and multifilament lines are available in a variety of materials, including natural fibres, plastics and other synthetic fibres, and metals. The main types of line are defined in Section 1B, and illustrated below.

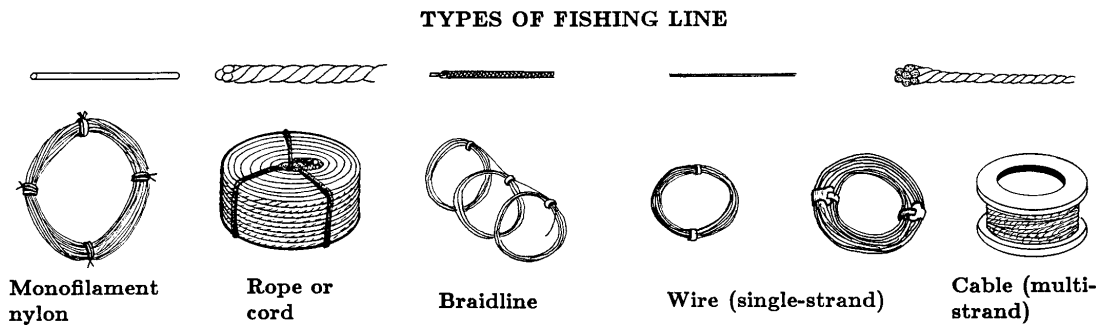

The characteristics and properties of some of the line types more commonly used for trolling are shown in the table on the facing page.

Handling lines

A line is in its natural state when it is laid out straight and under slight tension. At other times, such as when coiled, flaked on deck, etc., careful handling is required to avoid tangles, kinks and knots which will diminish its performance. In particular:

Don't allow wire or cable to get twisted, curled or kinked by bad storage and handling. This can easily result in line breakage.

Don't allow unnecessary knots to develop in lines. Knots can weaken a line to 50 percent or less of its original strength. If a line get knotted, decide whether to throw it away or cut out the knot and re-join the line as shown in Section 3H. Never pull tangled lines tight if you can avoid it.

Don't expose lines unnecessarily to the weather. Sunlight causes deterioration in synthetic lines; water and bacterial growth rot natural fibres; salt water rusts wires and cables. Leave new lines on shore until they are needed.

Do check lines regularly for condition. Look for surface abrasions, cuts, flattening of the line, wear, fraying, rusting, knots, and oil contamination. Decide whether the wear point has been significantly weakened. If so, repair or replace it.

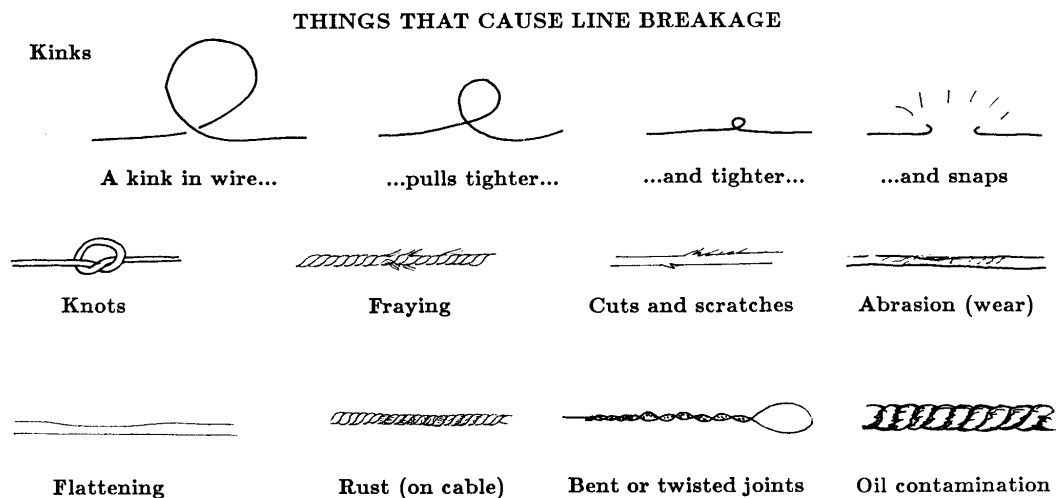

Remember: a weakened line will break at the time when it is under the greatest strain -with a big fish on the end of it.

CHARACTERISTICS OF MAIN TYPES OF TROLLING LINE

Type of line/ <i>Main uses</i>		Advantages	Disadvantages
Lines	Monofilament nylon <i>Mainlines and traces</i>	Good strength for diameter. Comes in many sizes. Can easily be tied and knotted. Very elastic, sets hook well. Smooth surface, low drag in water. Usually quite cheap. Widely available. Low visibility in water.	Very easily cut. Very springy and will tangle easily. Can become kinked, making handling and use difficult. Smooth surface is hard to grip, especially when wet. Knots liable to slip.
	Multi-strand (3-ply) monofilament nylon <i>Mainlines</i>	Similar characteristics to ordinary monofilament nylon but:	
		Easier to grip. Less liable to tangle. More elastic.	Creates more drag in water. Takes up much more space on a reel. Not widely available. (Usually used for snoods by longliners.) Difficult to knot.
	Twine, cord or rope <i>Backing cords, mainlines</i>	Often cheaper than monofilament. Can be highly elastic. Lies flat when flaked - less likely to tangle. Easily knotted and tied. Wide range of sizes. Usually widely available. Easy to grip.	Cuts fairly easily under tension. High drag in water. Wears out faster than nylon. Weaker than monofilament of same size. May rot. High visibility in water.
Braidline (e.g. Super-toto) <i>Mainlines</i>	Very strong. Lies flat when flaked. Less liable to tangle. Resistant to abrasion and cutting. Easily knotted and tied. Easy to grip.	Very expensive. Not widely available. High drag in water. High visibility in water.	
Wires	Piano wire <i>Traces</i>	Strong for diameter. Range of sizes available. Inexpensive. Very resistant to cutting. Can be joined without crimps. Low drag in water.	Inelastic. Brittle, breaks easily if kinked. Rusts. Difficult to handle. May not be locally available.
	Single-strand stainless steel wire <i>Traces</i>	Similar characteristics to piano wire, but:	
	Does not rust. Usually widely available.	Moderately expensive. Kinks easily. Springy and very hard to handle.	
Cables	Galvanised Bowden cable <i>Traces</i>	Fairly strong for diameter. Smooth surface, low drag in water. Not prone to kinking. Does not harden with use. Lies flat; easy to handle.	Rusts (Note: Should not be washed in fresh water as this accelerates rust). Requires crimps. May not be locally available.
	Galvanised 9-strand (3x3) steel cable (e.g. Turimoto longline wire) <i>Mainlines, traces</i>	Strong for diameter. Usually inexpensive. Resists twisting and kinking. Can be joined without crimps.	Rusts. Fairly high drag in water. Only available in limited number of sizes. May not be locally available.
	7-strand and 49-strand (7x7) stainless steel cable <i>Mainlines, traces</i>	Strong for diameter. Lies flat and relatively easy to handle. Moderately resistant to twisting or kinking. Many sizes available.	Expensive. May rust or corrode if used with dissimilar metals. Frays with wear, becoming difficult and painful to handle. Breaks if twisted badly.

CHAPTER 3: PREPARING TROLLING LINES

SECTION D: END LOOPS IN LINE AND SINGLE-STRAND WIRE

End loops are needed to join lines to each other and to hooks, swivels, etc. To do their job they must be tied securely so as not to slip, pull tight, or come undone. This and the following sections show ways to make and use end loops in a variety of materials normally used in trolling lines.

Double figure eight knot

This knot is the most useful for making end loops in all types of light line and will hold well even in nylon monofilament.

Using end loops

Hooks, swivels, and other tackle can be simply attached to monofilament line by threading onto the line before making the loop.

Alternatively, they can be attached by passing the completed loop through the hook or swivel eye, and then around the body. This enables tackle to be disconnected and changed easily.

DOUBLE FIGURE-8 KNOT

Double end of line over...



...pass doubled end around standing part of line...



...and back through loop

ATTACHING TACKLE USING END LOOPS

Thread line through eye before making loop...

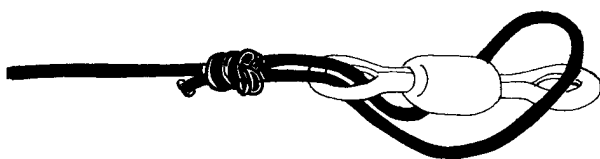

...pull tight, making sure line falls into right position

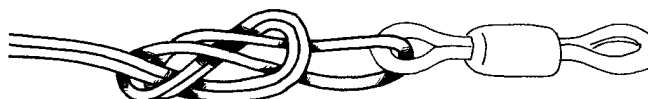

...or, thread loop through eye...



No good. Line may interfere with action of swivel

Lines can also be joined together using end loops (see Section 3H). End loops are made on the ends of each of the two lines to be joined, and one loop passed through the other in the manner shown. This method is most useful for joining lines when one of them is fairly short, for instance in attaching traces to mainlines.

JOINING LINES USING END LOOPS

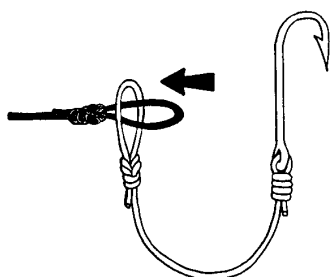

Pass first loop through second

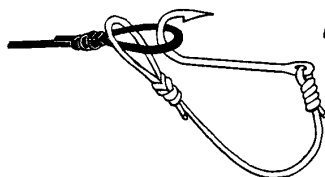

Pass end of second line back through first loop

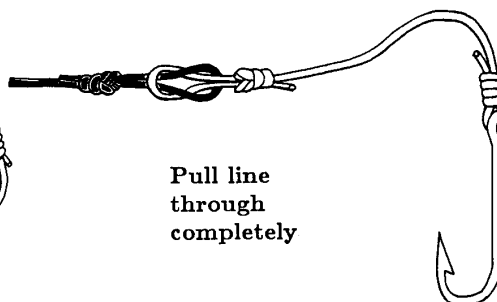

Pull line through completely

End loops in wire

Unlike lines and ropes, most wires and cables cannot be reliably knotted. The most usual way of making end loops in single-strand wire is by making a haywire twist, followed by a barrel twist, as shown below.

(1) Take a bend in the wire to form an eye or loop. Make sure you leave enough of a tag end to work with about 15cm (6 inches) or so.

TWISTED END LOOP FOR WIRE

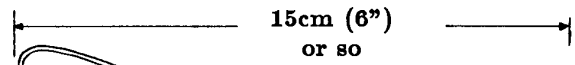

1) Bend wire back over itself to form loop

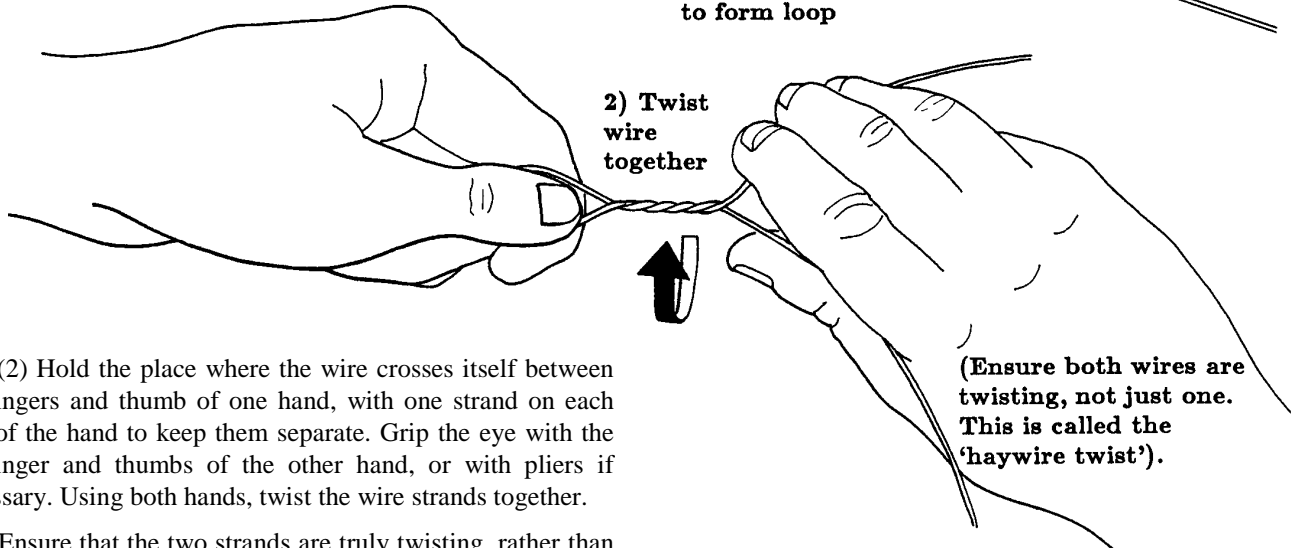

(2) Hold the place where the wire crosses itself between the fingers and thumb of one hand, with one strand on each side of the hand to keep them separate. Grip the eye with the forefinger and thumbs of the other hand, or with pliers if necessary. Using both hands, twist the wire strands together.

Ensure that the two strands are truly twisting, rather than one staying straight and the other wrapping around it. Continue until the twist is 3-5cm (1-2 inches) long. This is called a haywire twist.

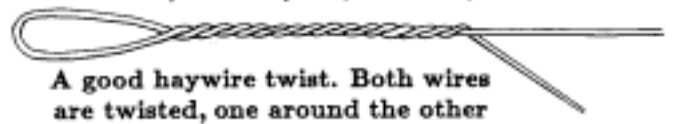
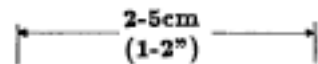

A good haywire twist. Both wires are twisted, one around the other



No good. One wire is twisted, the other is still straight

3) Wrap the tag end around 3 or 4 times, then bend over

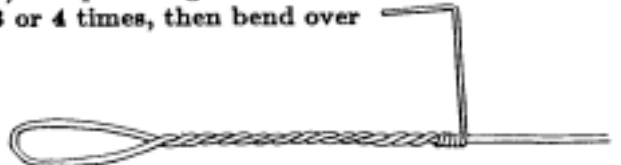

(3) Next, make a tight finishing twist by wrapping the tag end around the main strand three or four times.

(4) Bend the tag end over at right angles about an inch from the final wrap. Twist it around several times, and it will break cleanly leaving a rounded end which will not scratch or cut your hands. As an alternative, the tag end can be snapped off with pliers or wire cutters, but this will leave a sharp point which can cause a surprisingly deep cut in a hand or finger.

4) Break tag end by twisting it around in a circle 2 or 3 times

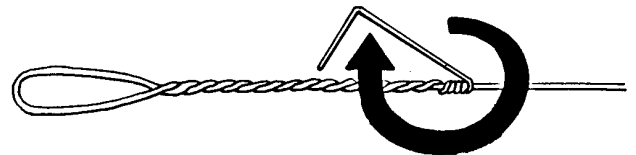

5) Finished loop should be neat and tag end should not leave a sharp point



(5) The finished loop should be straight and regular with both strands properly twisted. If one strand is straight with the other wrapped around it, the twist will not hold but will slip and may break when a load is placed on the loop.

CHAPTER 3: PREPARING TROLLING LINES

SECTION E: END LOOPS IN ROPE

Twines and light ropes may be used for parts of the trolling line, particularly the backing and the mainline (see Section 31). Heavier cords and ropes are used for various jobs around the boat, including mooring, anchoring, and tying down loose objects. Knowing how to tie (and untie) proper knots and make simple splices are essential skills for any fisherman.

Whipping and sealing rope ends

Tying and untying knots or making splices in ropes can be difficult if the rope ends are frayed or ragged. Since the ends of most ropes will fray very quickly when they are cut, it is usually necessary to whip them before working with them.

The easiest way is to tightly bind the end of the rope, or the tips of individual rope strands, using adhesive tape or rubber bands. This method is only temporary, since the tape or elastic will soon fall off. However, it is fine for making splices, as the condition of the rope ends is not important once the splice is finished.

For more permanent ends, the rope should be bound tightly as shown, using light twine. The best twines for this purpose are waxed to ensure a good grip.

For synthetic rope, heat end with a match to melt it...

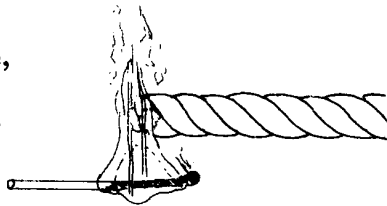

...then twist melted strands together

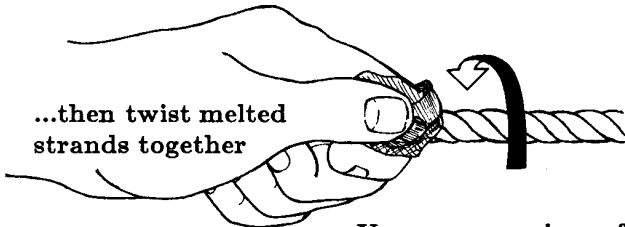

Use a rag or piece of paper to protect your fingers from the heat

Bowline knot

This knot is good for ropes and for heavier lines which grip well. The bowline is strong, will not slip and is fairly easy to undo when necessary. It is not good for slippery lines and will not hold in nylon monofilament.

BOWLINE KNOT

Make loop in rope...

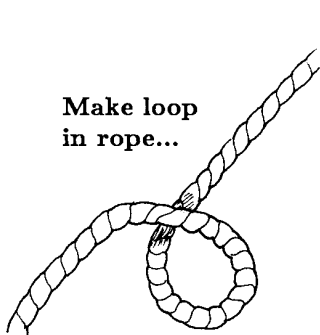

...pass end through loop, around rope...

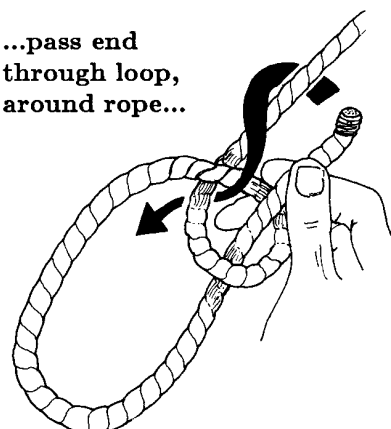

...and back through loop, pull tight

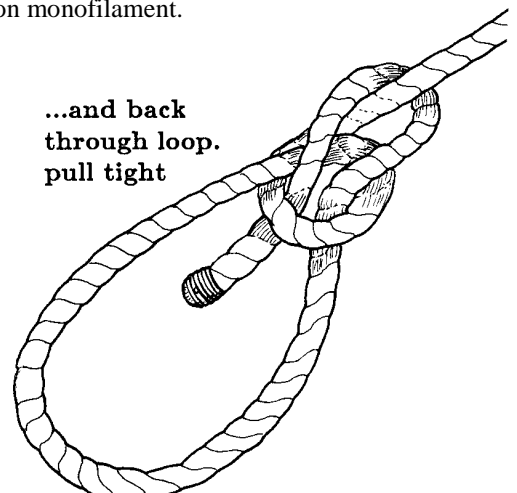

SEALING ROPE ENDS

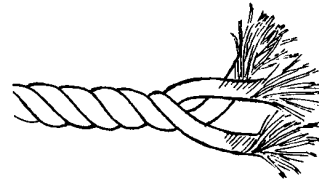

Cut ends of rope will fray if not sealed

For temporary holding, tie up...

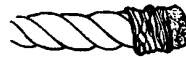

...with cotton, rubber bands...

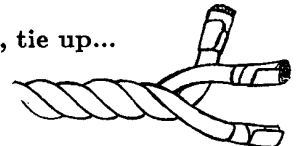

...or sticky tape

For more permanent holding, whip using light twine or dental floss

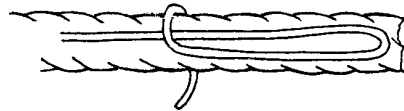

Lay loop of twine along rope...

...wrap tightly.

Pass end of twine back through loop...

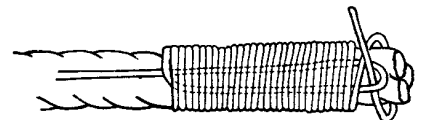

...use other end to pull loop under wrapping. Cut off both ends

With some synthetic ropes, a short cut is to melt the rope end into a solid plug. To do this, hold the rope end in a match or lighter flame until it becomes sticky, then twist the end tight using a folded piece of greaseproof paper.

Eye splice

For permanent end loops in ropes, eye splices are much better than knots. They take more time and effort to make, but are far stronger, and will not become snagged or caught up as easily as a knotted line will.

To make an eye splice, first whip the ends of each strand of the rope. It may be helpful to number the ends, or to mark them with different colours.

Unlay the ends until you have enough length to work with – about 20-25 cm (8-10 inches) is enough for 12mm (1/2-inch) diameter rope. With some ropes, it may be necessary to tie or tape the strands together to prevent them unlaying too far.

Double the rope back so that the finished eye will be the size that you want. Form the eye and spread the strands fanwise, placing them against the rope where it is to be entered. Untwist the body of the rope a little and pass the centre end under the centre strand. Then, pass the left end under the next rope strand to the left and the right end under the next strand to the right. If the rope is hard-laid, you may need a spike or fid to help you separate the strands widely enough.

For splicing hard-laid ropes...



...you may need a spike or 'fid'

If this has been done correctly all three ends should be sticking out at the same level, evenly spaced around the main body of the rope. If they are not like this, pull them out and start again.

Continuing the splice is easier than starting it. Pull the first tucks tight, then take any end and pass it over the next strand and under the one after. Repeat for the other two ends, so that each shows two tucks in the main body of the rope. The ends should still be even and regular.

Repeat this procedure until each strand has 3 or 4 tucks, then cut off the ends close to the body of the rope.

To make a tapered splice...

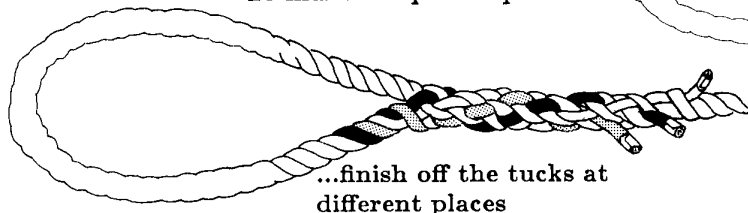

...finish off the tucks at different places

With slippery ropes, or those which fray badly, it is worth whipping the splice to ensure that the ends never slip back through the strands.

THE EYE SPLICE

Unlay the rope into 3 strands

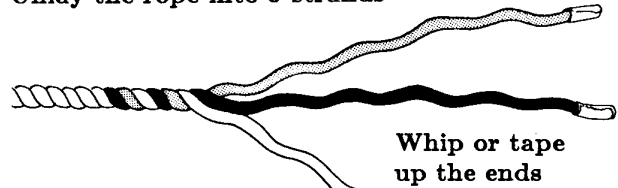

Whip or tape up the ends

Turn the rope to give the size of loop you want

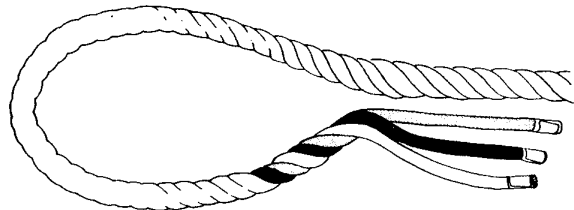

Pass the ends under the lay of the rope

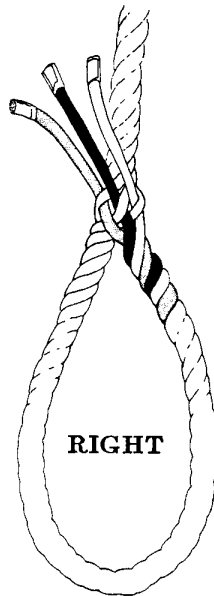

RIGHT

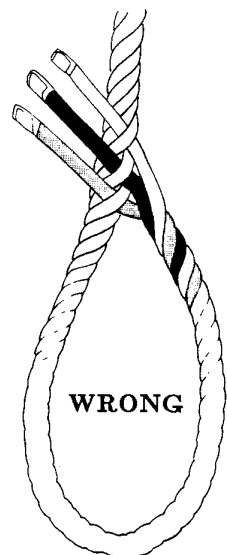

WRONG

Tuck each end over one strand and under the next. Do this three times

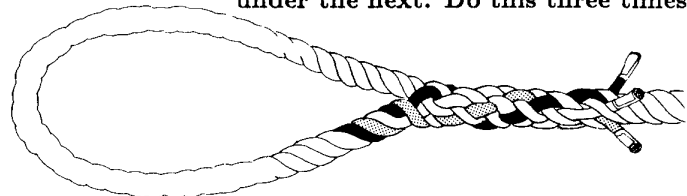

To make a tapered splice, make additional tucks with two of the ends so that all three finish at different places, then cut off.

Cut off the ends and whip the splice

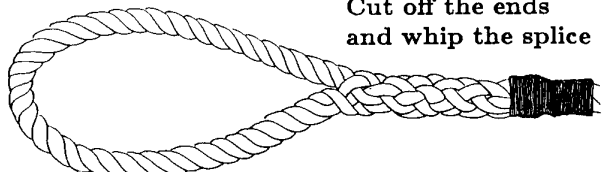

CHAPTER 3: PREPARING TROLLING LINES

SECTION F: END LOOPS IN CABLE (MULTI-STRAND WIRE)

Multi-strand wire, or cable, cannot be reliably knotted. Eye splices can be spliced in the same way as for rope (see section 3E) but the procedure is slow and fiddly for small wire, and requires a workbench, vice and various tools for heavier cable. This section shows some easier ways to make end loops in multi-strand wire.

Wrapped end loops

Some multi-strand wires, such as Turimoto galvanized longline wire, can be wrapped in a similar way to single-strand wire (see section 3D). Only the finishing procedure is different.

Make the eye and haywire twist as for the single-strand wire (section 3D). To finish, separate the cable so that the three major strands (which each consists of three minor strands) can be handled individually. Wrap one major strand tightly three or four times around the main strand. Next, separate it into three minor strands, and cut these off flush with the standing part of the wire (or break them off individually as for single-strand wire).

Take the second major strand and repeat the process, wrapping it tightly around the standing part of the wire and covering up the ends of the first wrap. Cut or break off the ends. Finally repeat the procedure with the last major strand, covering up the ends of the second. The finished product should have a regular shape and no sharp ends sticking out. If sharp ends protrude at any point during the wrapping procedure, twist them down with a pair of pliers.

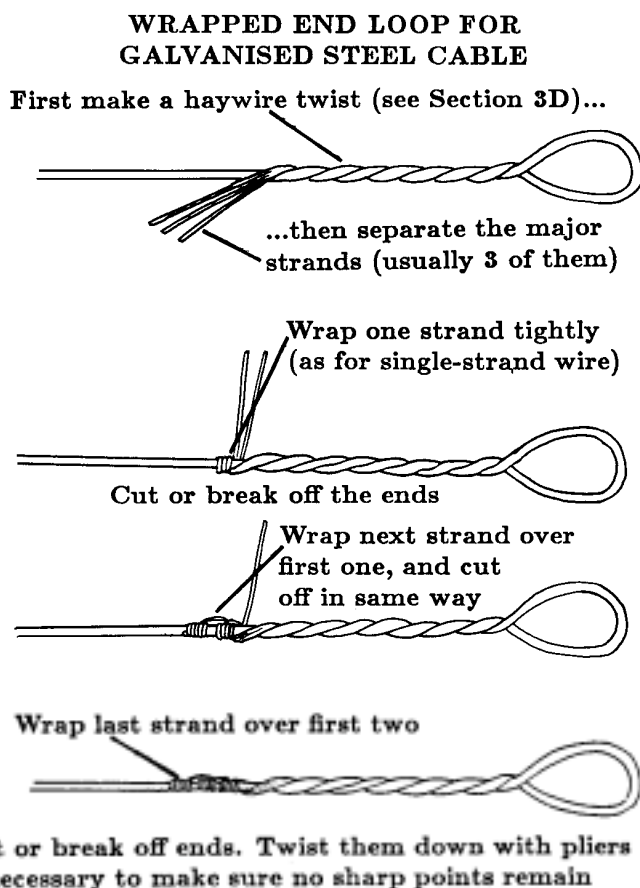

Flemish eye

To strengthen an end loop in cable, and reduce the likelihood of it untwisting, you can make a 'flemish eye'. To do this, tie an ordinary overhand knot in the cable, pulling the knot tight until the eye is about the size you want it. Pass the tag end back through the knot once more and start wrapping as above. The finished product is a stronger and more rigid end loop.

FLEMISH EYE

To make the flemish eye...

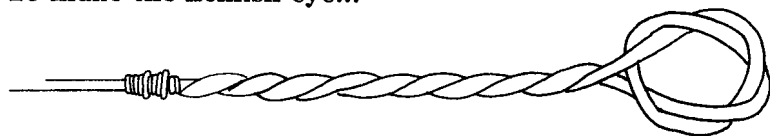

...tie a double overhand knot in the cable before completing the end loop

Crimping cable

A simple way to make end loops in multi-strand wire is to crimp them using metal sleeves and crimping pliers. Always use two sleeves and ensure that they are the right size for the wire. Slide the sleeves onto the wire and then tie a flemish eye as shown above. Pass the tag end through the first sleeve, push the sleeve hard against the flemish eye, and crimp it tightly shut using the pliers. Wrap the tag end slightly around the main strand and crimp the other sleeve over the end, making sure the two strands are tight together and the end does not stick out.



Crimps or sleeves the right size for the wire you are using

CRIMPING END LOOPS

Always use two crimps 2-5cm (1-2") apart

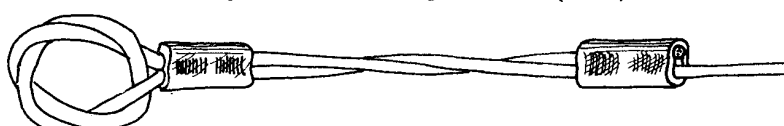

Never leave tag end sticking out

Lazy splice

The lazy splice is an imitation of a true eye splice, but is much quicker and easier to do. It is a good way to make an end loop in 49-strand stainless steel wire if you have no crimps or sleeves available.

First, using your thumbnail, a nail or a hook point, split the body of the wire into two roughly equal halves. Unwind them back about 10-15cm (4-6 inches) or more depending on the size of the eye you want to make.

LAZY SPLICE FOR MULTI-STRAND WIRE

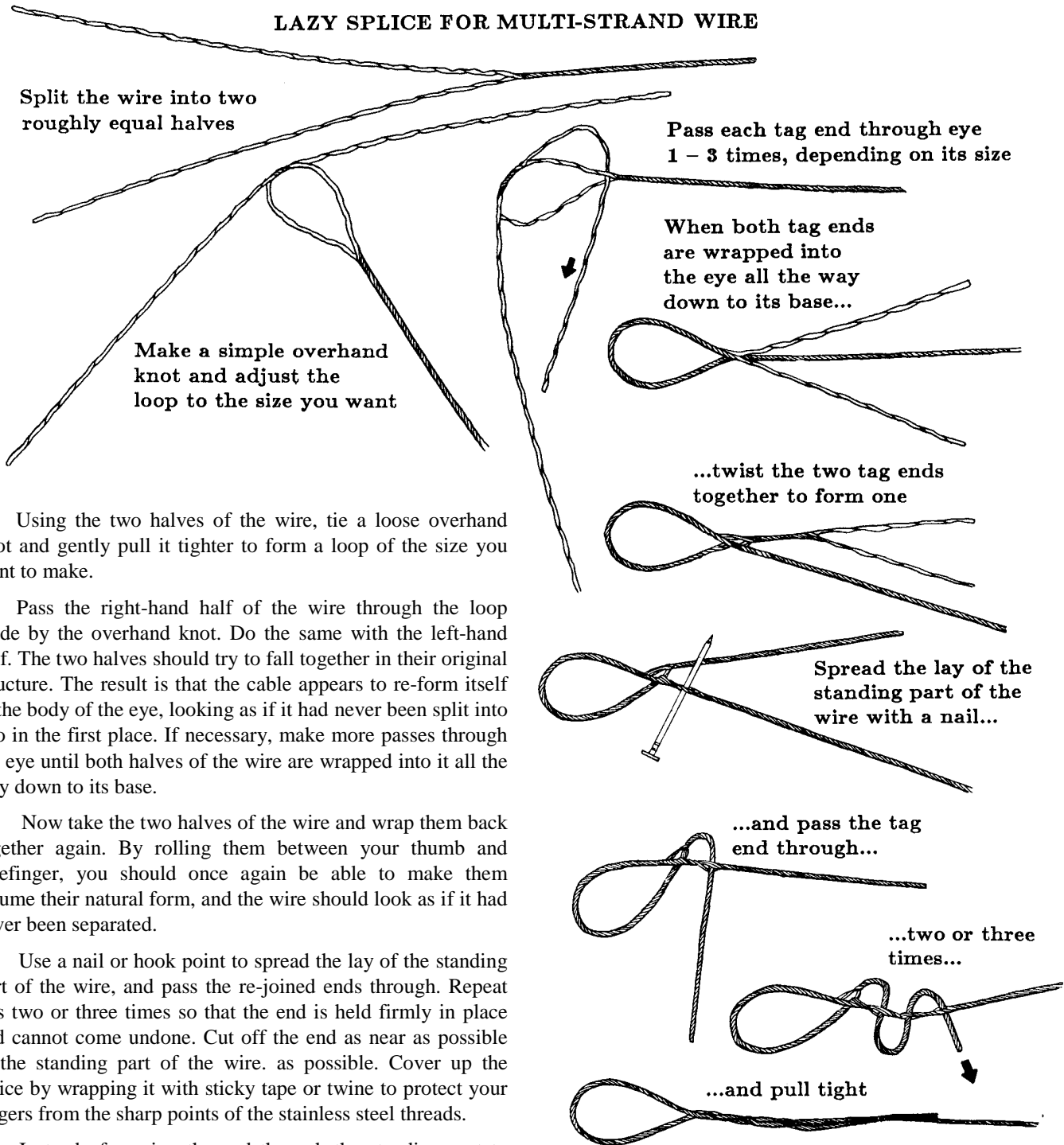

Split the wire into two roughly equal halves

Pass each tag end through eye 1 – 3 times, depending on its size

Make a simple overhand knot and adjust the loop to the size you want

When both tag ends are wrapped into the eye all the way down to its base...

...twist the two tag ends together to form one

Spread the lay of the standing part of the wire with a nail...

...and pass the tag end through...

...two or three times...

...and pull tight

Using the two halves of the wire, tie a loose overhand knot and gently pull it tighter to form a loop of the size you want to make.

Pass the right-hand half of the wire through the loop made by the overhand knot. Do the same with the left-hand half. The two halves should try to fall together in their original structure. The result is that the cable appears to re-form itself in the body of the eye, looking as if it had never been split into two in the first place. If necessary, make more passes through the eye until both halves of the wire are wrapped into it all the way down to its base.

Now take the two halves of the wire and wrap them back together again. By rolling them between your thumb and forefinger, you should once again be able to make them resume their natural form, and the wire should look as if it had never been separated.

Use a nail or hook point to spread the lay of the standing part of the wire, and pass the re-joined ends through. Repeat this two or three times so that the end is held firmly in place and cannot come undone. Cut off the end as near as possible to the standing part of the wire. as possible. Cover up the splice by wrapping it with sticky tape or twine to protect your fingers from the sharp points of the stainless steel threads.

Instead of passing the end through the standing part to secure it, you can use a crimp or sleeve. However, because it takes longer to make than a crimped eye, the lazy splice is usually only used when sleeves are not available. Alternatively, it can be whipped down using twine or strong thread.

Or, whip or crimp the tag end down



CHAPTER 3: PREPARING TROLLING LINES

SECTION G: KNOTS FOR HOOKS AND TACKLE

Nylon monofilament fishing line is slippery and does not grip well when tied. Many knots will come undone under tension, even if they appear secure when tied. Some knots which will hold, and which can be used for attaching tackle to monofilament lines, are shown below.

Palomar knot

The Palomar knot is popular among Hawaiian fishermen, who claim it is easier to tie and less liable to slip than other knots.

To tie the Palomar knot, double the end of the line over in a loop. Pass the loop through the eye of the hook, and tie it loosely in an ordinary overhand knot. Pass the eye of the loop over the body of the hook. Pull gently on the standing part of the line and the tag end together to close the knot. Tighten it up by pulling hard on the mainline.

PALOMAR KNOT

Pass doubled-over line through eye of hook

Tie loose overhand knot

Pass loop over hook body

Pull tight

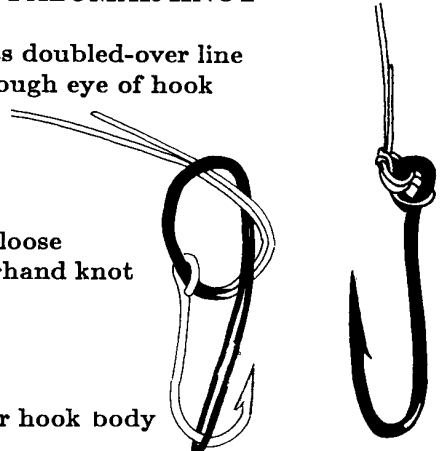

Slip knot

This knot can also be used for braided lines like super-toto, dacron, etc., whose rough surface prevents slipping and makes the clinch knot (above) hard to pull tight.

SLIP KNOT

About 25cm (1 foot)

Thread hook onto line. Leave long enough tag end to work with

Run line over end of finger and hold in place with thumb

Thread the line through the eye of the hook or swivel, leaving about a foot of line to work with. Run the line down the inside of your forefinger, around your fingertip, and up the back of the finger, leaving the hook eye pulled against the fingertip. Take four or five loose turns with the tag end around the finger, working back towards the fingertip. Pass the tag end back along the finger inside the loose turns. Remove the finger, holding the turns in place with the other hand, and pull gently on the tag end. This will tighten the knot around the main line, leaving a long loop, which can be pulled tight by holding the hook with pliers and pulling hard on the mainline.

Take 4 or 5 wraps around finger

Thread end under wraps, back towards hand

Remove finger carefully, holding turns in place with other hand

Pull tight

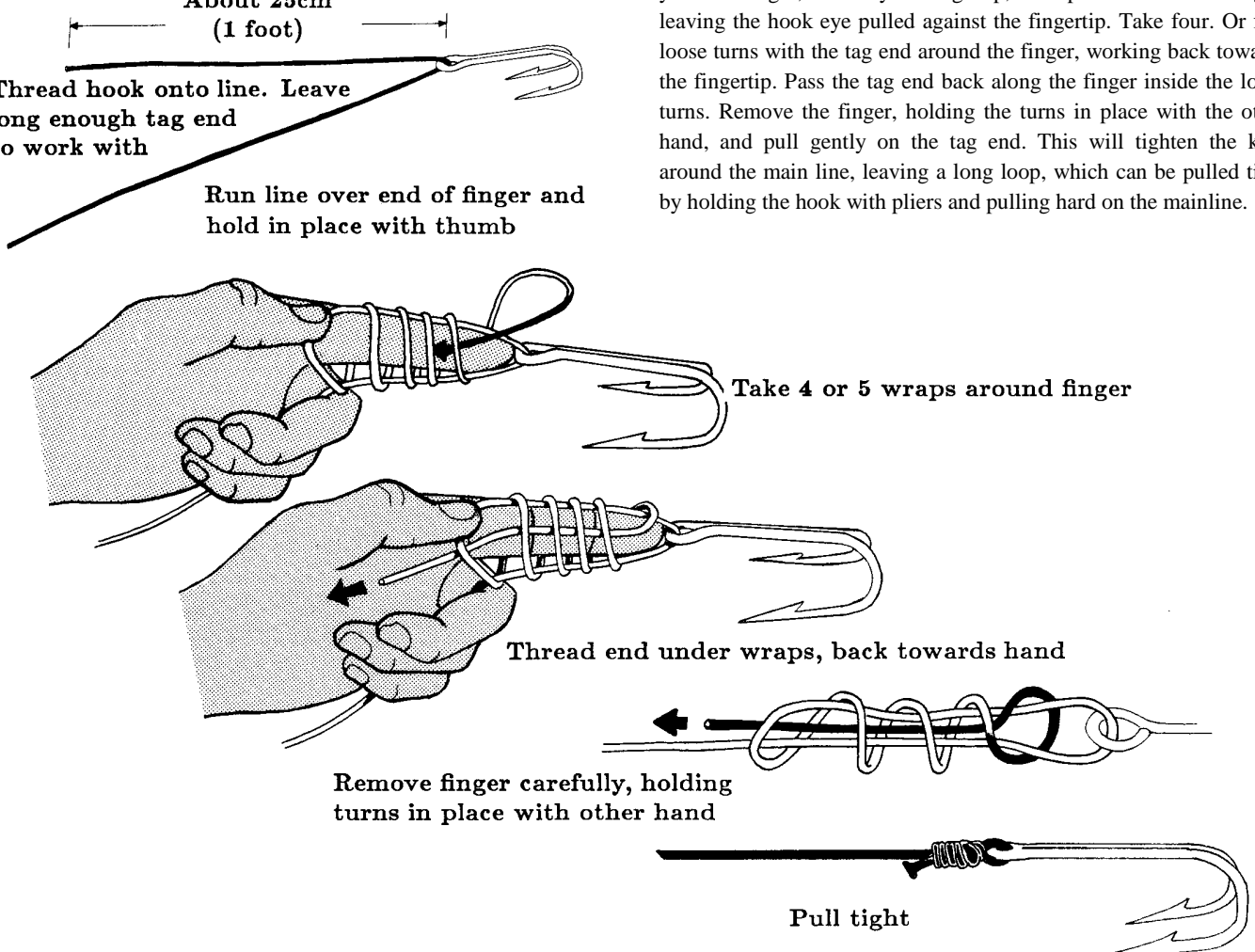

Clinch knot

Pass the end of the line through the eye of the hook and double it back. Rotate the hook four or five times, twisting the lines around each other. Lubricate the lines with saliva to make it slip more easily. Pass the tag end back through the loop at the end of the twist and pull gently so that the knot starts to close up. Pass the tag end back under itself. Hold the hook with pliers and pull hard on the mainline so that the knot pulls tight. Pull the tag end tight and cut off close to the knot, then flatten it with pliers or your teeth so that it cannot slip or be pushed back through.

CLINCH KNOT

Thread tag end through eye of swivel or hook.

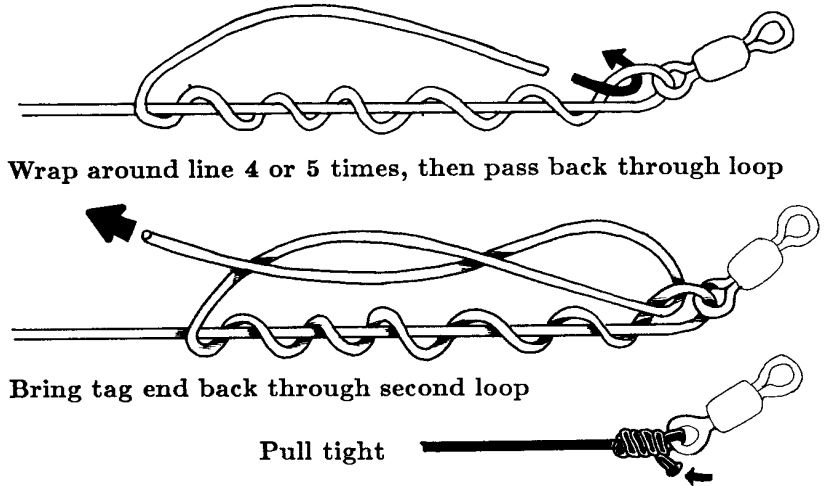

'Trilene' knot

The 'Trilene' knot is recommended by the manufacturers of a proprietary brand of nylon monofilament. It resembles the clinch knot (see above) in some ways, but to start it, the line is passed through the eye of the hook twice instead of just once. The hook is then twisted around 4 or 5 times as with the clinch knot, and the tag end passed through the double loop of line where the hook is attached prior to pulling tight.

'TRILENE' KNOT

Similar to clinch knot (above), but...

...start with double pass through eye of hook

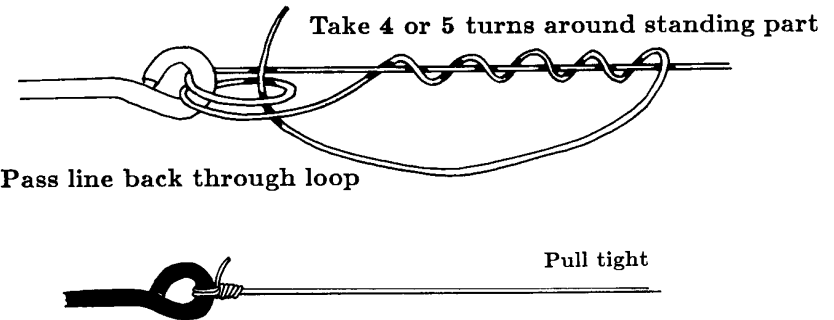

Tying a hook rigid on wire

For some types of trolling, especially when using natural baits (see sections 4B-4F) and ganged hooks rigged on wire traces, it is useful to tie the first hook rigid on the end of the line, so that it cannot hang free or swing around too much.

Pass the wire through the hook eye, wrap it tightly two or three times around the hook shaft then pass it back through the hook eye from the opposite direction. The haywire twist and final wrap are then made as for a normal end loop (see Section 3D).

TYING A HOOK RIGID ON WIRE

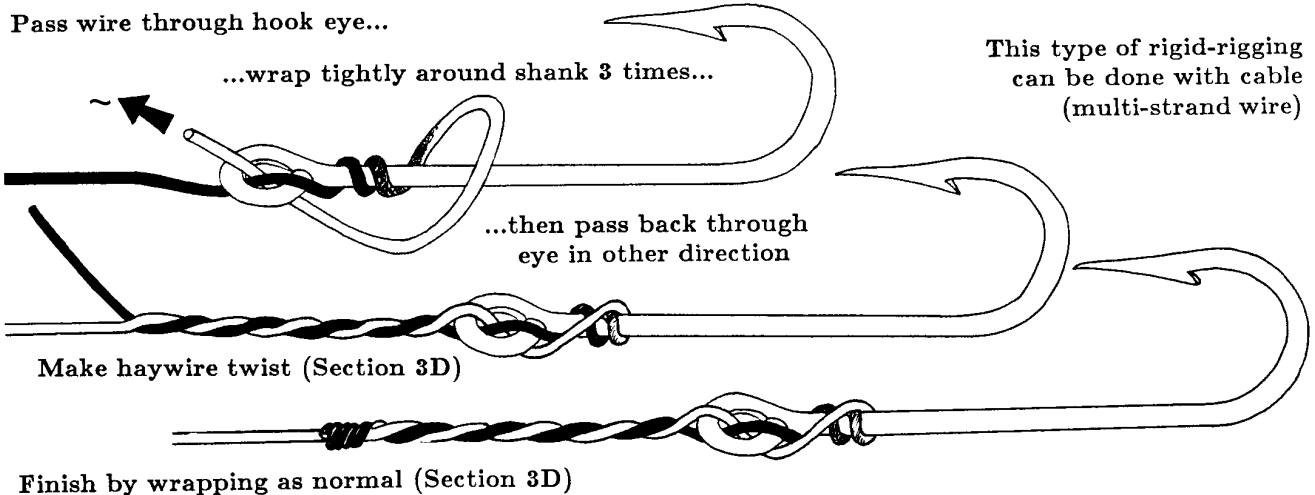

CHAPTER 3: PREPARING TROLLING LINES

SECTION H: JOINING LINES TOGETHER

Most trolling lines are a composite of several lengths of different materials, joined together in various ways along their length. Lines can be joined directly to each other when they are of the same or similar materials. If they are of very different materials, such as nylon and wire, they should be joined indirectly, using a ring or a swivel in between. This prevents one line damaging or cutting the other.

The knots below are recommended for making permanent connections in lines (not wire), repairing breaks or damage, etc.

Blood knot (also called Barrel knot)

This is suitable for joining monofilament and similar lines.

1. Twist the line ends around each other 8-10 times, leaving enough of a tag end to work with.
2. Using a finger, toe, or fixed object, spread apart the lines at the centre of the twist.
3. Pass the two tag ends between the spread-apart lines from opposite sides.
4. Tighten the knot by pulling on the main lines. Moisten the knot with saliva to help it slip.
5. Cut off the tag ends and flatten them with pliers or your teeth to prevent them slipping back through.

BLOOD KNOT (BARREL KNOT)

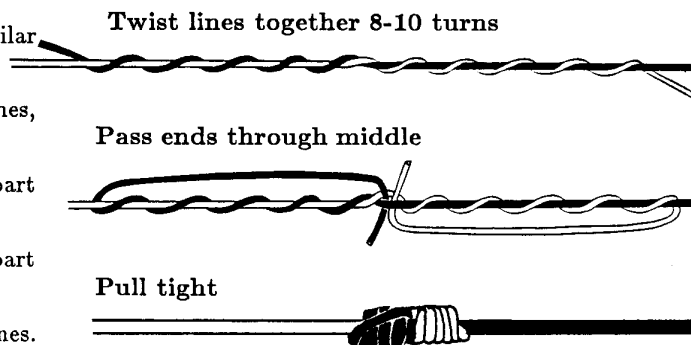

Double slip knot

Suitable for heavier lines or those which have a rough surface and do not slip easily.

1. Make a slip knot in one of the lines as shown in Section 3G. Pull the turns tight by gently drawing on the tag end while holding onto the loop. Leave the loop large enough to work with and do not pull it tight.
2. Pass the second line through the loop and make a second slip knot exactly the same as the first.
3. Tighten up the knot by pulling hard on both main lines. When tight, cut off the tag ends.

DOUBLE SLIP KNOT

Make slip knot (see Section 3G) in end of one line. Do not pull tight

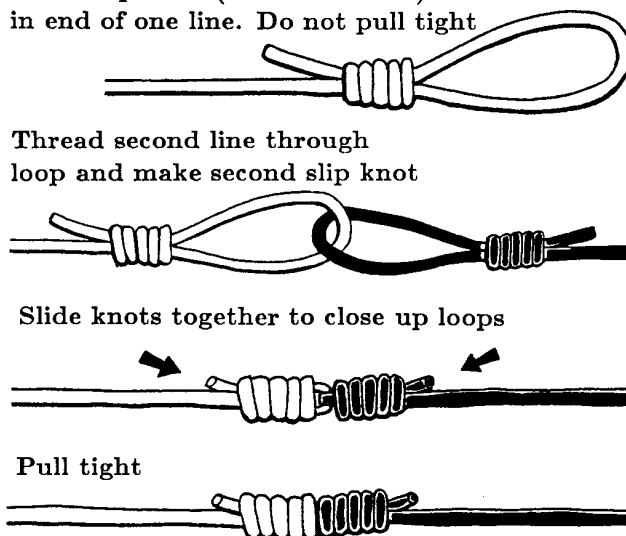

Looking at the above drawings, you can see that in the blood knot, each line wraps around the other, while with a double slip knot each line wraps around itself. This characteristic gives a lot more strength to the blood knot, especially when using thin lines which tend to cut through each other. The blood knot is recommended for use whenever possible, and always with nylon monofilament.

Using end loops

Joining lines using end loops (see Sections 3D-3F) is simple and allows easy disconnection of traces, etc. An end loop is made on each line to be joined. One line is passed through the end loop on the other as shown, and the two lines pulled up tight.

Don't use end loops (or knots) to join hard materials (such as wire) to soft ones (such as monofilament). Use a swivel or connector as shown opposite.

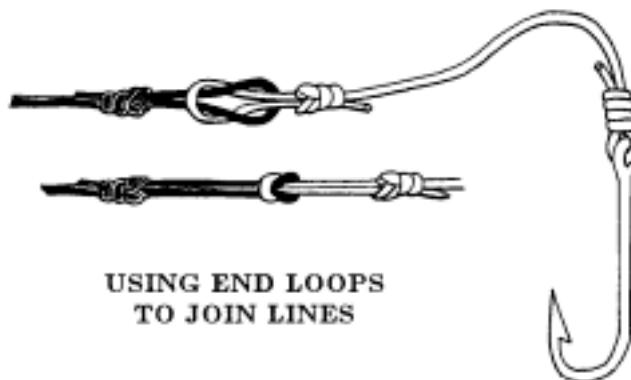

Connector rings and swivels

These are used when the lines to be joined are of different types and there is a danger that one will cut or wear through the other one. Rings are very simple and can be improvised from heavy galvanized fence wire or similar materials. Swivels must be shop-bought but are much better than rings as they prevent the action of a spinning lure or bait from twisting up the entire length of the line.

Some swivels have snaps, clips or other 'easy fix' devices which allow rapid changing of lures and traces, attachment of sinkers, etc., while fishing. However, beware of lightweight snaps and clips which are often much weaker than the rest of the swivel, and will break or open at the impact of a striking fish.

SWIVEL TYPES

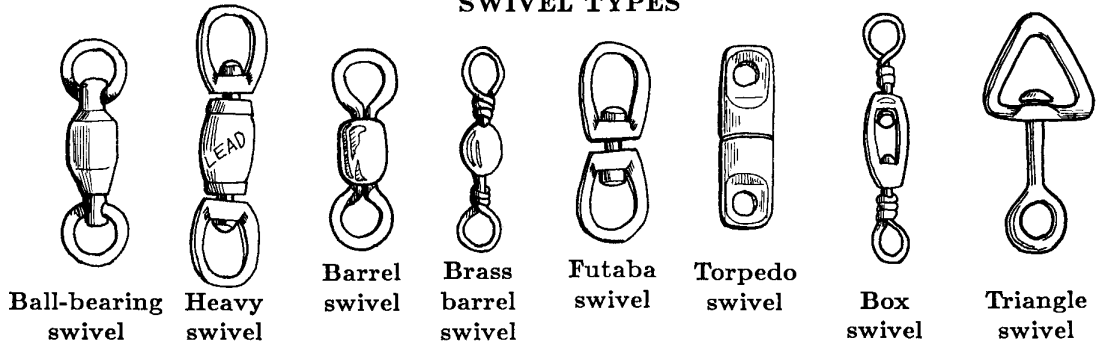

SWIVELS WITH CLIPS AND RINGS

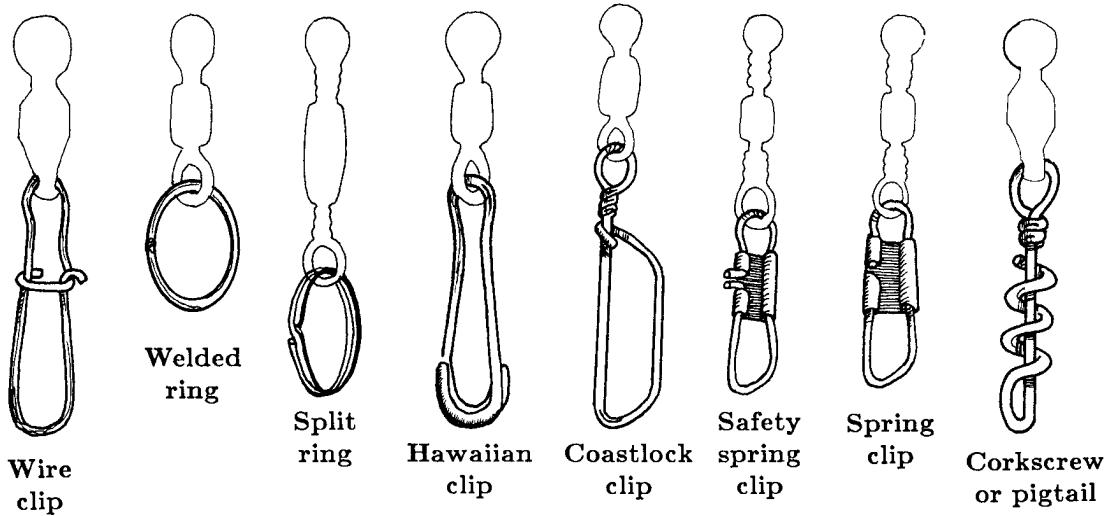

RINGS AND CONNECTORS

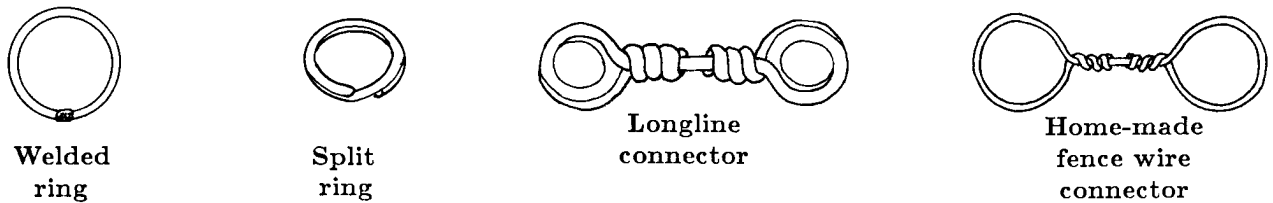

Swivels can be easily attached using end loops, or the knots shown in Section 3G. It is better to make permanent connections using knots, etc., whenever possible. Only use end loops or snap swivels when it will often be necessary to disconnect and re-connect lines (e.g., changing traces, etc.).

Use swivels whenever possible when joining lines



Use clips or fasteners if the lines will be often taken apart

CHAPTER 3: PREPARING TROLLING LINES

SECTION I: THE ASSEMBLED TROLLING LINE

The completed trolling line is a composite line normally made up of three distinct parts -the trace, to which the bait is attached; the mainline, used to distance the bait and trace from the boat; and the backing, which performs different functions depending on the trolling arrangement.

THE ASSEMBLED TROLLING LINE

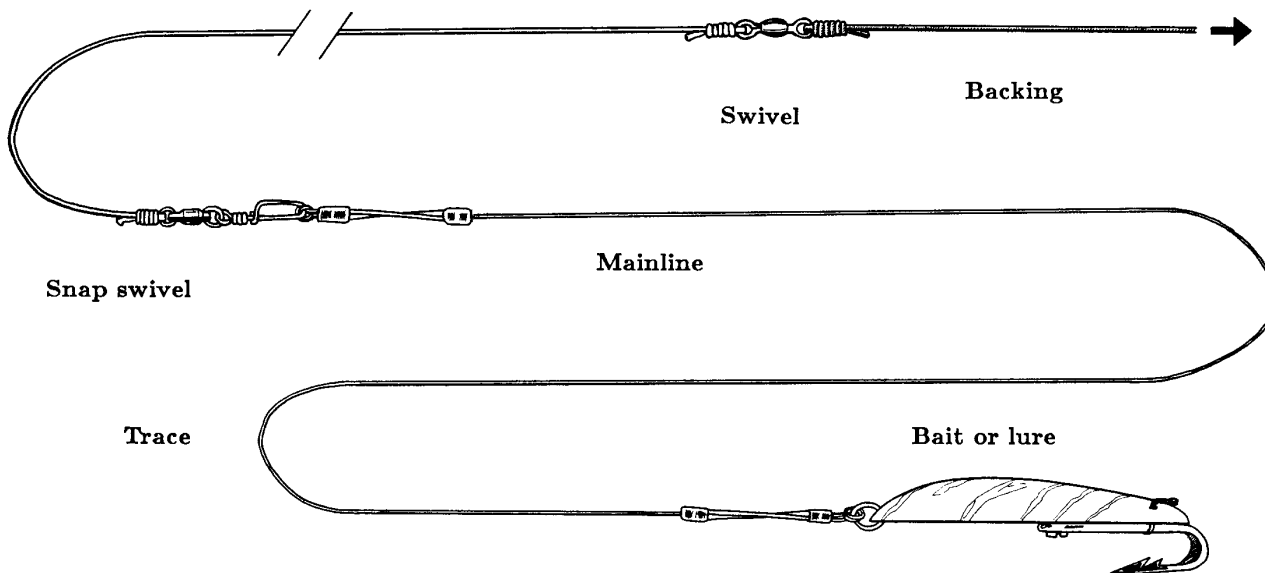

The mainline

This makes up most of the length of the line. It should be strong but light, and durable enough not to need replacing too frequently. Nylon monofilament of 100 kg to 300 kg breaking strain is normally used, but other types of line such as braid line or, for subsurface trolling, cable can also be used. Line length depends on the type of trolling being carried out -30-50m would be typical, but see Section 3B for more detailed comments on line types.

The trace

The main function of the trace is to take any damage caused by striking fish and so protect the mainline at its own expense. Therefore, the trace is usually of lower breaking strain than the mainline. The trace must also resist the fish when it attacks the lure, and in its subsequent fight to escape. As many of the tropical species caught by trolling have razor-sharp teeth, it is usual to use wire or cable for traces. The exception is when trolling for oceanic tunas, whose small teeth permit them to be taken on monofilament traces.

A desirable property of a trace is invisibility. The more easily the fish can see the trace, the less likely it is to attack the bait. This is particularly true of tunas, which have excellent eyesight and which will often only strike lures rigged on nylon monofilament.

A trace is thus a compromise between strength, resistance to cutting, and visibility. The material chosen must resist the teeth and the impact of the fish being caught, and should be as invisible as possible. If used on a fixed line (see Section 31) it should have a lower breaking strain than the mainline, but this is not necessary if used on a reel equipped with a drag (see Sections 3M and 3N).

TRACE MATERIALS

The easier a fish can see the line...

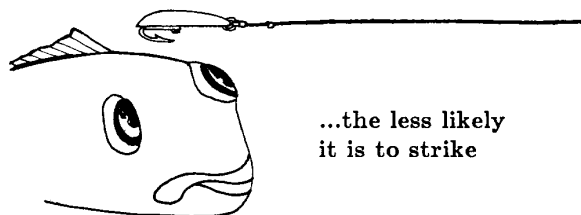

...the less likely it is to strike

For soft-mouthed fish (like tuna)...



...use monofilament

For sharp-toothed fish (like many reef species)...

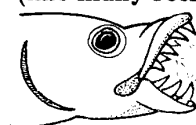

...use wire or cable

Changing traces

It is usual to attach traces to the mainline in a way that enables them to be disconnected and rapidly replaced when damaged or when baits are being changed. When possible use a good-quality snap swivel at this point to prevent any twists caused by the spinning of the bait being passed up the mainline.

Trace length

Trace length depends on the material and its ease of handling and storage. The trace should be long enough to ensure that no part of the fish will come into contact with the mainline, even when it is swimming directly away from you.

If the trace is less visible than the mainline, it should be long. If it is of some highly visible material (cable) it should be as short as possible. Much depends on personal preference, but as a rough rule, allow 1-2m (3-7 feet) for cable, 2-5m (7-17 feet) for wire, and up to 10m (33 feet) for nylon.

CHANGING TRACES

Using a strong snap swivel on the end of the mainline...

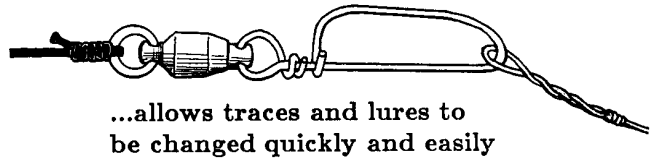

TRACE LENGTH

Trace should be long enough...

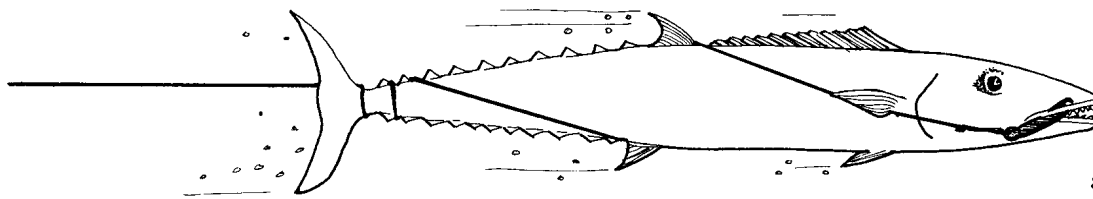

...to prevent fish from damaging mainline under any circumstances

If using heavy cable, keep traces fairly short



For light cable or wire, traces can be longer



For light wire or monofilament, use longest traces to take advantage of low visibility

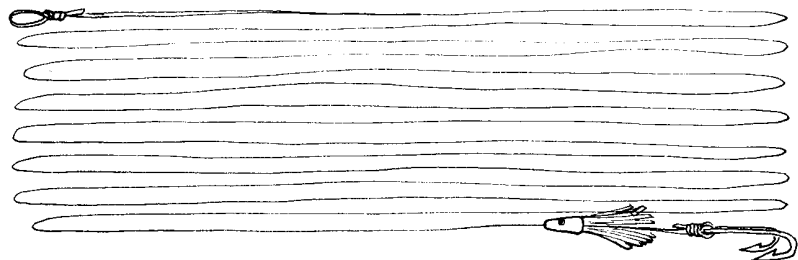

The backing

This is usually a heavier, and often cheaper, material than the mainline and does not normally go in the water. Its function varies: on a fixed line (Section 31) it incorporates a shock absorber; and on a handreel (Section 3M) it can serve to protect the mainline and act as an emergency backup line when the fish is too strong to control. More information on backing can be found under these two sections.

CHAPTER 3: PREPARING TROLLING LINES

SECTION J: SINKERS

Most of the materials normally used to make up a trolling line - nylon monofilament, wire, cable, hooks, and the bait itself - are denser than water and would normally sink. However, when trolling, the pressure of water against the line forces it to the surface, particularly when trolling at high speed. Most baits and many types of lures normally 'swim' at or just below the sea surface, and may even leap or skip out of the water if trolled too fast.

Nevertheless, it is often desirable that the bait should be presented deeper in the water to be attractive to some types of fish (see Section 51). There are various ways of forcing the bait or lure to swim deeper.

Heavier line materials

Using wire instead of nylon monofilament for the mainline will lower the bait by an amount which depends on the line length and speed. However, cable is usually a costly material for a mainline, may rust or corrode and need frequent replacing, and may be difficult to handle or prone to kinking.

Sinkers

A variety of heavy materials can be used as sinkers. As well as lead weights manufactured for the purpose, lengths of iron bar, chain, etc. can also be used. If using steel bar, weld or lash eyes firmly onto each end, or tie onto a short length of cable.

An ideal trolling sinker consists of a series of cast lead barrel weights threaded onto a short length of heavy cable. An eye should be made at both ends, with a snap swivel attached to one of the eyes, so that the sinker can be attached to the trolling line between the mainline and the trace, and easily removed when necessary. Heavy grade cable, preferably stainless steel, should always be used as the lead weights will accelerate its corrosion.

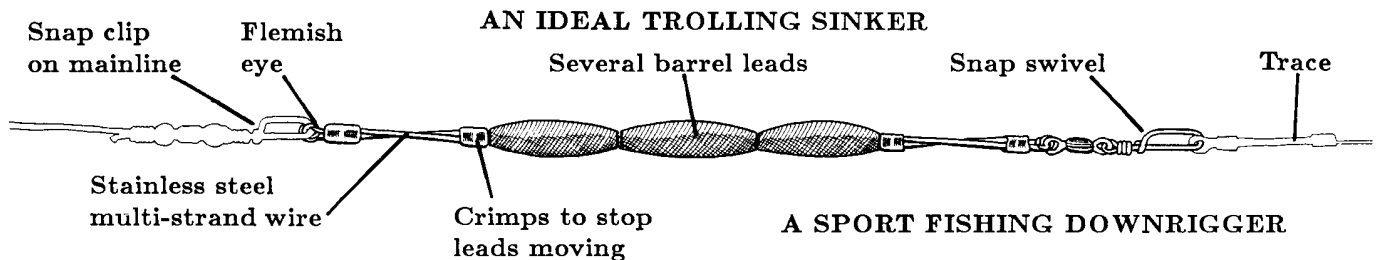

Downriggers

Downriggers are heavy weights, normally 1kg (2lb) or more, and usually equipped with fins or vanes to prevent them from spinning. Several different attachment points on the fins also allow some adjustment of the angle at which the downrigger will 'swim', both horizontally and vertically.

A downrigger is not fixed directly into the trolling line. Instead, it is towed from a separate line tied to a point on the back of the boat (or, for very heavy weights, suspended from a deck winch). The fishing line is attached to the downrigger by a weak link, or 'breakaway', which will part when a fish strikes, freeing the line. The fish and the weight are then hauled in separately.

Downriggers are mainly used in sport fishing but have also found favour with some commercial fishermen.

SINKER TYPES

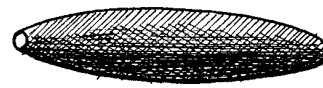

Barrel lead

Old chain

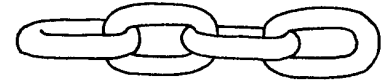

Steel rod with eyes...



...welded on...



...or lashed on

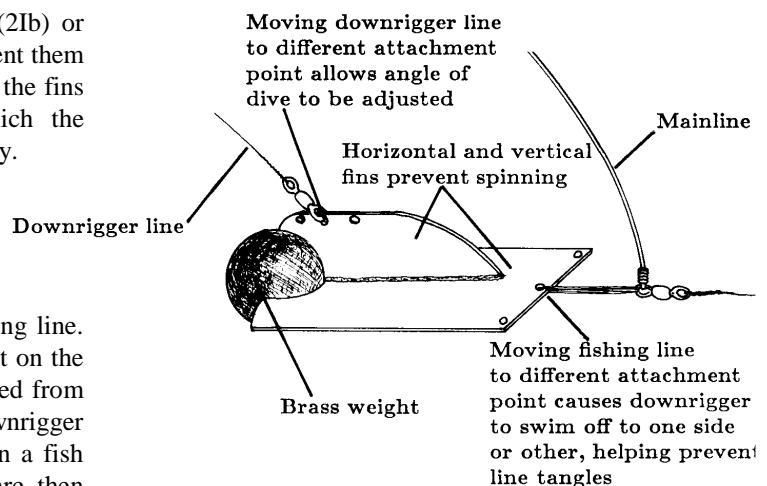

Cannonballs

'Cannonball' or large downrigger trolling is a technique used by commercial salmon fishermen in the northern hemisphere, and by some game fishermen in the Pacific. This method uses a heavy weight of between 1 and 25kg (2 to 55lbs) trolled at slow speeds (less than 2 knots) to get one or more lures down very deep. Home-made 'cannonballs' of various designs can also be improvised.

This technique is of possible application in commercial trolling for deep-swimming tunas, especially around FADs, and is currently under trial in SPC experimental fishing programmes. However, its suitability for smallscale commercial fishermen in the Pacific Islands region has not so far been fully demonstrated and the technique is not discussed further in this book, as it requires specialised heavy-duty trolling tackle and deck gear.

A CANNONBALL TROLLING RIG

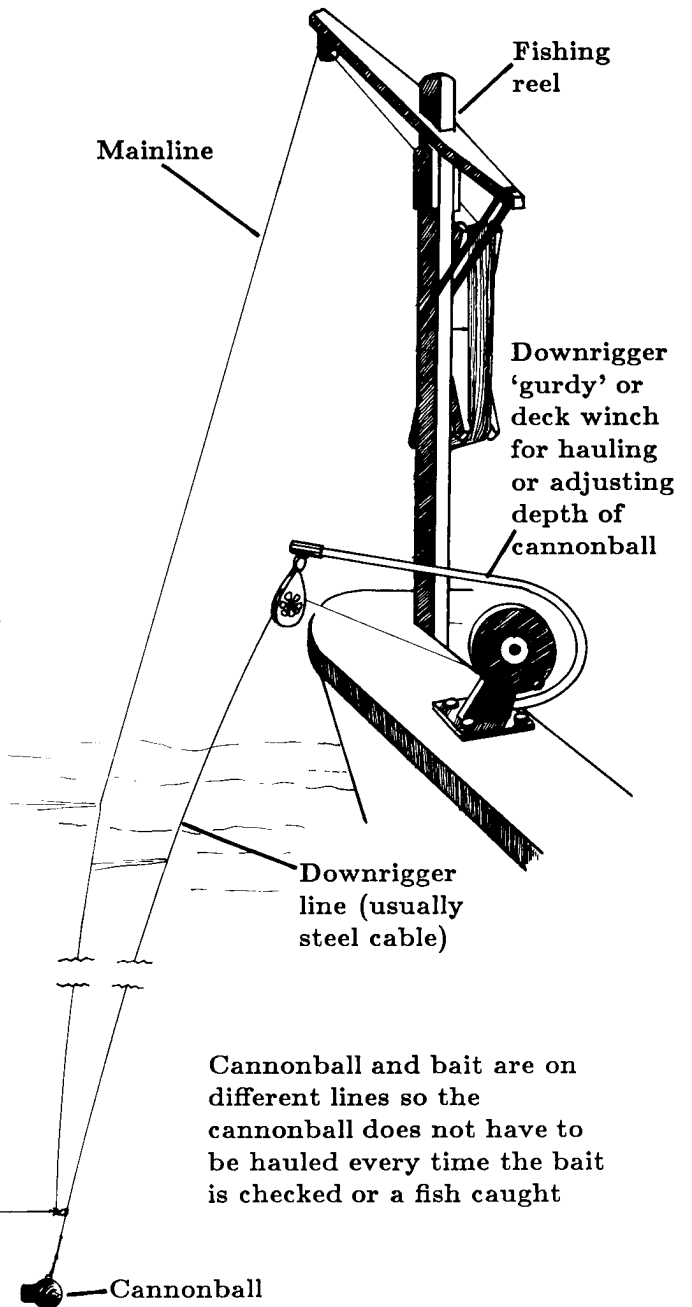

CANNONBALL DETAIL

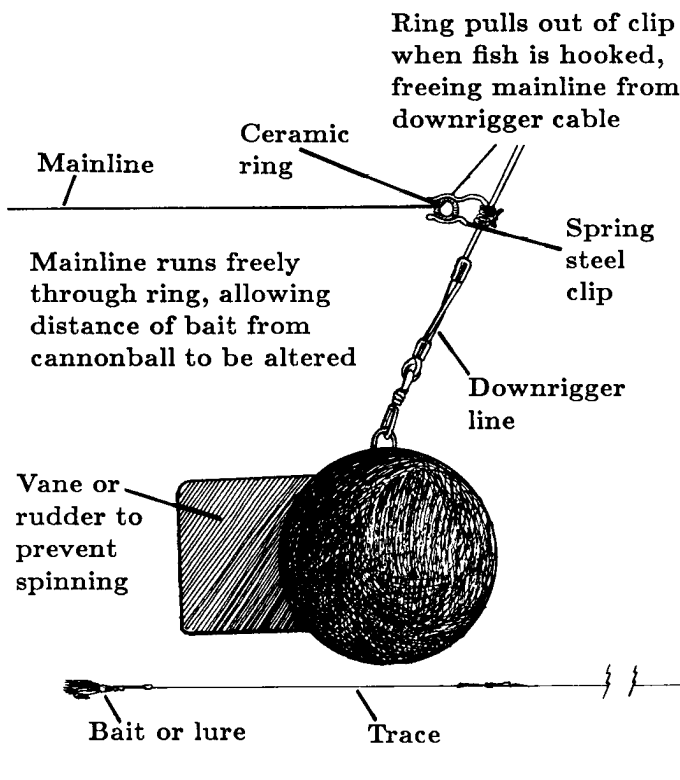

A HOME-MADE 'CANNONBALL'

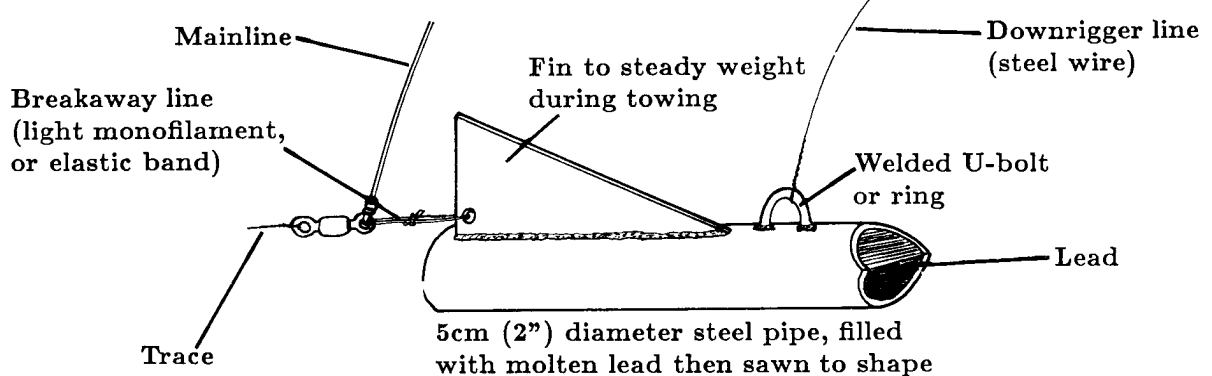

CHAPTER 3: PREPARING TROLLING LINES

SECTION K: DIVING DEVICES

Diving boards and similar devices are used as an alternative to sinkers to get the line down deeper. A diving device planes like an underwater kite, diving deeper and carrying the lure along with it.

Diving boards

These are small wooden, plastic or metal boards or plates, often with a weighted nose, which are attached between the mainline and the trace. Under normal trolling conditions they will dive down, taking the bait behind them.

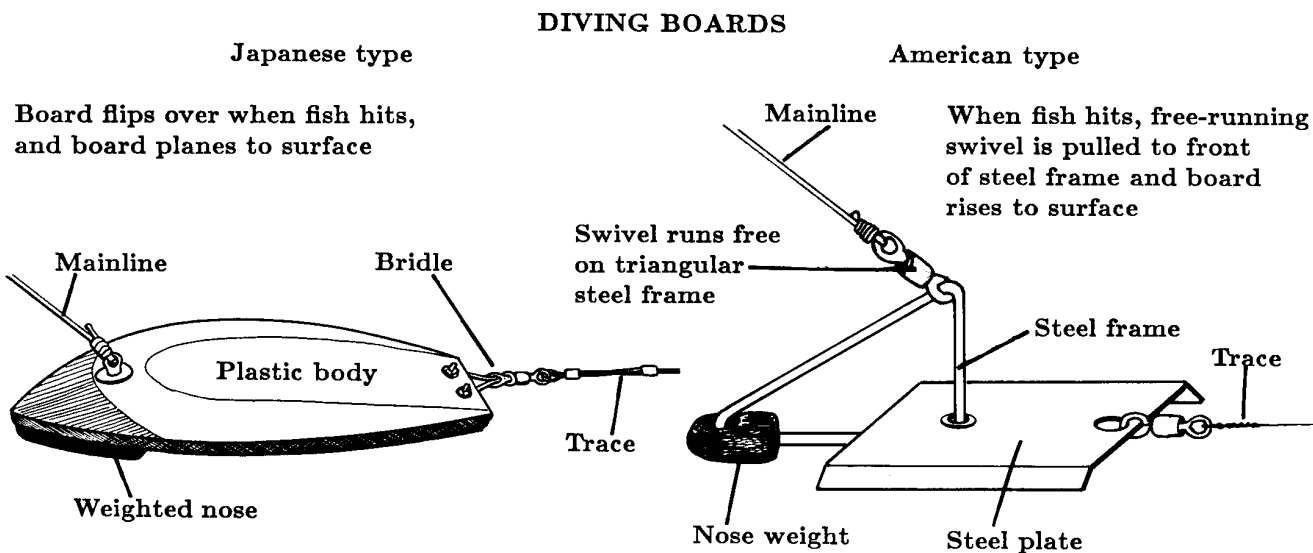

Tripping

The trolling depth of the board depends on the amount of line you payout. Once the board reaches its maximum depth, it will (usually) stay there and remain steady provided that it is properly balanced. When a fish hooks up on the lure, the added weight on the line alters the board's angle and causes it to rise to the surface, dragging the fish along with it.

ACTION OF DIVING BOARD

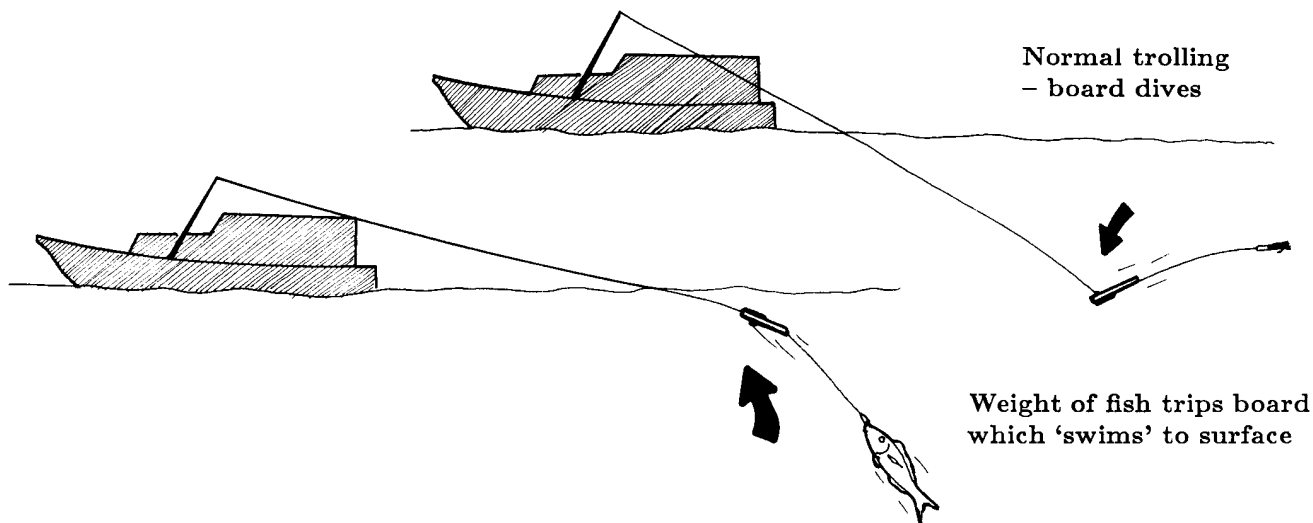

Although the most effective way to get a bait or lure down deep, a line with a diving board will often lose more fish than a weighted line, because it tends to go slack when the fish strikes and the board becomes unstable. A badly balanced board will swim from side to side and may spin when surfacing, causing line tangles.

Diving lures

Some artificial lures are themselves designed to dive. These usually incorporate a 'mini-diving board' or bib at the front of the lure, or have an angled nose or head section which forces them down. Lures of this type will usually dart from side to side very actively when being trolled. See Section 4A for more information on lure types.

DIVING LURES

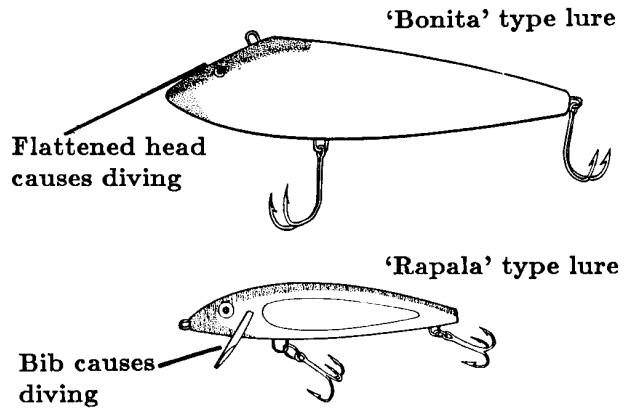

Trolling depth

At the same trolling speed, the sinker and diving board types described in this section and in Section 3J would achieve the relative depths shown in the drawing below.

HOW DEEP WILL THEY GO?

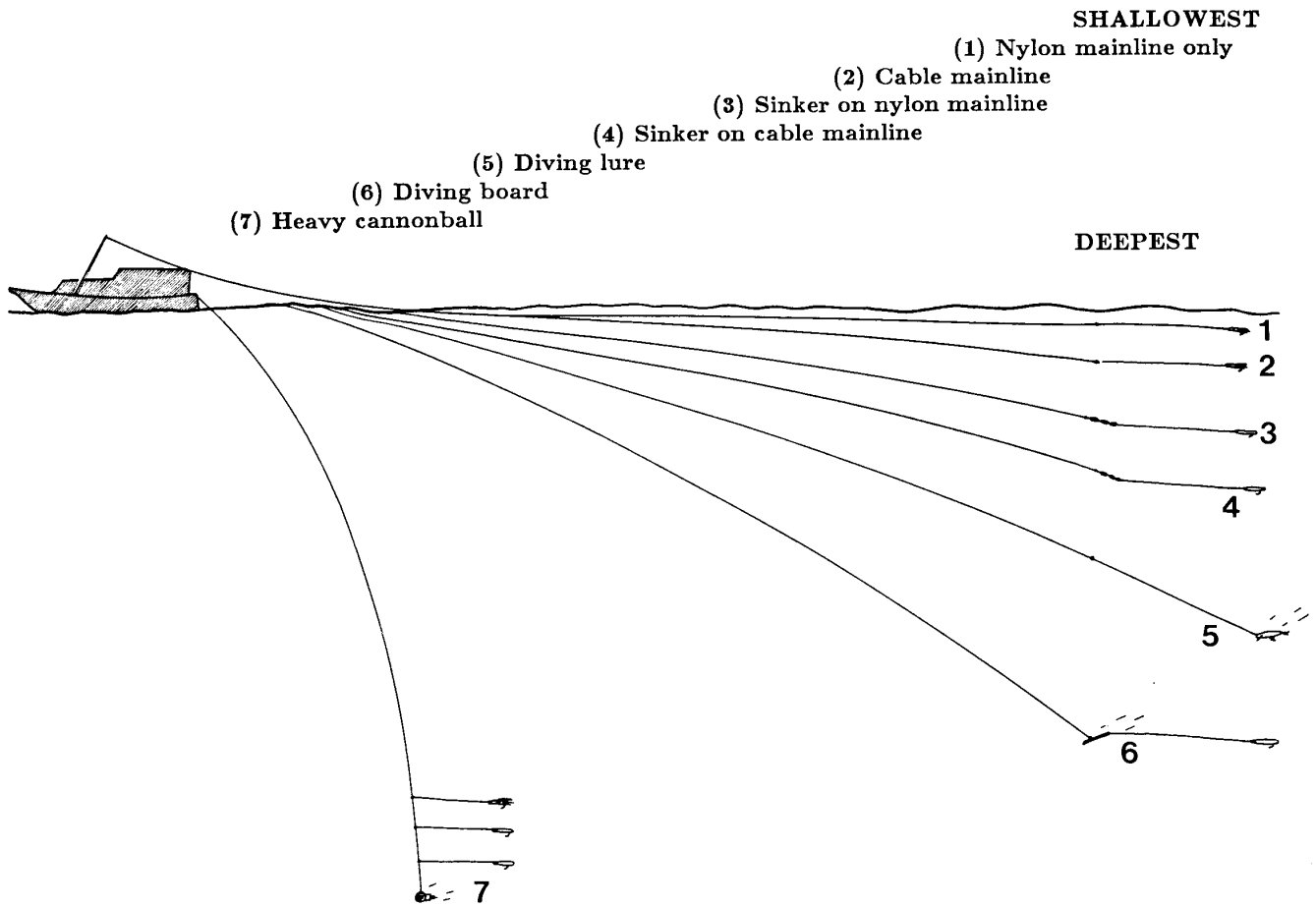

This is a guide only, and will vary depending on line length, sinker weight, lure type, etc

CHAPTER 3: PREPARING TROLLING LINES

SECTION L: RIGGING FIXED LINES

A fixed trolling line is attached by the backing cord to some point on the boat, such as the transom or trolling boom. The mainline is tied or clipped to the end of the backing cord, preferably with a swivel in between. When a fish is hooked, it is hauled in hand over hand.

Making shock absorbers

When rigging a fixed trolling line it is very important to incorporate a rubber shock absorber into the backing cord. This takes the impact of the initial strike of the fish, reducing the chances of line breakage. It also sets the hook in the fish's mouth. Without the shock absorber, the hook can be snatched or torn out of the fish's mouth when it strikes, so more fish will be lost.

The best shock absorbers are those which are manufactured for the purpose, but home-made versions can be almost as good. Old bicycle inner tubes doubled over, loops or strips cut from car inner tubes and lashed together, or lengths of light rubber tubing are all commonly used. Length depends on the strength and stretchiness of the rubber - 25-75cm (20-30 inches) is normal.

Rigging shock absorbers

The shock absorber should be tied into the backing cord as shown below, using bowline knots or eye splices (see Section 3E) to make the end loops. Since rubber is much weaker than rope, it is essential to incorporate a safety rope to prevent the loss of the entire line if the rubber breaks. Tie the safety rope to the loops in the backing cord (not to the shock absorber) and make sure it is long enough to allow the rubber to stretch fully.

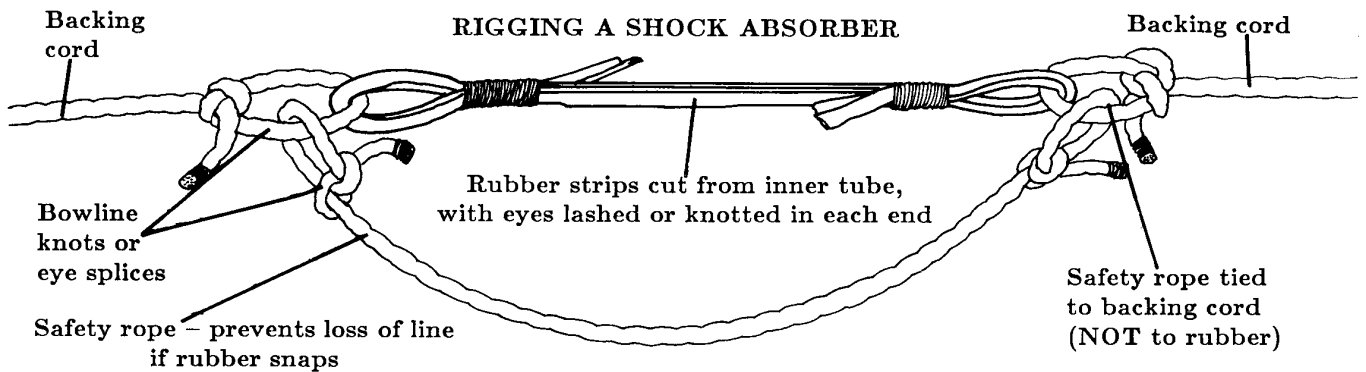

Position

The shock absorber should be very close to the point where the backing cord is attached to the boat. This will prevent it hanging down and forming a belly in the line. If it does this, the slack line will increase the chances of fish not being properly hooked on the strike.

POSITION OF SHOCK ABSORBER

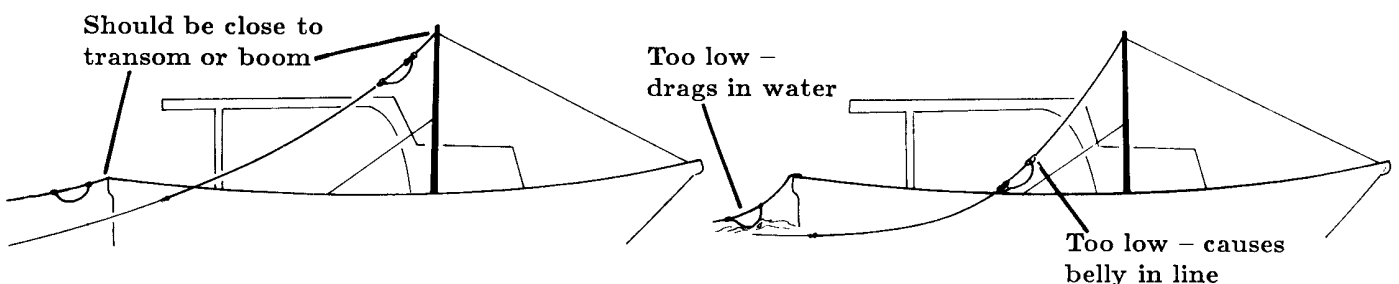

SHOCK ABSORBER MATERIALS

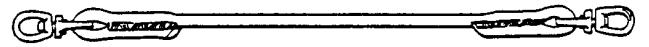

Commercial type with swivels

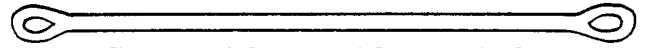

Commercial type without swivels



Old bicycle inner tube

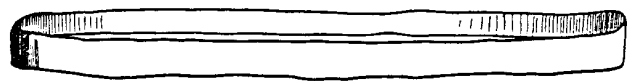

Strips or loops cut from large inner tubes

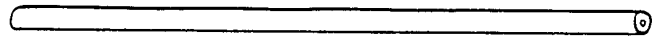

Surgical rubber tubing or speargun rubber

Backing cord and lazy line

The backing cord is usually left permanently attached to the boat or trolling boom. Its purpose is to carry the shock absorber, and to act as a 'lazy line', or attachment point, for the mainline, which is tied or clipped onto it. This is very important on a trolling boom, as otherwise it would be necessary to bring the booms inboard every time a line had to be attached or disconnected.

A good system is to make the backing cord and lazy line from the same continuous length of rope. A figure-of-eight knot (see Section 3D) is tied partway along the rope, and serves as the attachment point for the mainline. The part of the line between the boom and the loop is called the backing cord: the part between the loop and the boat is the lazy line.

The position of the attachment loop (the figure-of-eight knot) should be worked out carefully before tying. The lazy line should be long enough to hang loosely between the boat and the trolling line during normal fishing, preferably without dangling in the water. The end should be tied to a fixed point on the boat when fishing starts and not disconnected until fishing is over. When the lazy line is pulled in, the attachment loop should swing into the boat at exactly the spot from where the mainline would normally be hauled. In this way, the start of the mainline is delivered straight into the fisherman's hands, and hauling is rapid and efficient.

If available, a heavy duty swivel should be placed in the attachment loop before it is tied. The mainline can then be clipped onto the swivel instead of directly to the attachment loop, and is less likely to twist.

The backing cord should be kept as short as possible, while still allowing it to do its job. For a line attached to the stern of the boat, it can be as short as one metre (3 -4 feet). For a line attached to a trolling boom, it may be several metres long, depending on the size of the boat and the length of the boom.

BACKING CORD / LAZY LINE

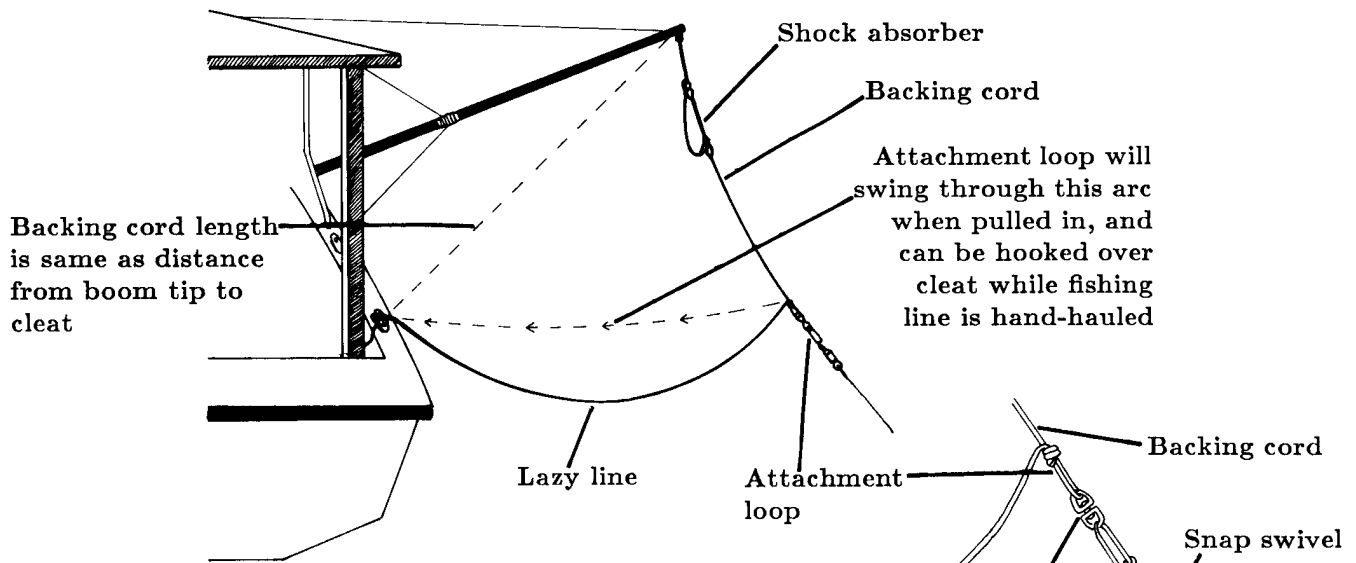

STORING FIXED LINES

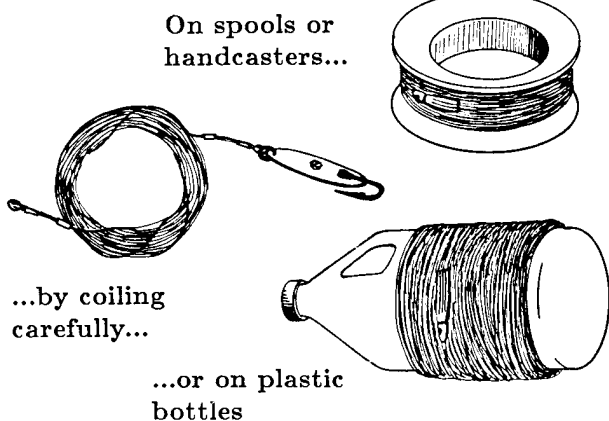

Line storage

Fixed lines can be stored on a plastic handcaster, an old bottle, or similar item. At the end of fishing, haul the line as normal, wrapping it onto the handcaster as you go. Do not detach the mainline from the backing cord until it is all on board the boat. Leave the backing cord attached to the trolling booms or store it separately.

More information on fishing with fixed lines is given in Section 6D.

CHAPTER 3: PREPARING TROLLING LINES

SECTION M: RIGGING LINES ON HANDREELS

When trolling, wooden handreels, (see Section 2F) have a number of advantages over fixed lines. They allow easy adjustment of line length, help avoid the snagging and tangling which occurs when lines are piled on deck, speed up line recovery, and allow big fish to be played. Perhaps most important, they also enable the line to be used for other fishing methods, such as deep-bottom fishing. Nevertheless, many people still prefer fixed lines to handreels.

Sections 2F and 2G describe the types of reels available and their mounting on the boat. This and the following sections show proper rigging of the reels for trolling.

Loading the reel

This is normally done by two people, one slowly winding the reel handle while the other holds the coil of line and ensures that it unravels freely.

Some fishermen start with 20 or 30 turns (one turn is about 1m (3 feet 4 inches)) of a light rope or cord backing, which acts to protect the mainline from damage by sharp edges on the reel, or wrap the reel once or twice with strips of inner tube rubber, for the same reason. Others see no need for any backing, and wind the mainline straight onto the reel.

For trolling, the mainline length should be at least 100 metres (330 feet), and preferably longer, (this is essential if the reel is also to be used for deep-bottom fishing).

Once winding the mainline is complete, a strong snap swivel is tied on (see Section 3H), and this serves as the attachment point for the trace during fishing.

LOADING LINE ONTO A WOODEN HANDREEL

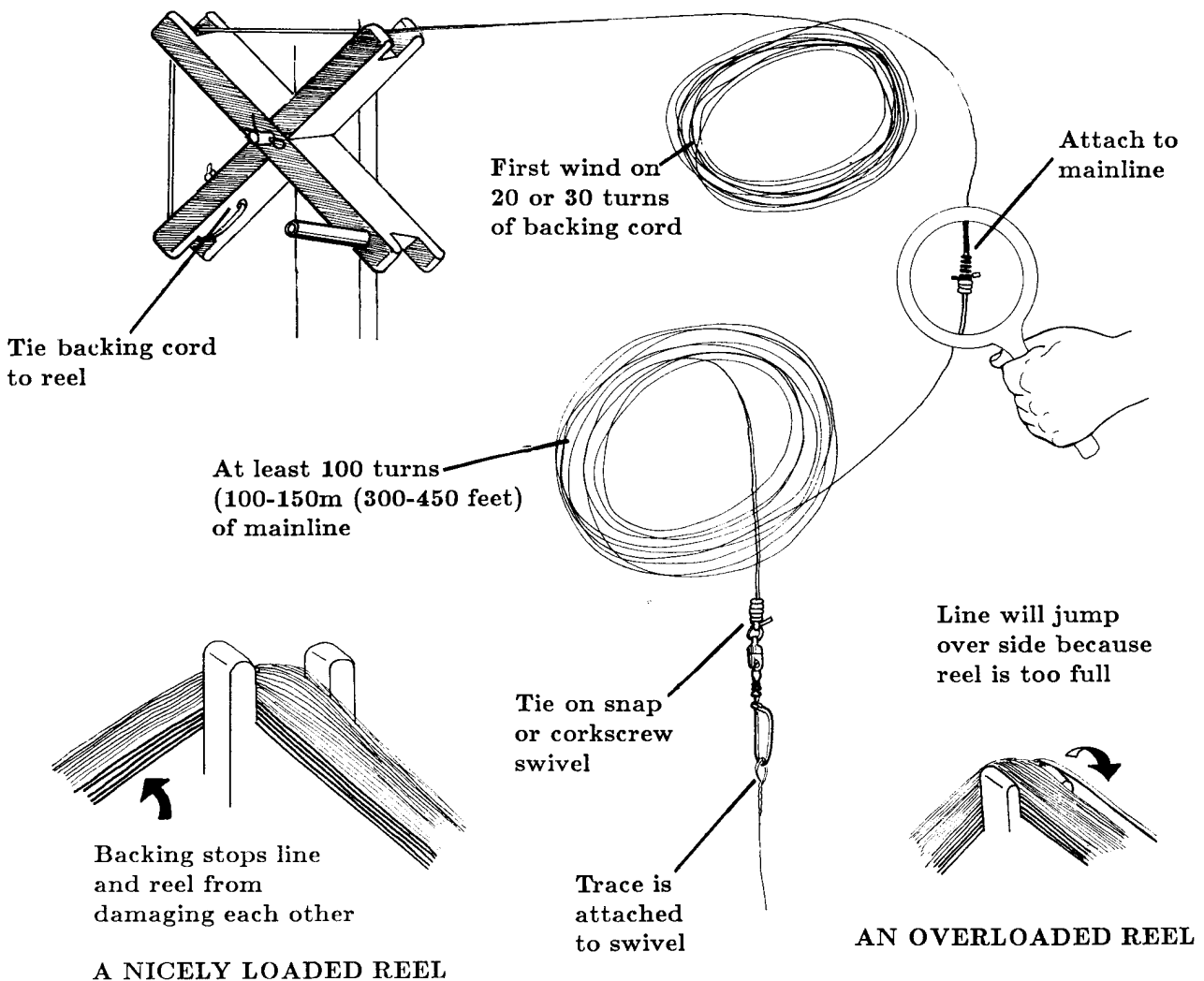

CHAPTER 3: PREPARING TROLLING LINES

SECTION M: RIGGING LINES ON HANDREELS

When trolling, wooden handreels, (see Section 2F) have a number of advantages over fixed lines. They allow easy adjustment of line length, help avoid the snagging and tangling which occurs when lines are piled on deck, speed up line recovery, and allow big fish to be played. Perhaps most important, they also enable the line to be used for other fishing methods, such as deep-bottom fishing. Nevertheless, many people still prefer fixed lines to handreels.

Sections 2F and 2G describe the types of reels available and their mounting on the boat. This and the following sections show proper rigging of the reels for trolling.

Loading the reel

This is normally done by two people, one slowly winding the reel handle while the other holds the coil of line and ensures that it unravels freely.

Some fishermen start with 20 or 30 turns (one turn is about 1m (3 feet 4 inches)) of a light rope or cord backing, which acts to protect the mainline from damage by sharp edges on the reel, or wrap the reel once or twice with strips of inner tube rubber, for the same reason. Others see no need for any backing, and wind the mainline straight onto the reel.

For trolling, the mainline length should be at least 100 metres (330 feet), and preferably longer, (this is essential if the reel is also to be used for deep-bottom fishing).

Once winding the mainline is complete, a strong snap swivel is tied on (see Section 3H), and this serves as the attachment point for the trace during fishing.

LOADING LINE ONTO A WOODEN HANDREEL

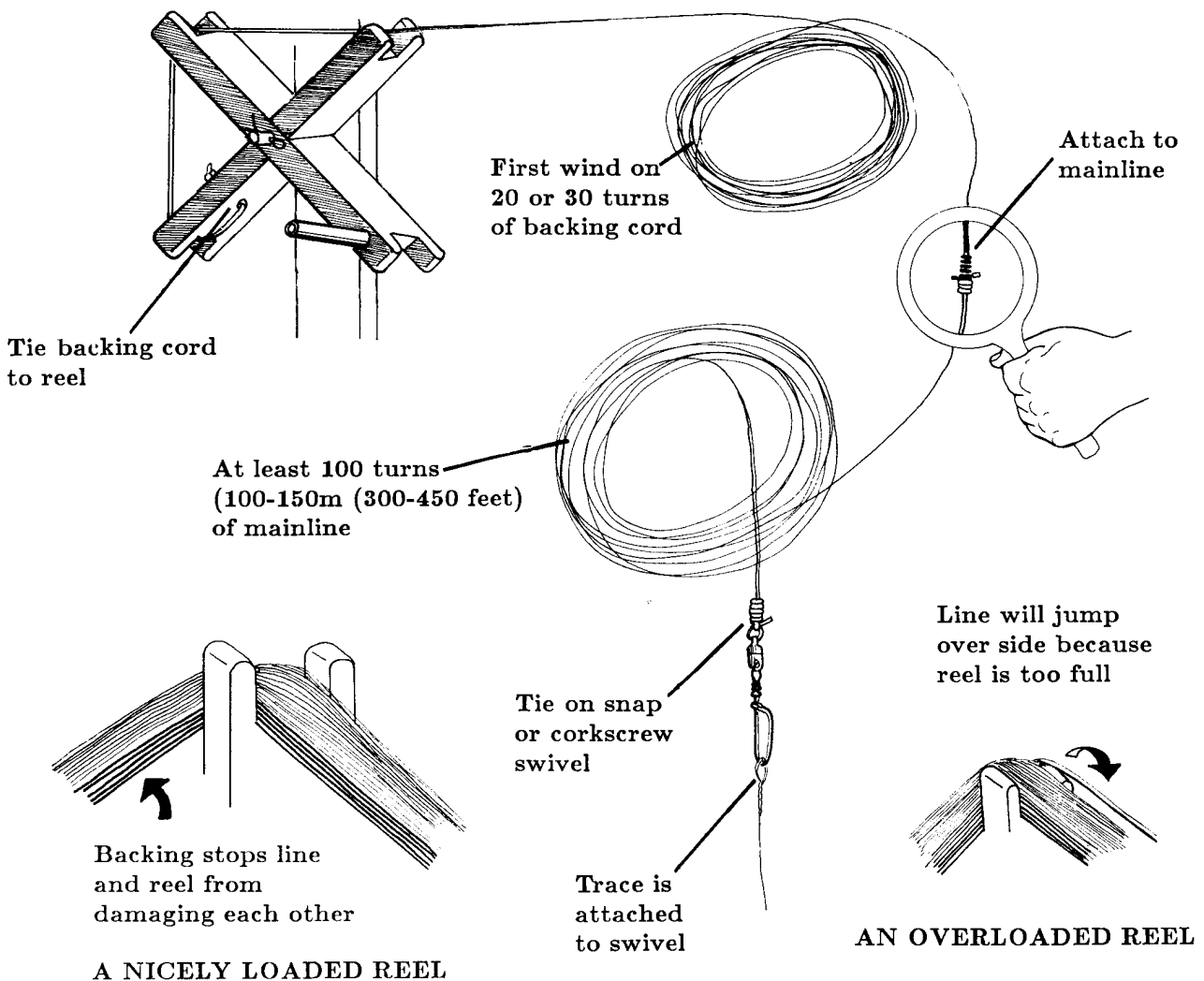

Overloading

When loading the reel, take care not to overfill it, as this can cause line to spillover the sides. Ensure that the line is evenly wound and not all on one side.

ADJUSTING THE REEL

Try turning the insulator...

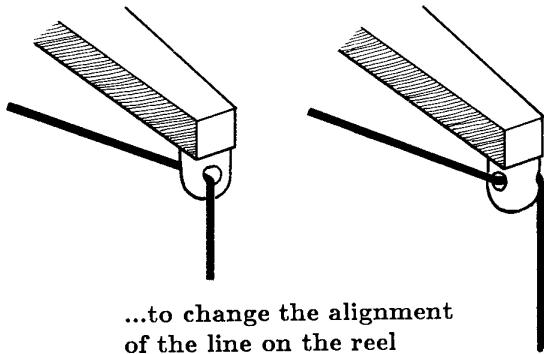

...to change the alignment of the line on the reel

Winding can be adjusted...

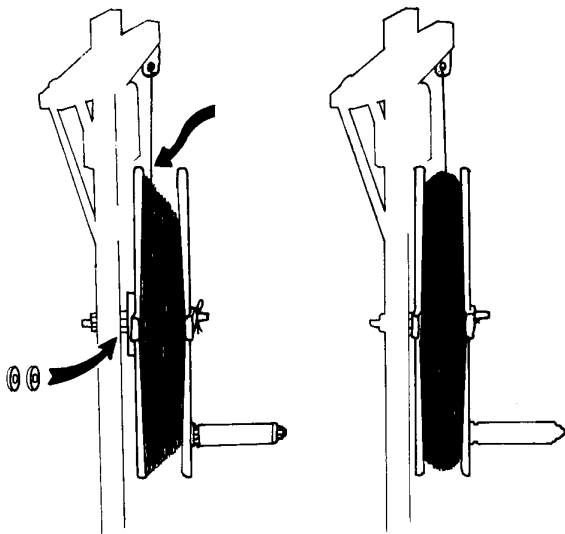

...by adding or removing spacing washers on the reel shaft

Using wire

The standard electrical insulator at the end of the reel arm is fine for use with nylon monofilament and most types of line. However, no wire of any kind should ever be wound through an insulator or other similar fitting, as the wire will immediately kink or curl and become useless. If using wire mainlines or traces which you want to wind onto the handreel, you must replace the insulator with a pulley or block, preferably 7 cm (3 inches) or more in diameter.

OVERLOADING AND MISALIGNMENT

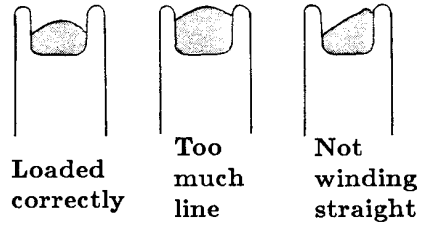

Adjustments

If the reel is not winding evenly, it may be possible to adjust this by twisting the insulator on the end of the reel arm. When winding in a heavy fish, it may also be necessary to lean on the end of the reel arm to keep the line in alignment with the reel.

Further adjustment is possible by removing the reel from the shaft and adding or removing spacing washers to alter the distance between the reel and the stanchion post.

Neither of these adjustments will make very much difference if the reel is badly made in the first place. It is very important that the reel be square and sits straight on the shaft.

USING CABLE MAINLINES

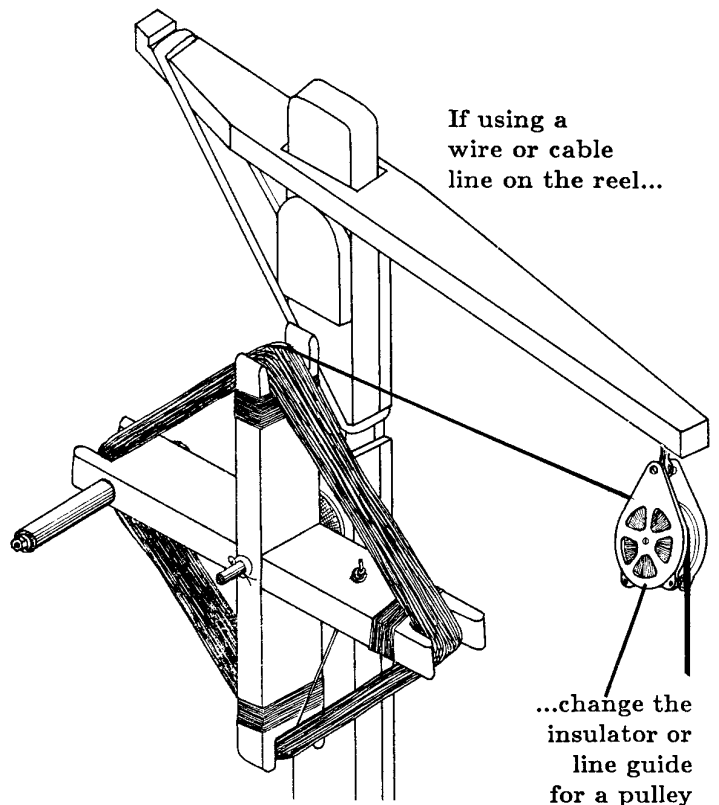

Section 3N shows how to rig the handreel for trolling. Section 6E gives information on trolling practices using the handreel.

CHAPTER 3: PREPARING TROLLING LINES

SECTION N: RIGGING HAND REELS FOR TROLLING

As with fixed lines, handreels can be used with trolling booms to increase the spread of the lines and the number that can be trolled from the boat.

Rigging through a trolling boom

Trolling booms that are to be used for handreels must have a line guide (insulator, shackle or similar) at the tip, as shown in section 2D. This should be smooth and rounded so as not to cause too much wear on the line. If a wire mainline is to be used, the boom tip must be fitted with a pulley (see section 2D).

Rabbit line

Before putting out the trolling boom, take a piece of light line or string a little more than twice the length of the boom. Pass this through the boom eye, then tie off both ends at the base of the boom. Once the boom is in a fishing position, the inside end of this string is tied to the swivel on the end of the mainline. Pulling the outer end of the string pulls the mainline out through the boom eye and back to the boat, where it can be rigged for fishing. Once fishing is over, the procedure is reversed, so that when the mainline is taken out of the boom eye, the string is led back in, and can be tied off, ready for next time.

Boom stays

Booms for use with handreels must have good top and bottom stays (see Section 2E). If there is no bottom stay, the boom will lift when a fish strikes, or each time you try to wind the line in quickly. Without a topstay, the boom will bend and may break when a fish is wound in close to the boat and is fighting downwards against the boom.

STAYS FOR HANDREEL BOOMS

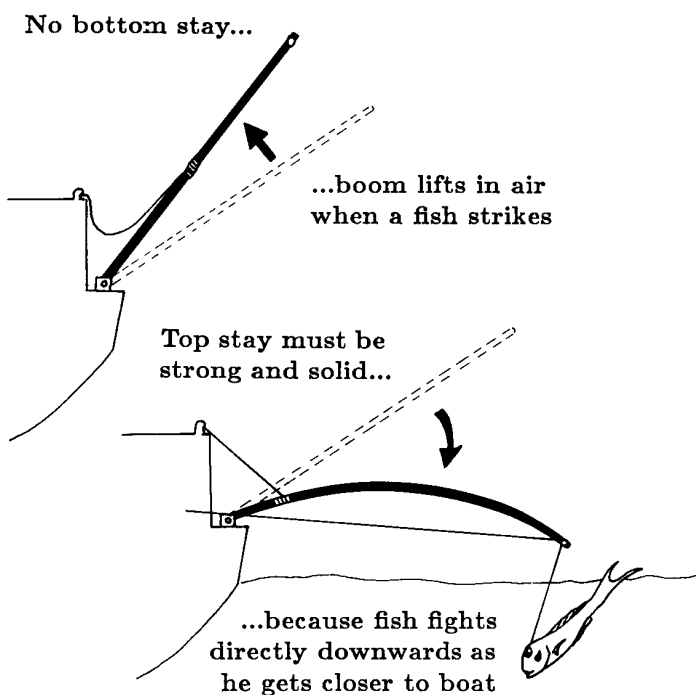

RABBIT LINE

Tie a length of light line through the boom and leave it in place when the boom is not being used

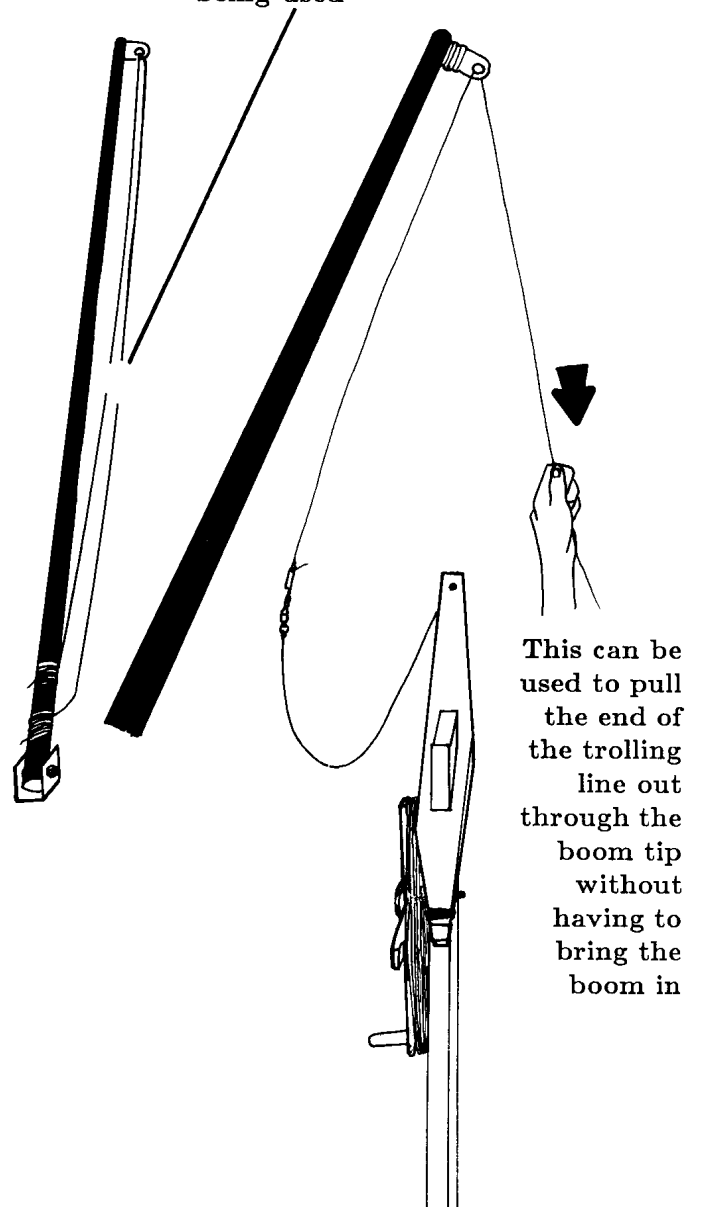

Braking System (Drag)

Unlike a fixed line, there is no shock absorber incorporated into the trolling line itself. This is replaced by the braking system, which also acts as a drag to prevent line over-run due to the reel spinning too fast when a fish strikes.

Most commercially made handreels are fitted with a brake of some type, usually a friction adjustment, which is undoubtedly the best. For the Samoan handreel, a simple but very effective brake can be improvised. This consists of a simple loop of inner tube rubber, attached by means of a rope stop to a fixed point on the boat. This is looped over the reel handle during normal trolling, and lifted off when winding in the line.

The brake loop should be reasonably tight, so that it is difficult to turn the reel manually with one hand. Depending on its strength, adjust the length of the rubber loop so that the handle can move fairly easily through about a quarter of a turn in each direction. If the brake is too loose, the reel will spin too freely on a strike, perhaps causing a tangle, not hooking the fish properly, and paying out a lot of line, which must then be wound back in again. If it is too tight the reel may not turn when a fish strikes, resulting in broken gear or fish breaking off the line.

BRAKE FOR WOODEN HANDREEL

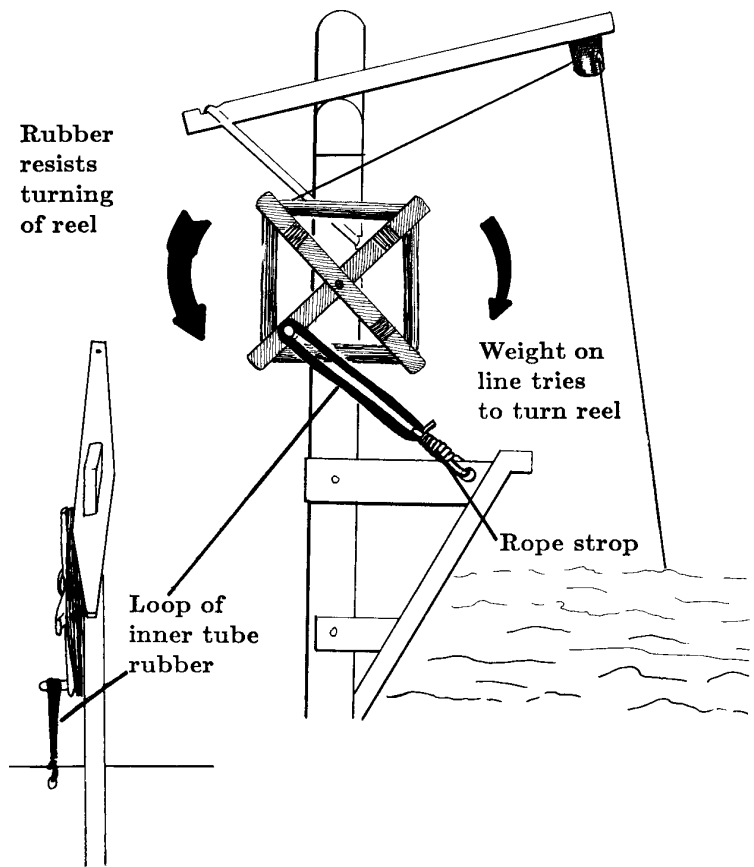

LAZY LINE

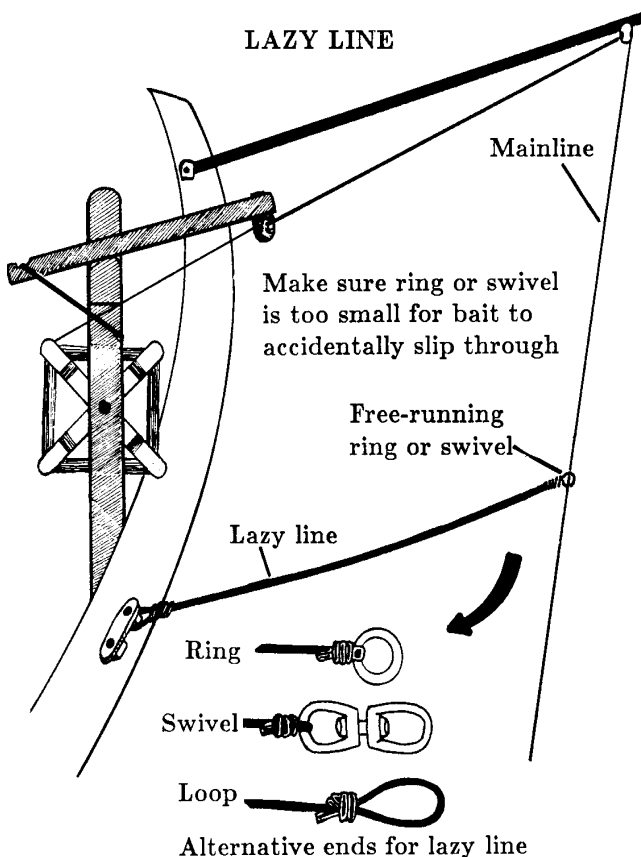

Lazy line

As with a fixed line (Section 31), a lazy line is needed so that the mainline can be pulled inboard when boating a fish. The lazy line cannot be attached to the mainline, but must be free to slide along it. Usually, a steel ring, a large-eyed swivel, or a simple loop is tied onto the end of the lazy line. The mainline should be threaded through this ring OJ: loop before attaching the trace and bait or lure. The ring should be too small for the bait or lure to pass through, so that there is no chance of the lazy line ever slipping off over the end of the trace.

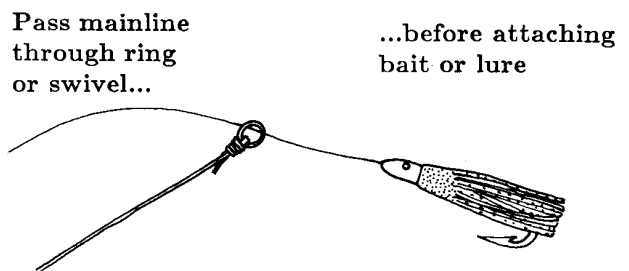

See Section 6E for information on trolling practices using the handreel.

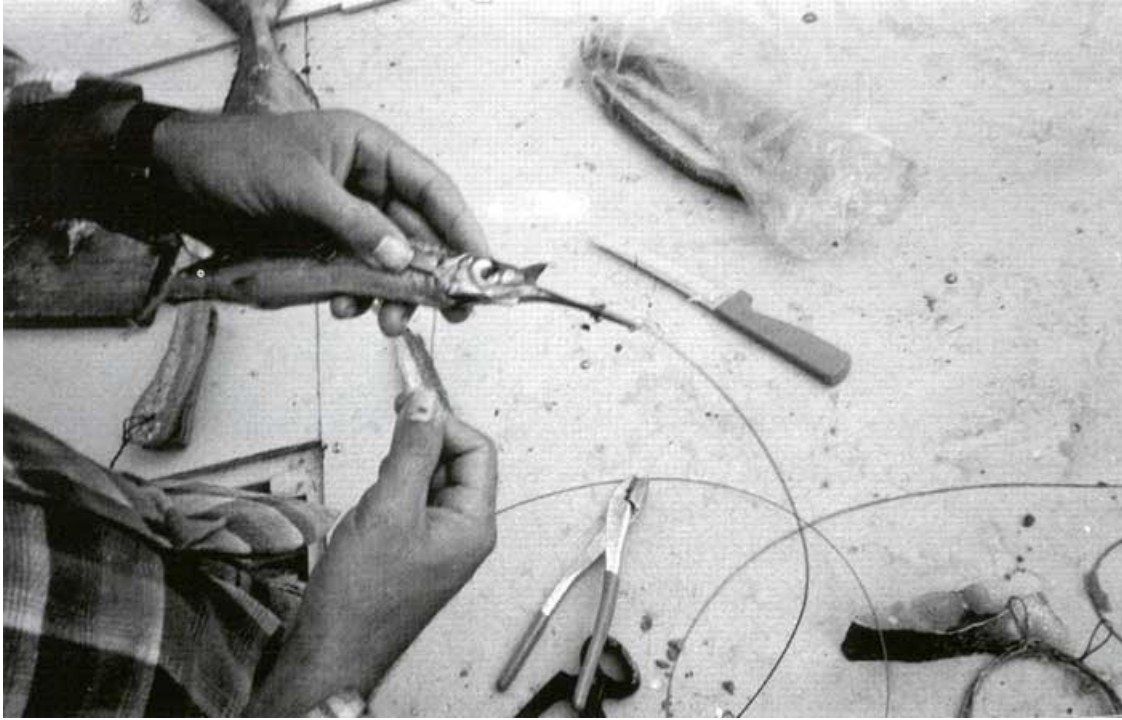

Location: Noumea, New Caledonia

Photo: G.L. Preston

Rigging garfish as trolling bait

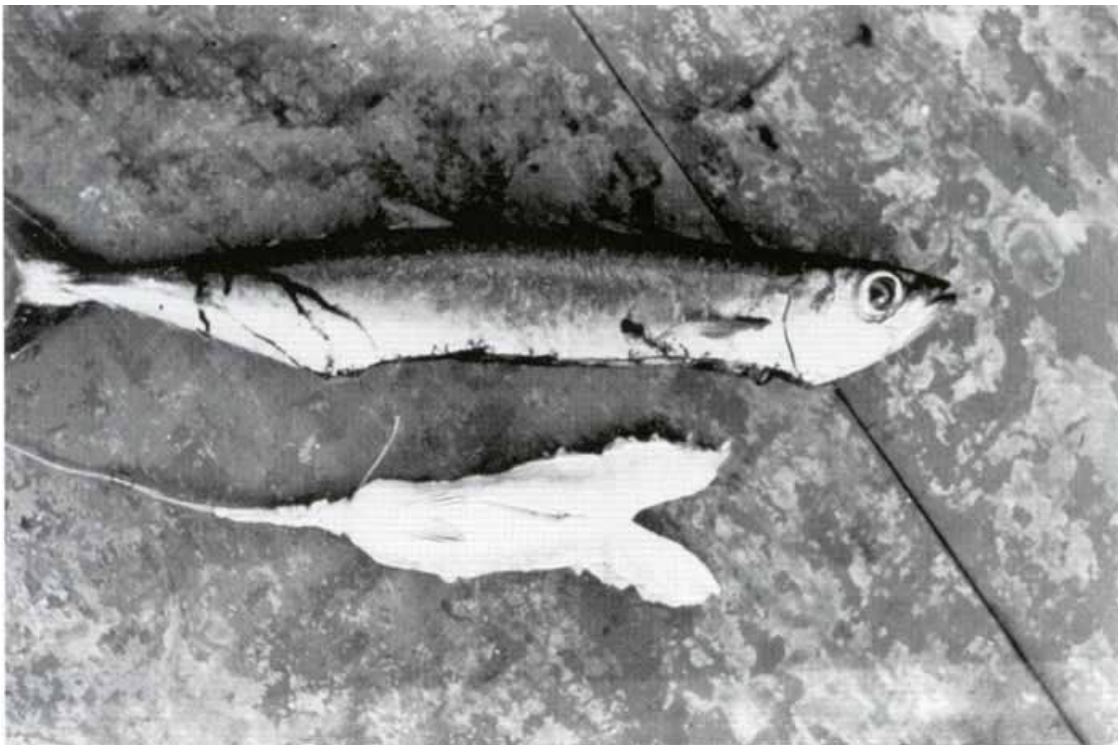

Location: Funafuti, Tivulu

Photo: L.B. Chapman

Rigged belly flap cut from a small scad

CHAPTER 4

BAITS AND LURES

A. BAIT AND LURE TYPES *-Natural Baits -Artificial Lures*

B. RIGGING MACKERELS AND SCADS *-Preparation -The trace -Rigging*

C. RIGGING FLYING FISH AND SMALL, ROUND-BODIED FISH *-Preparation -The trace -Rigging*

D. RIGGING GARFISH AND SMALL, LONG-BODIED FISH *-Preparation -Rigging*

E. RIGGING SEAPIKE AND LARGER, LONG-BODIED FISH *-Preparation -Rigging*

F. RIGGING CUT BAITS *-Cutting off belly flaps -Size and shape -Preparation -Rigging*

G. MAKING OCTOPUS LURES *-Skirts -Heads -Tying rubber skirts -Tying fibre skirts -Protecting lures*

H. RIGGING LURES *-Rigging lures with an attachment point -Rigging octopus and similar lures*

I. LURE MAINTENANCE AND STORAGE *-Keeping lures clean -Checking for damage -Replacing hooks
-Touching up -Storage*

CHAPTER 4: BAIT AND LURES

SECTION A: BAIT AND LURE TYPES

The two major types of bait or lure used when trolling are 'natural' -that is real fish or pieces of fish -and 'artificial', or man-made substitutes for these. In this book, when talking about 'baits', we mean natural baits and, when referring to 'lures', we mean artificial or man-made lures.

BAIT AND LURE TYPES

Baits

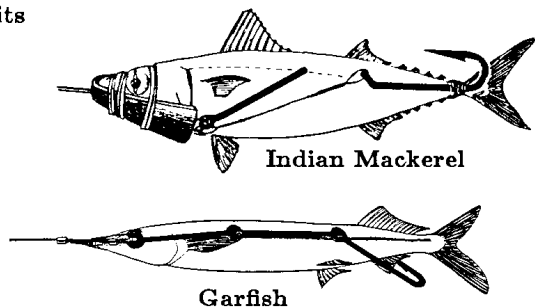

Lures

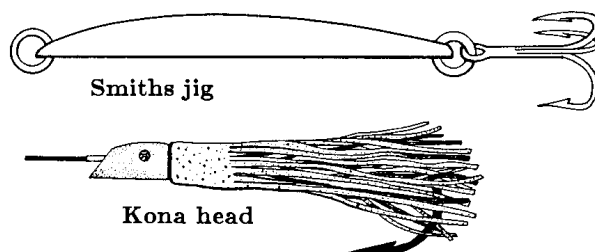

Many things affect the fisherman's choice of whether to use baits or lures. These include their availability, cost, ease of use, and effectiveness for the types of fish he hopes to catch. Natural baits can be caught in most coastal areas, but bait capture can be time-consuming and may only be possible at certain times or seasons. If the fisherman chooses to buy baits, then obviously this will add to his costs, especially as most baits are only good for one or two fish, and deteriorate rapidly. In contrast, artificial lures can be used repeatedly for a long time. Natural baits have to be replaced or re-rigged almost every time a fish is caught, and this is much more time-consuming than fishing with artificial lures. However, most fishermen agree that natural baits are usually more effective than artificial lures, especially in areas where there is plenty of fishing going on, and the fish are wary and difficult to catch.

NATURAL BAIT

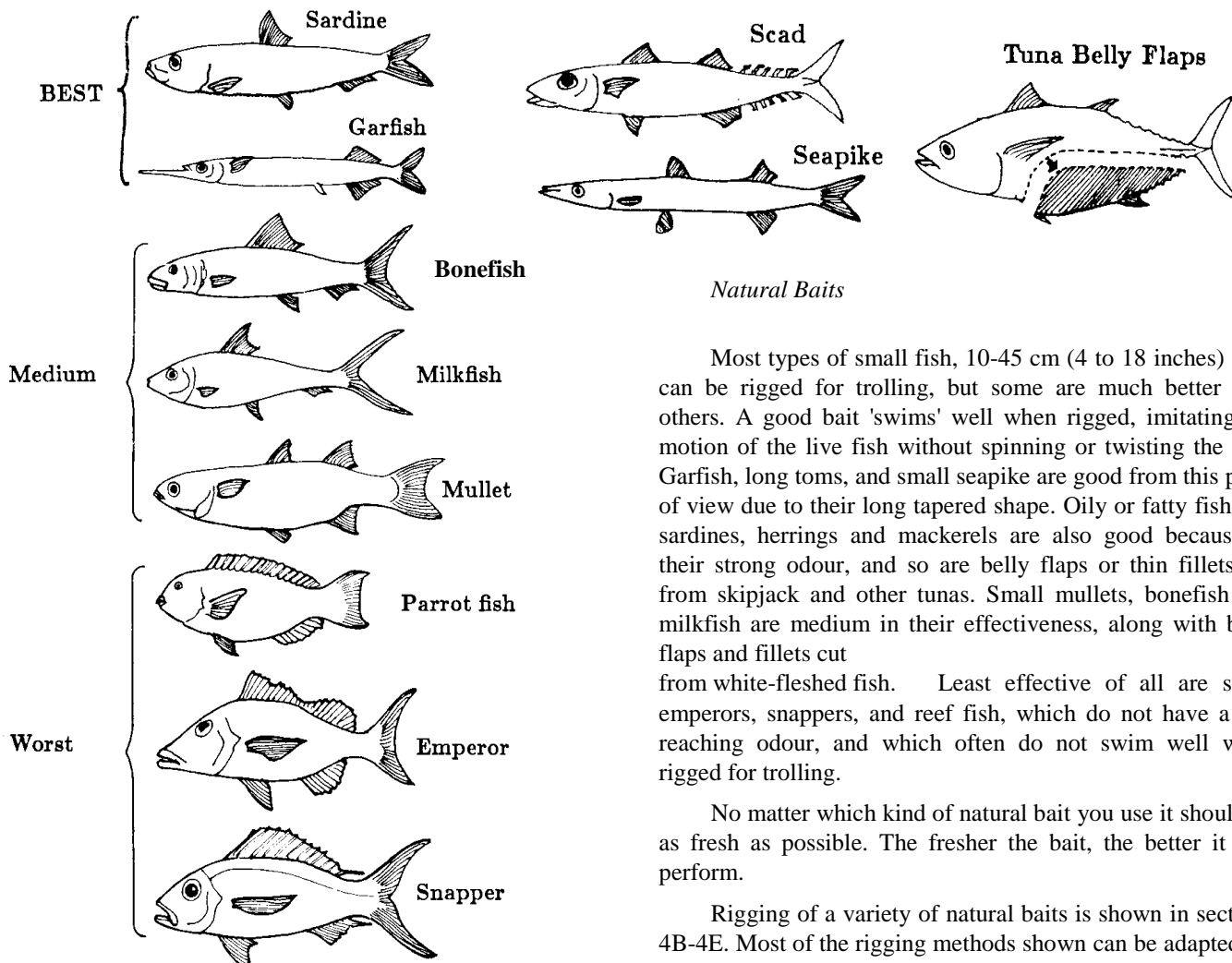

Most types of small fish, 10-45 cm (4 to 18 inches) long can be rigged for trolling, but some are much better than others. A good bait 'swims' well when rigged, imitating the motion of the live fish without spinning or twisting the line. Garfish, long toms, and small seapike are good from this point of view due to their long tapered shape. Oily or fatty fish like sardines, herrings and mackerels are also good because of their strong odour, and so are belly flaps or thin fillets cut from skipjack and other tunas. Small mullets, bonefish and milkfish are medium in their effectiveness, along with belly flaps and fillets cut from white-fleshed fish. Least effective of all are small emperors, snappers, and reef fish, which do not have a far-reaching odour, and which often do not swim well when rigged for trolling.

No matter which kind of natural bait you use it should be as fresh as possible. The fresher the bait, the better it will perform.

Rigging of a variety of natural baits is shown in sections 4B-4E. Most of the rigging methods shown can be adapted for many different bait types.

Artificial Lures

These fall into two main categories, soft lures and hard lures.

SOFT LURES are those which can become seriously damaged during fishing and which have to be periodically patched up. They normally consist of coloured rubber, plastic, feather or cloth decoration fixed onto a re-usable solid head. The most common is the standard rubber 'octopus' or squid lure which is used worldwide. These come in a wide range of colours and sizes and can be very effective in certain situations, for instance when trolling through tuna schools. Section 4G shows how to make and repair octopus lures.

The standard soft lure swims in a straight line with a slight fluttering movement. There are many other types which claim to be more effective for certain types of fishing because they flash, or make bubbles, or dart from side to side, etc. These include hexagon, jet, and Kona lures.

HARD LURES



Barramundi drone

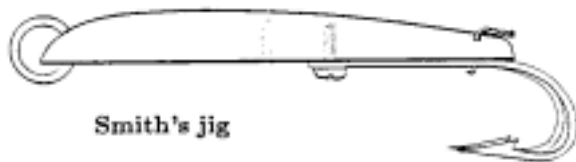

Smith's jig



'Tomic' lure

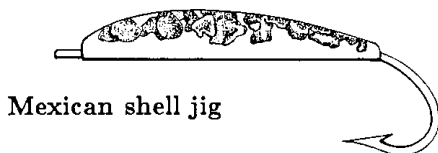

Mexican shell jig

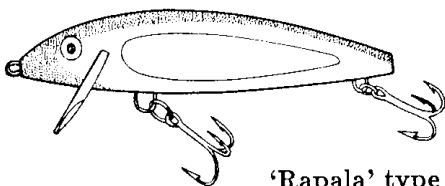

'Rapala' type lure

SOFT LURES

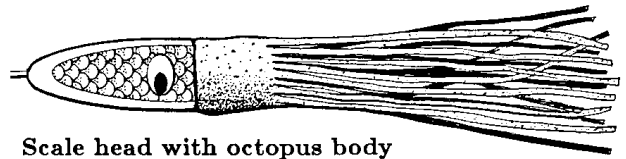

Scale head with octopus body

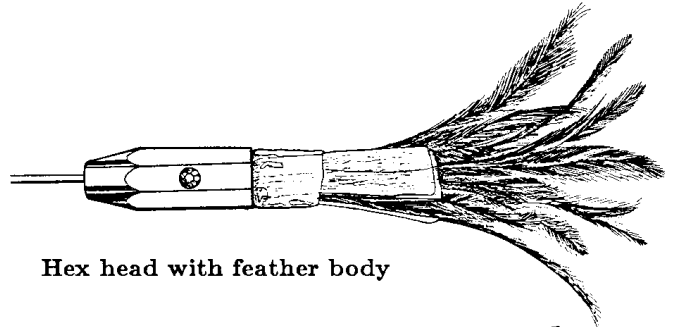

Hex head with feather body

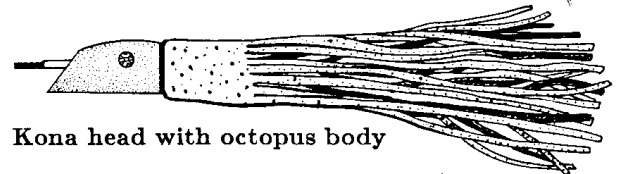

Kona head with octopus body

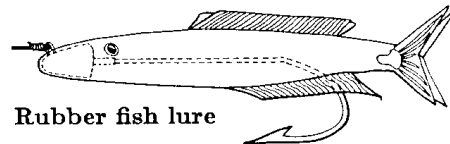

Rubber fish lure

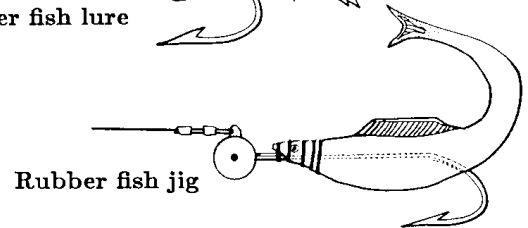

Rubber fish jig

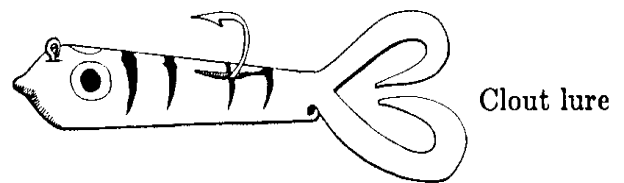

Clout lure

HARD LURES are usually metal or hard plastic and are meant to resist damage from an attacking fish. Many hard lures attract fish by a combination of an erratic swimming motion, and brightly coloured or reflective surfaces. Popular types include spoons, plugs, diving lures and many more. Although durable and resistant, many hard lures suffer from poor hooking rates -that is, many fish which strike the lures do not get hooked. Metallic lures need to be polished regularly to keep them shiny, and the hooks will usually rust rapidly due to the galvanic effect of the lure body. Non-metallic lures will become scratched or chipped and will need repainting or touching up from time to time.

Details of lure rigging and maintenance are shown in sections 4H and 4I.

CHAPTER 4: BAITS AND LURES

SECTION B: RIGGING MACKERELS AND SCADS

True mackerels (different from the much larger Spanish mackerels) are found in estuaries and coastal areas of a number of Pacific Island countries. Scads, which are somewhat similar in appearance, are found near the outer reefs of almost all Pacific islands.

The oily flesh and strong odour of this group of fishes make them good bait fish. However, the high oil content causes them to spoil rapidly, and the flesh can quickly become soft and mushy during towing. They will go soft within a few hours unless they are iced on capture, and they do not freeze well. Herrings and sardines are popular bait among anglers and sport fishermen, but are mostly too small to be used with the heavier commercial type gear described in this book. Small to medium-sized mackerels and scads, from 10 -25cm (4 -10 inches) long, are the best size.

MACKERELS AND SCADS

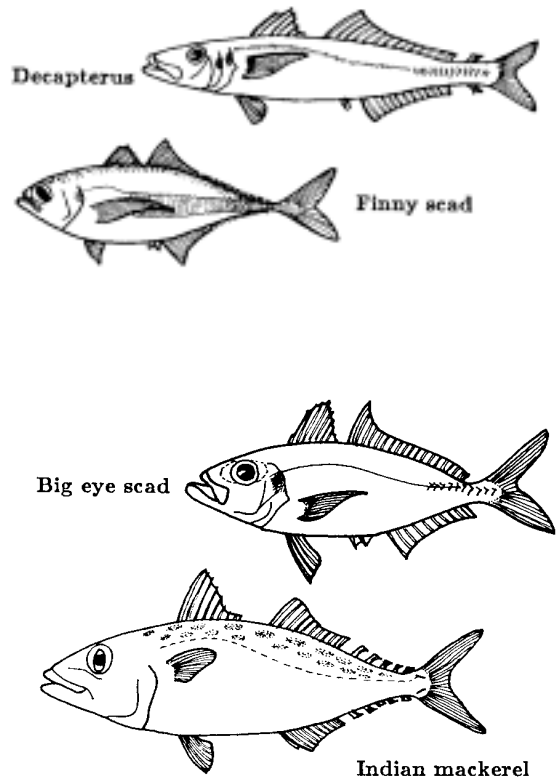

**COMMERCIAL CHIN CAP
(JAPANESE STYLE)**

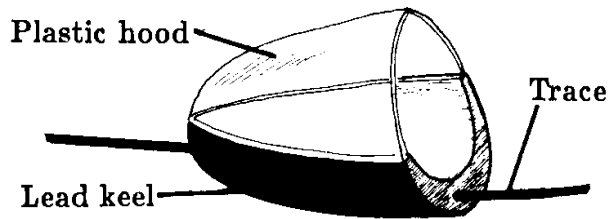

Preparation

Many mackerel like species have a body which is somewhat flattened from side to side and tends to spin around when towed. To prevent this, it is usual to fit a lead 'chin-cap', which acts as a keel and balances the bait in the water. The chin-cap also prevents the mouth of the bait from opening.

Several types of chin-caps are commercially available, but if these cannot be bought locally, a home-made version can be improvised from sheet lead, as shown below. Note that the chin-cap must be threaded onto the trace before rigging the hooks.

HOME-MADE CHIN-CAP

Make hole in middle of rectangular piece of lead

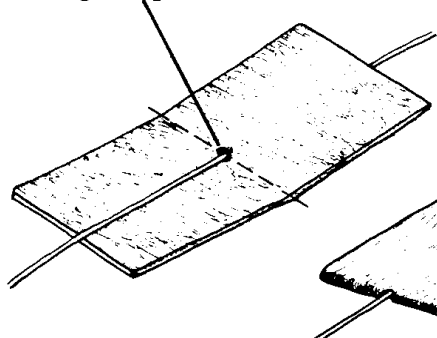

Pass line through and bend over

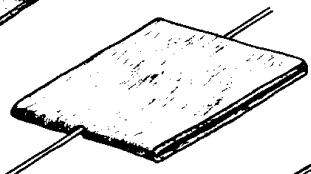

Fold up

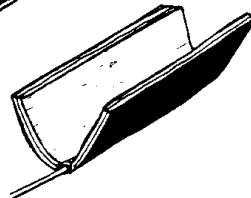

Bend front edges together, trim to shape with cutters

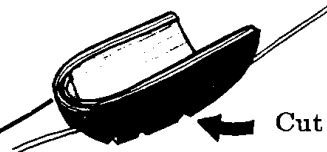

Cut notches beneath

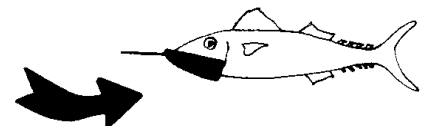

The trace

The trace used should be of wire or cable, rigged with two medium or large single hooks, as shown below. The second hook is attached via a short leader, 5 -8 cm (2 -3 inches) long, to the eye of the main trace (not to the eye of the first hook).

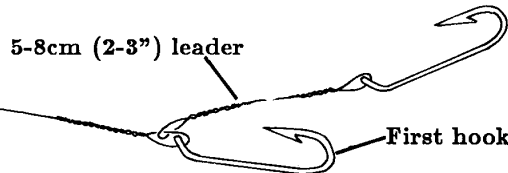
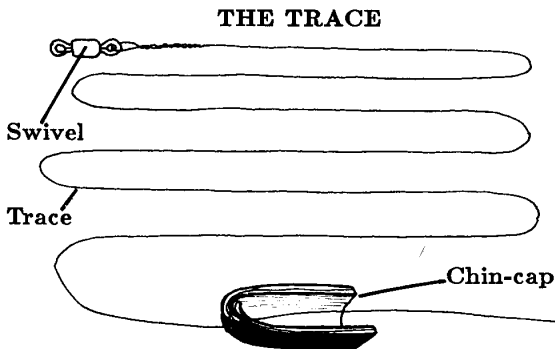

Rigging

With a sharp knife cut two or three notches across the top of the fish's head.

Take the first hook and pass it through the body of the bait below the dorsal fin. Adjust its position so that the shaft lies diagonally over the belly, with the hook eye near the pelvic fin.

Slide the chin-cap down the trace and over the chin of the fish. Ensure that the end part of the trace lies along the bottom of the chin-cap.

Tie the chin-cap firmly onto the head of the fish with rubber bands, dental floss or light twine, using the notches already made.

With rubber bands or twine, tie the shaft of the second hook to the fish's tail.

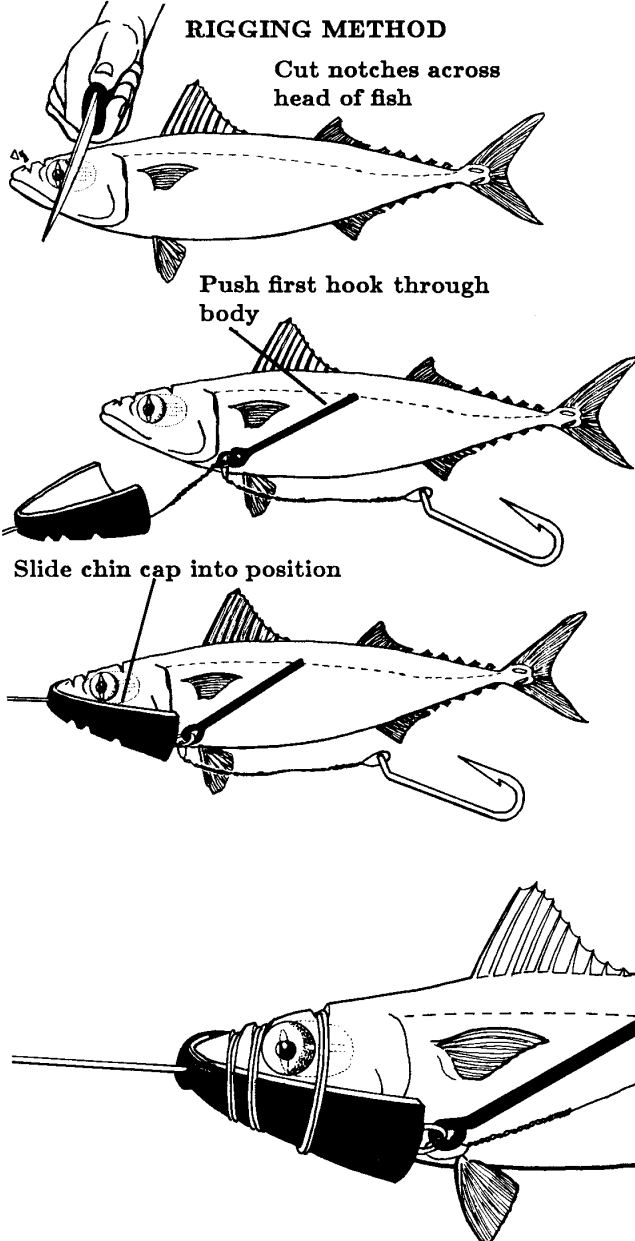

The bait is now ready for use. (Some fishermen prefer to partially cut away the fillet on one or both sides of the bait in order to release more odour. If this is desired, it should be done before rigging the bait.)

CHAPTER 4: BAITS AND LURES

SECTION C: RIGGING FLYING FISH AND SMALL, ROUND-BODIED FISH

Several species of flying fish are present throughout the Pacific, and in many countries these form the basis of important local fisheries. As well as making good eating, flying fish are also excellent bait.

The rigging method shown here is also suitable for small mullets and other species which have a similar body shape.

**COMMERCIAL CHIN CAP
(AMERICAN STYLE)**

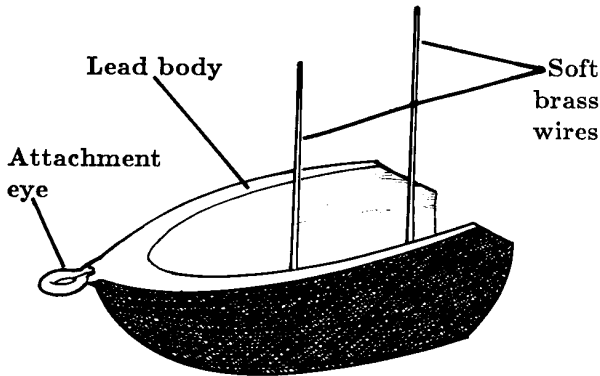

SUITABLE BAITS

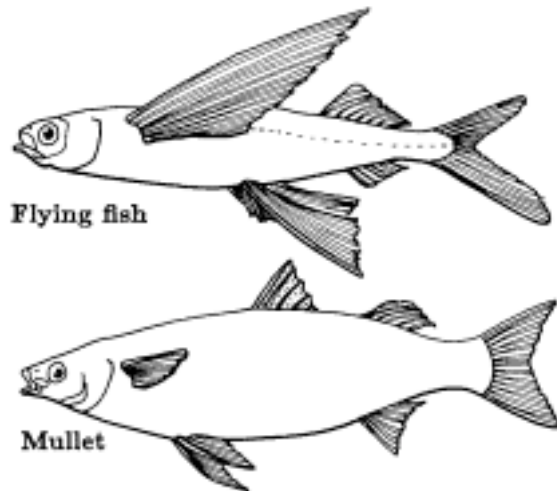

Preparation

As with mackerels and scads (Section 4B) a chin cap is required for this type of rig. The most suitable is the commercially manufactured type shown opposite. Alternatively, the types shown in Section 4B can be used.

For this type of rigging, it is necessary to thread the trace through the body of the fish. The job is made much easier by using a bait needle, which is easy to make from wood or from an old bicycle spoke, heavy galvanised fence wire, etc. Sharpen one end to a point, and hammer the other end flat. Cut or file a notch into the flat end which the trace can be hooked.

BAIT NEEDLE

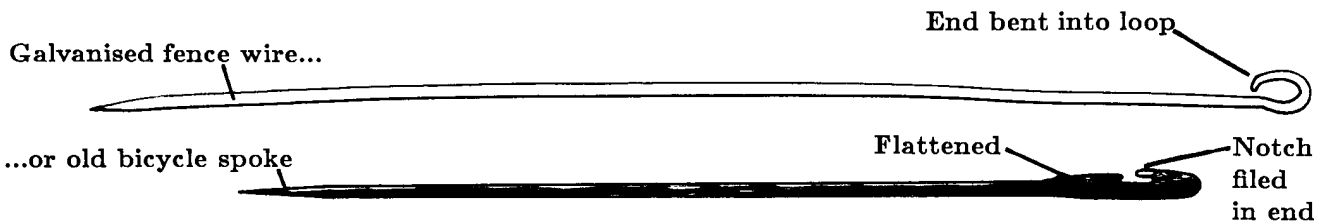

The trace

To rig the flying fish, a wire or cable trace, rigged with a large double hook is needed. The chin-cap should be tied onto the trace with wire or light line, so as not to be lost if it comes loose from the bait when a fish strikes. The double hook should be large enough for the fish to sit neatly between the two points. If a double hook is not available, a large single hook can be used instead. Which-ever type of hook is used, it should be tied rigid, as shown in Section 3G.

THE TRACE

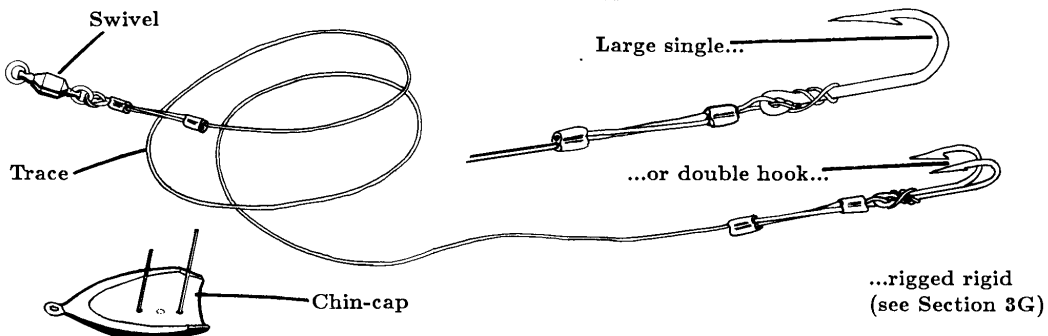

RIGGING METHOD

Rigging

Take the flying fish and cut off both wings close to the base. This will prevent the fish spinning while towing. If you are using a home made chin-cap (as shown in Section 4B), pluck out both eyes to give a good attachment point for the tie-string. (The eyes will fall out during towing anyway).

Using the bait needle thread the leading end of the trace into the anus of the fish, through the body, and out through the mouth.

Pull the trace through until the double hook is close to the fishes body. Gently pull the shank of the hook into the anus of the fish, so that the two points lie on either side of the fishes body. The hook will stay in this position and does not need tying.

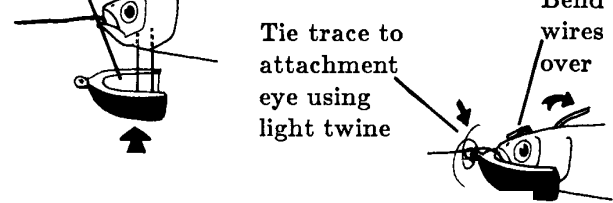
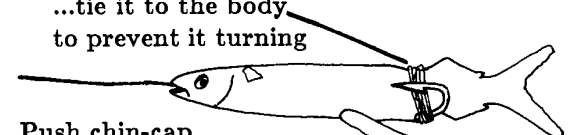
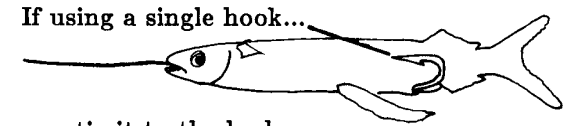
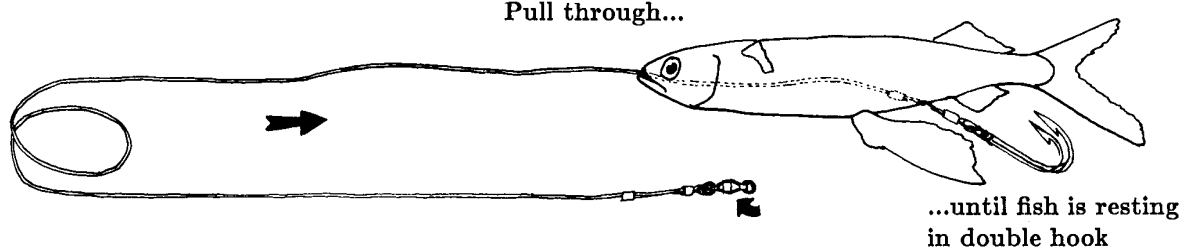
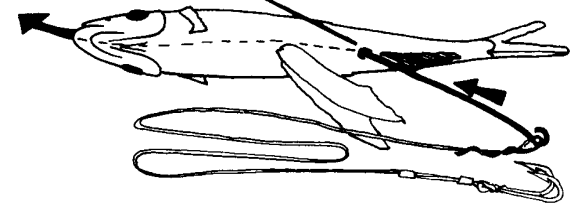
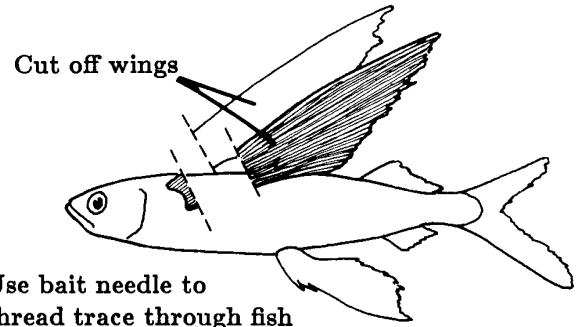

If using a single hook, the procedure is the same, but the hook may need to be tied in place using a rubber band, dental floss or light twine.

Slide the chin-cap down to the fish and push the wire spikes up through the head from underneath. Bend the ends of the spikes over to hold the chin-cap in place.

If using a home-made chin-cap tie it in place using light twine or wire passed through the eye socket. Alternatively, tie onto notches cut across the fishes head as shown in Section 4B.

For home-made chin-cap (see Section 4B) tie on around head...

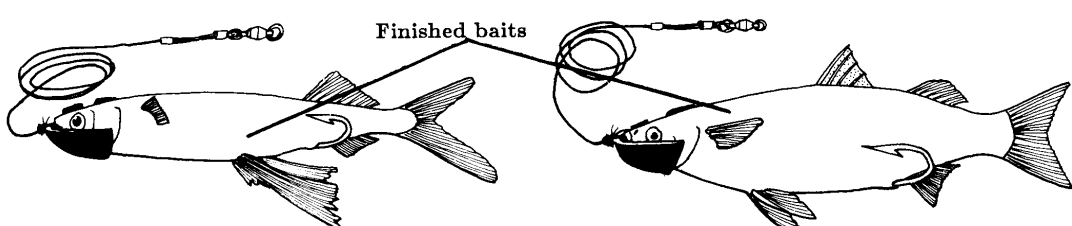
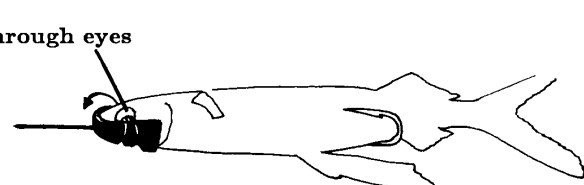
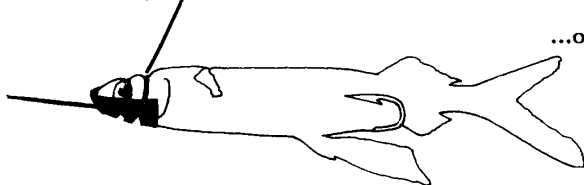

The bait is now ready for use.

CHAPTER 4: BAITS AND LURES

SECTION D: RIGGING GARFISH AND SMALL, LONG-BODIED FISH

Garfish are coastal species found in estuarine areas, near reefs and over weed beds in many Pacific Island countries. They are good bait for Spanish mackerels and a wide range of other coastal or reef-associated pelagic fish. Garfish have a reasonable odour without being too soft and oily. They remain firm after having been frozen, and can be towed for several hours without falling apart.

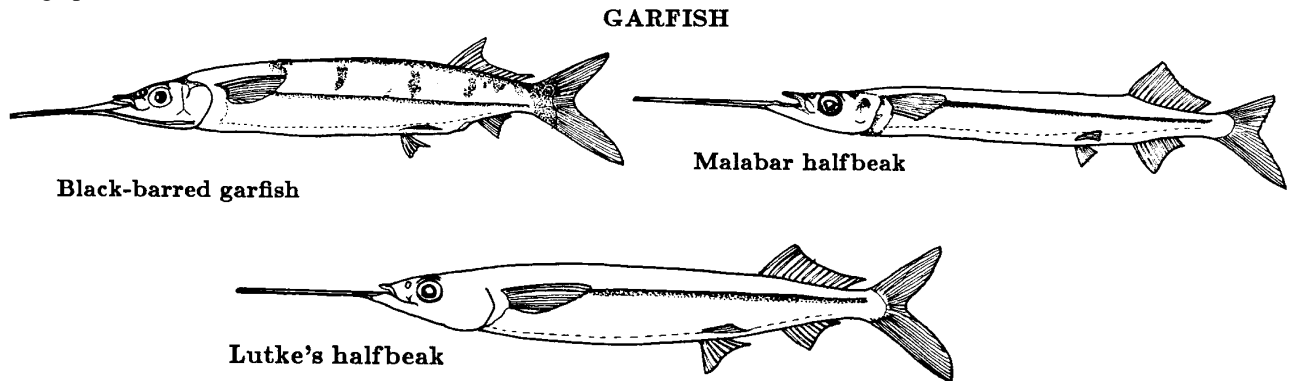

Some garfish species grow to lengths of 45cm (18 inches) or more. The best size for trolling is from 1020cm (4 to 8 inches) excluding the beak. Garfish can be caught in gill nets or by angling using light tackle.

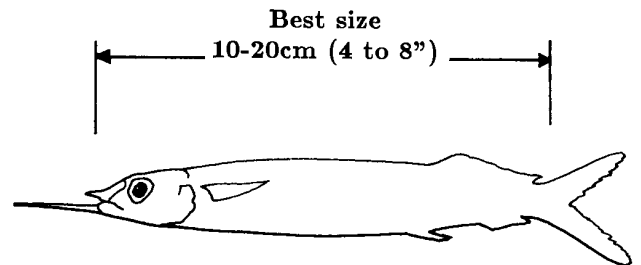

Preparation

To rig the garfish, two (or, if the fish is a large one, three) hooks are needed, ganged together as shown in Section 3B, and rigged on a trace of wire or cable. The hooks should be the same size, and the gap should be at least as wide as the thickest part of the fish. Use oversized rather than undersized hooks if the right size is not available. Use two hooks whenever possible, three when absolutely necessary. A three-hook rig makes the fish swim badly and may cause it to spin, twisting the line.

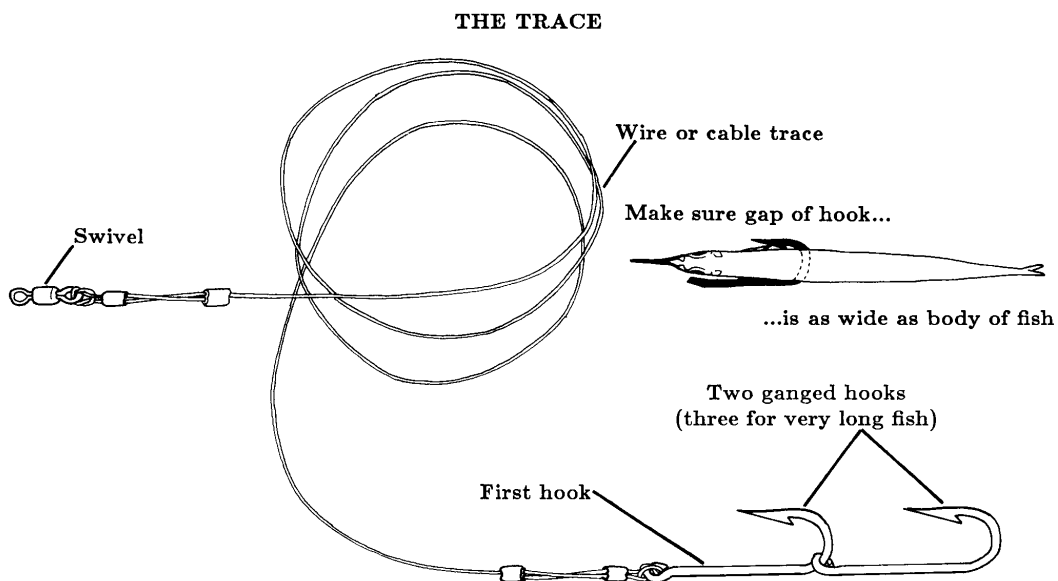

RIGGING METHOD

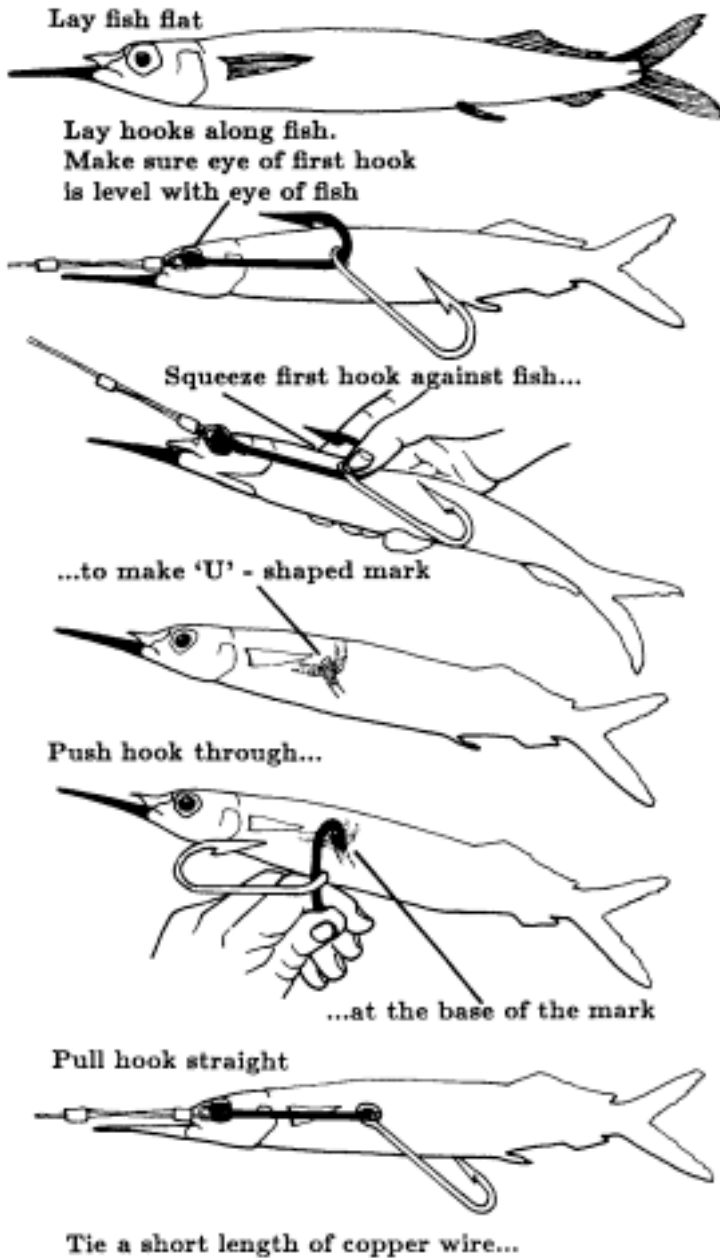

Rigging

Take the garfish and lay it out straight on a flat surface. Lay the trace on top of the fish so that the eye of the first hook lines up with the eye of the garfish. Press the first hook down firmly on the fish to make an impression of the hook on the fishes side.

Use the 'U'-shaped impression made on the fish as a guide to where to insert the hook. Insert the point of the first hook at the base of the 'U'. Push the hook completely through the body, then adjust the position so that the hook eye lies alongside the fishes eye.

If using a larger fish and a three-hook rig, the procedure is slightly different. The trace is laid on the fish, and the eye of the first hook lined up with the fishes eye, as above. However, the second hook is pressed to make an impression on the fishes side. The second hook is inserted through the fishes body, using the impression as a guide. The first hook is then also pushed through the fishes body. The eye of the first hook should line up with the eye of the fish.

In both cases, the last hook (closest to the tail of the fish) is allowed to swing free.

Pass a 15 cm (6-inch) length of light tie-wire through the eye of the first hook and through both eyes of the fish. Twist the wire back on itself to secure it, then make tight wraps around the head, mouth and beak of the fish, working forwards towards the trace. This prevents the mouth of the fish opening, or the beak coming away from the line, both of which can cause the fish to spin during towing. When you come to the end of the wire, break off the rest of the beak.

If the beak was already broken before you started, it may help to pierce a small hole through the upper and lower jaws of the garfish, using the point of a hook or other sharp object. The tie-wire can be passed through this hole several times to help keep the mouth closed.

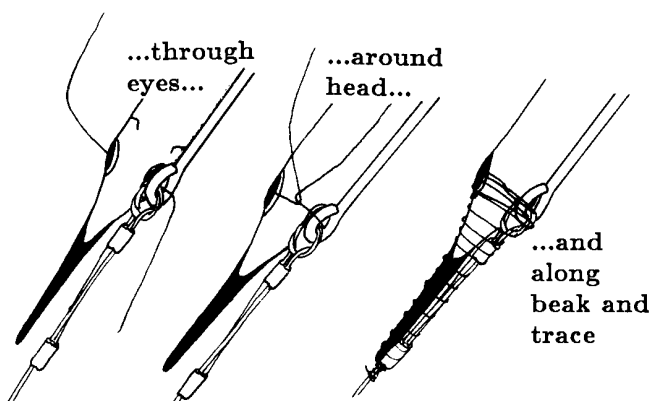

If beak is broken, make hole through jaws...

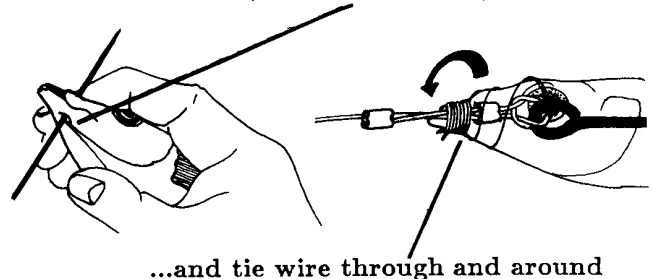

...and tie wire through and around

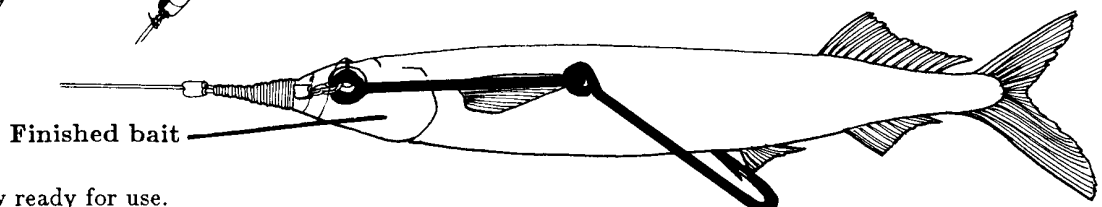

The bait is now ready for use.

CHAPTER 4: BAITS AND LURES

SECTION E: RIGGING SEAPIKE AND LARGER, LONG-BODIED FISH

Seapike are actually small barracudas, and are caught throughout the Pacific Islands in nets, by trolling, and when line-fishing in lagoons or passes, especially at night. There are several species of barracuda, some of which attain large adult sizes. In many locations, barracuda have been known to cause ciguatera fish poisoning, and are unpopular eating fish, so their use as bait avoids waste.

The most practical sized seapike for trolling are those between about 25 -60 cm (10 and 24 inches) long. Other long-bodied fish, such as long-toms, large garfish, etc., are equally suitable. The rigging method shown here is intended to allow a single bait to be re-used several times, thus avoiding waste of these reasonably large fish.

SUITABLE BAIT

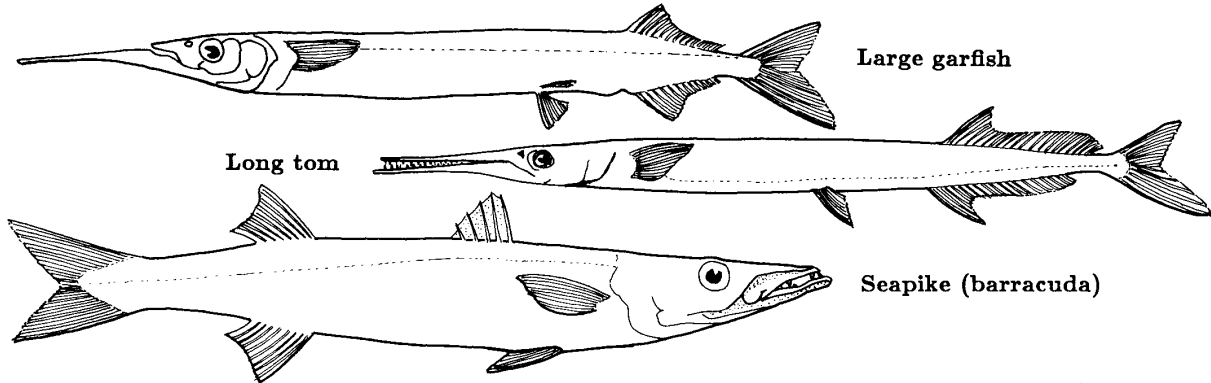

Preparation

The fishing rig is a trace of cable fitted with two medium-sized single hooks ganged together, or a large single or double hook (see Section 3B), depending on the size of the bait. If using ganged hooks, tie the first one rigid as shown in Section 3G.

When making the rig, thread a box swivel, torpedo swivel or similar item onto the cable as shown. The swivel should be of a size such that it holds quite tightly on the cable, but can be slid along by hard pulling.

THE TRACE

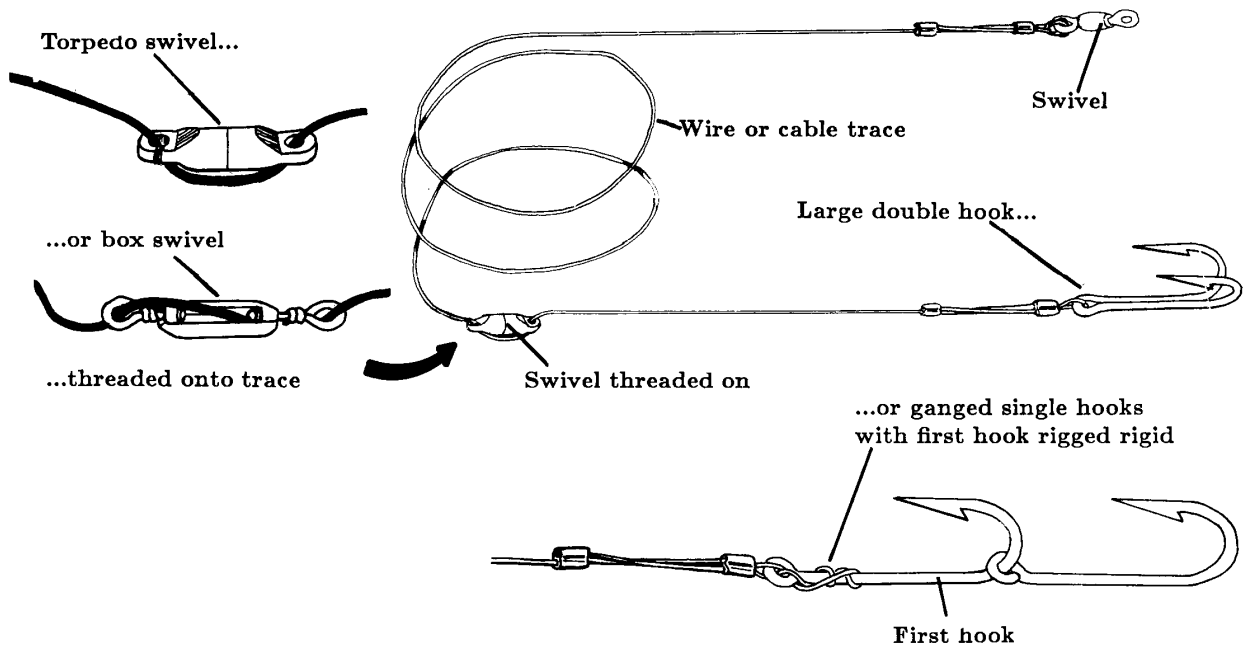

RIGGING METHOD

Partially fillet fish. Cut up to beginning of body cavity.

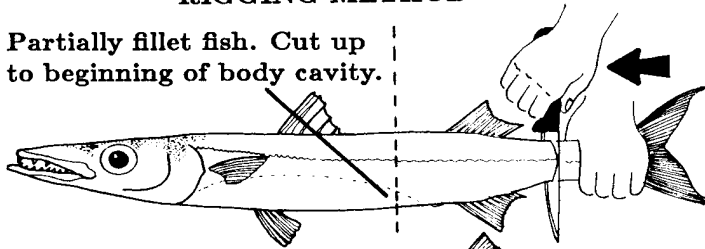

Rigging

Lay the fish on a flat surface. With a sharp knife, partially fillet the fish by cutting alongside the backbone from the tail towards the head on both sides. Fillet as far forward as is necessary to open up the back part of the belly cavity. Do not cut the fillets completely off the fish.

Cut or break out the backbone and tail where the fillets have been separated from it.

Do not cut off fillets

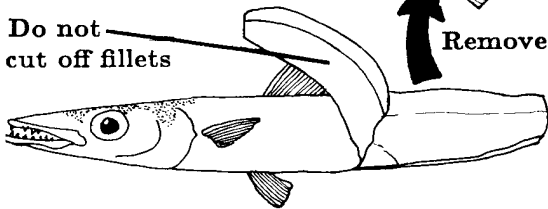

Remove backbone

Using a bait needle (see Section 4C) pass the trace in between the fillets, through the gut cavity and throat of the fish, and out through the mouth. Pull the trace through until the hooks lie between the fillets.

Thread trace through body cavity using bait needle

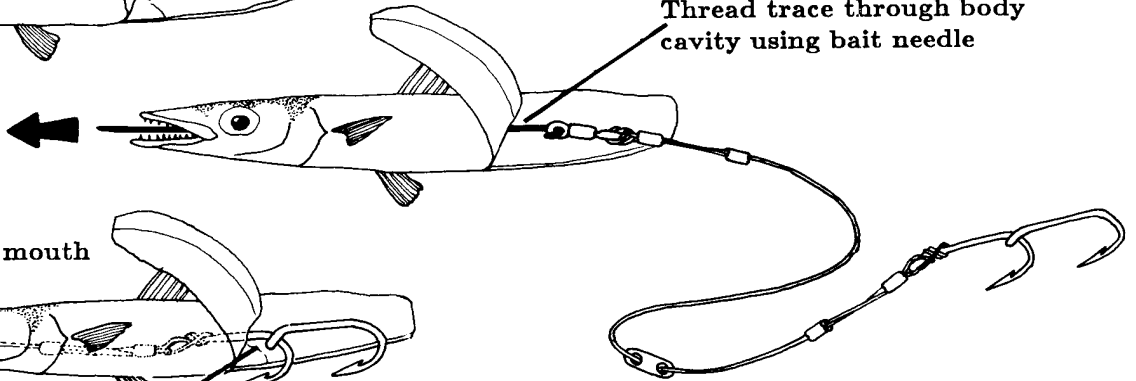

Slide swivel into mouth

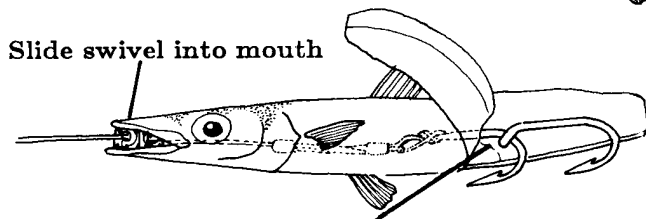

Pull hooks close to body.

Slide the swivel along the trace and into the fishes mouth. Tightly wrap a 15cm (6-inch) length of tie-wire around the fishes mouth several times, closing it firmly over the swivel. The swivel will then act as a stopper and prevent the bait from sliding too freely along the trace. (If using large garfish, wire the beak closely onto the trace as shown in Section 4D).

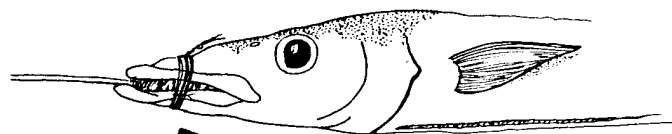

Tie mouth shut with wire

By gripping the head firmly, pull the bait along the trace until the hook is just covered by the two fillets.

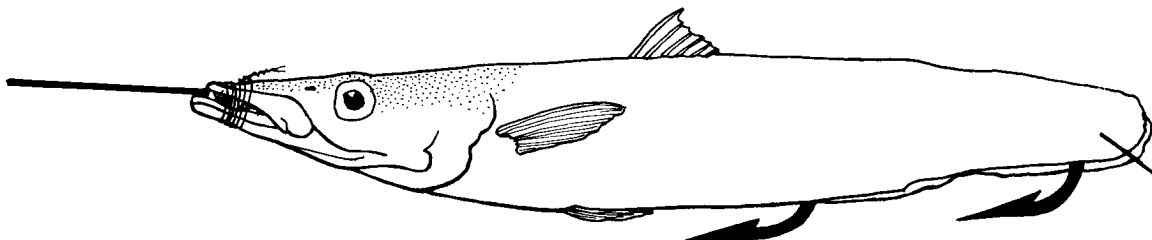

Bait ready to use. Leave about 2 cm (1 inch) tail

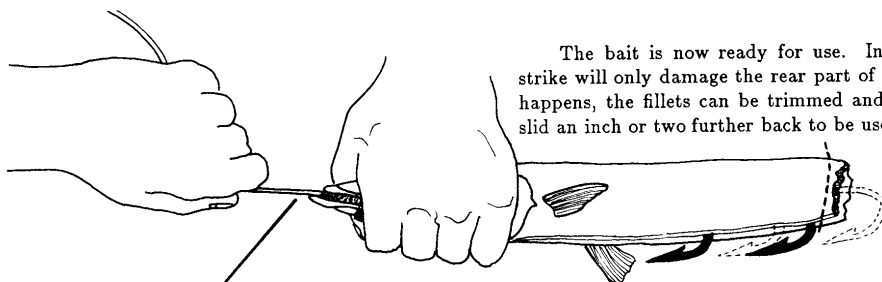

If bait is damaged, hooks can be pulled forward and tail trimmed ready for use again

The bait is now ready for use. In many cases, a strike will only damage the rear part of the bait. If this happens, the fillets can be trimmed and the whole bait slid an inch or two further back to be used again.

CHAPTER 4: BAITS AND LURES

SECTION F: RIGGING CUT BAITS

'Cut baits' are baits cut from the least desirable part of fish which will be eaten, or from fish which are intended for bait but which are too large to troll whole.

Belly flaps are the walls of the fishes belly cavity, and are the best cut baits of all. This part of the fish is usually tough, and is often infested with parasites and therefore not of very good eating quality. The outer skin, a strong membrane lining the gut cavity, and, often, a series of bones inside the flap itself, all help the bait to remain firm and keep its shape during towing.

The best belly flaps are those cut from skipjack, small (under 10 kgs, or about 25 lbs) yellowfin, and other tunas. They have a good odour and are about the right size, shape and thickness (1 -2 cm, or about 1/2 -1 inch). Wahoo and Spanish mackerels also give good belly flaps, and many other species are suitable.

Strip baits are strips of flesh, usually with the skin left on, cut from large belly flaps or from any other part of the fish.

SUITABLE BAITS

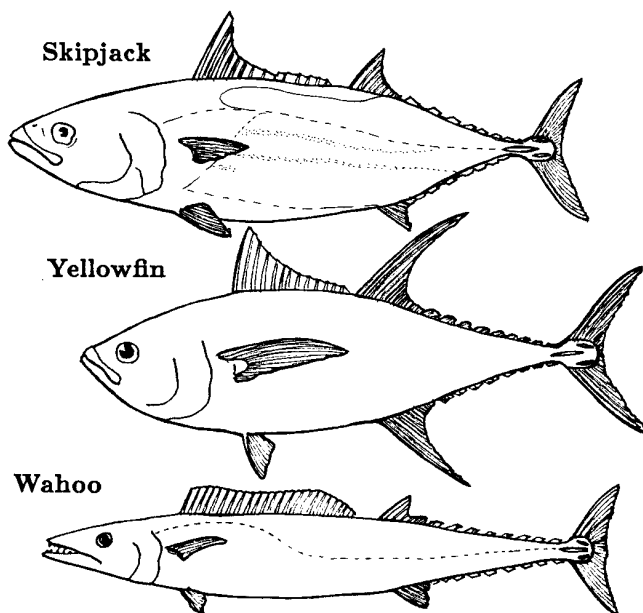

REMOVING BELLY FLAPS...

...FROM SMALLER FISH

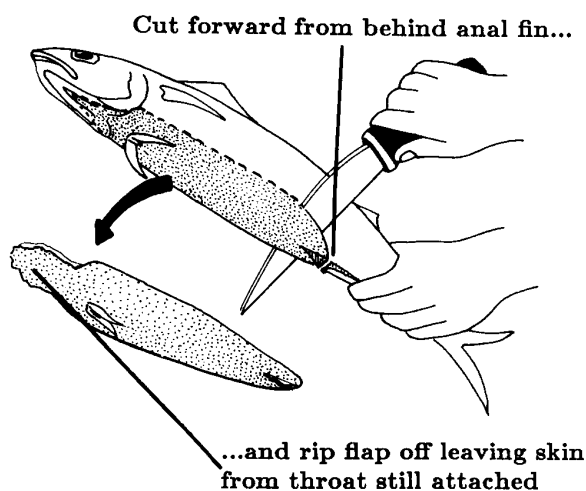

Cutting off belly flaps

The way to cut the belly flap from the fish depends on the size of the fish and how it will ultimately be prepared or processed for sale. For small, whole tunas, the best way is -to hold the fish by the tail and cut forward from behind the anal fin to behind the gills, then rip the cut piece off by tearing forward and down. This results in both flaps being joined together, with a sheet of skin from under the gills still attached. The skin can be used in rigging the flaps (see facing page).

For larger fish, the belly should be slit from vent to throat, and the flaps trimmed off one at a time. If the fish is to be filleted, the flaps can be trimmed off the fillets.

... FROM LARGER FISH

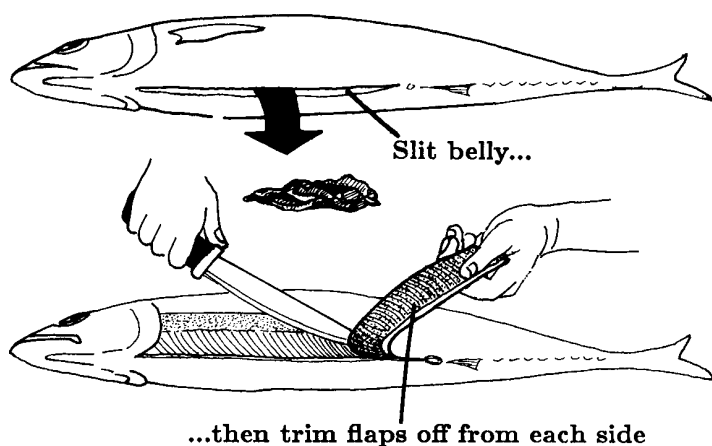

...FROM FISH THAT WILL BE FILLETED

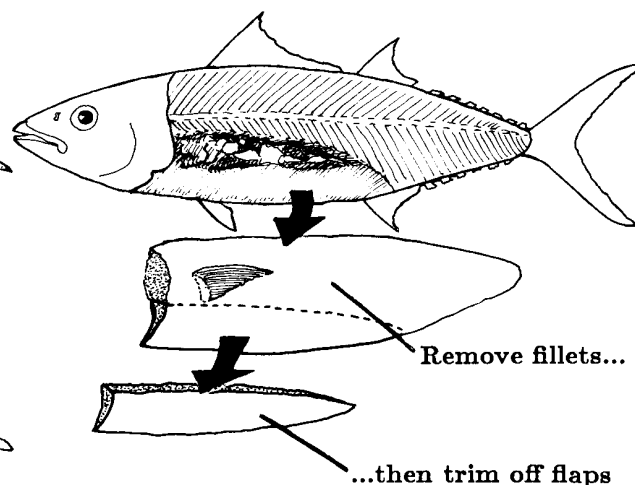

Size and Shape

Belly flaps from smaller fish should be left joined together with the skin from under the gills still attached. Larger belly flaps should be trimmed so that they are 15 - 20cm (6 to 8 inches) long by about 5 cm (2 inches) across at the widest part, tapering to a point at one end. A long triangular shape is ideal. Several baits like this may be cut from one large belly flap.

Fillets or other pieces of fish can also be used as cut baits by trimming them to the same triangular shape. However, they will not hold together as well as a belly flap and may become raggy during towing. Cut baits should always have the skin left on one side, and should be cut thin enough so that the hook point can protrude clearly when rigged.

SIZE AND SHAPE

Leave smaller flaps double

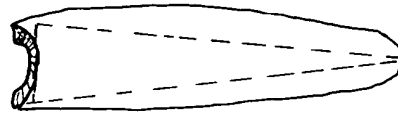

Trim larger flaps to size

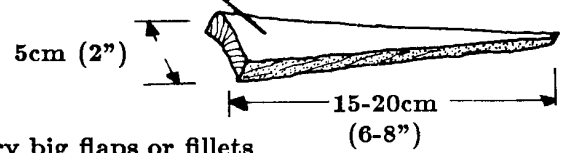

Very big flaps or fillets will give several baits

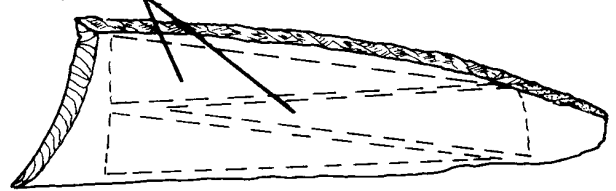

THE TRACE

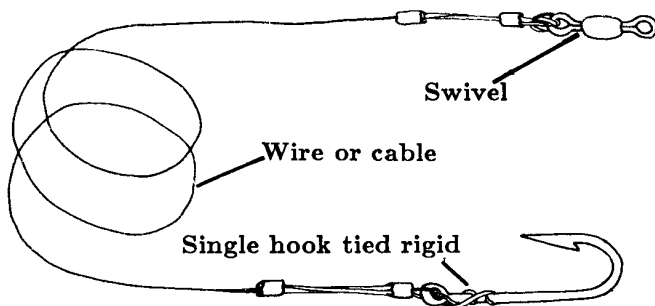

Preparation

A cable or wire trace is required and this should be rigged with a large single hook, tied rigid as shown in Section 3G.

RIGGING METHOD...

...FOR SMALL BELLY FLAPS

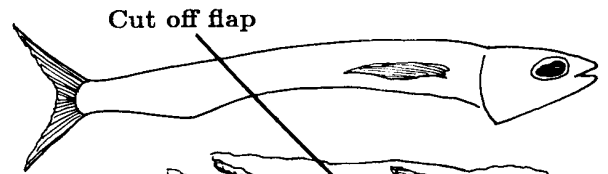

Trim off anal fin to leave 'V'-shaped tail **Leave loose skin on front**

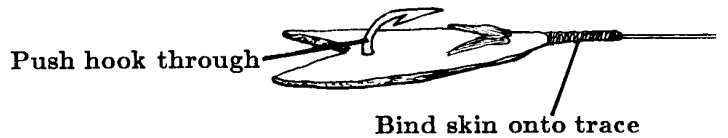

Rigging

For small flaps with skin still attached, push the hook through the centreline of the bait forward of the vent.

With light twine or cotton, tie the loose skin onto the trace by wrapping tightly.

Cut out the anal fin from behind the hook to leave a 'V' shaped gap. This forms an artificial 'tail' which will flutter during towing.

...FOR CUT BAITES

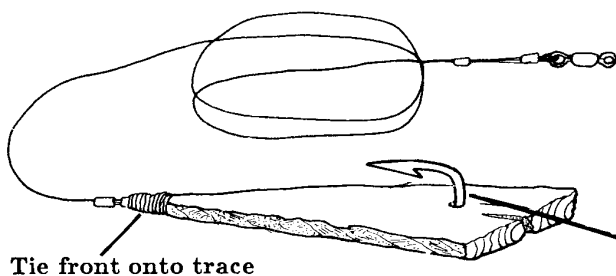
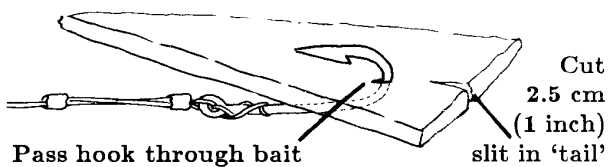

Rigging a cut bait is very similar. Cut a slit 2 cm (1 inch) into the base or 'tail' of the bait. This will give it a little extra motion during towing.

Push the hook through the bait about 4 -5cm (1 to 2 inches) from the 'tail'.

Using twine, wire or rubber bands, tie the pointed end of the bait tightly onto the trace, to prevent it sagging on the hook.

The bait is now ready for use.

Make sure bait is thin enough so that hook sticks out

CHAPTER 4: BAITES AND LURES

SECTION G: MAKING 'OCTOPUS' LURES

Of the 'hard' and 'soft' lures described in Section 4A, one basic type has become especially popular in the Pacific region because of the ease with which it can be made and used. This is the 'octopus' lure, so called because the plastic lure skirt looks like a small octopus. There are many other lures which are made to the same basic pattern, that is a skirt of feathers, fibres or other material bound around a solid head, which has a hole drilled through it to take the trace. Feather and jet jigs, ruby-eyes, pearl head, squid, hexagon and Kona lures are all in this same group.

MATERIALS FOR LURE SKIRTS

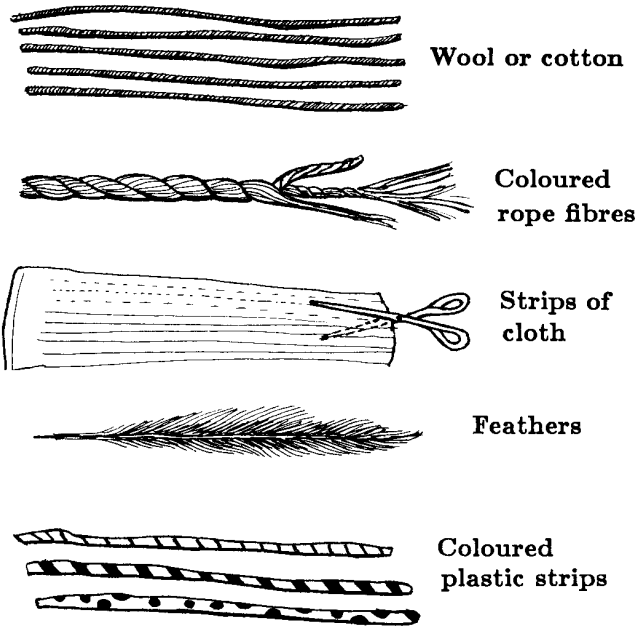

COMMERCIAL OCTOPUS LURE TYPES

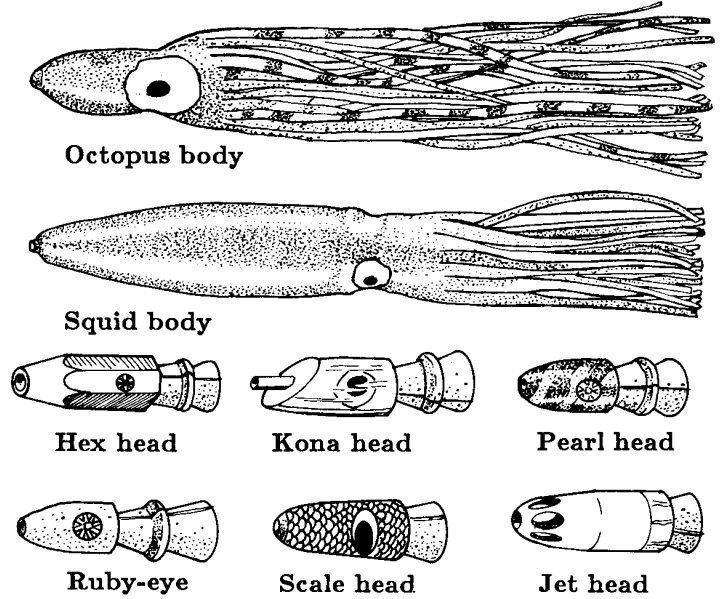

Skirts

In preparing these lures, a variety of materials can be used for the skirt. Commercially available types consist of a moulded rubber or plastic cylinder fused at one end and cut into tassels at the other. These are brightly coloured and come in a variety of patterns and sizes. Other skirt materials, such as dyed feathers and iridescent plastic fibres ('firtail') are also commercially available. Alternatively, a variety of household materials can be used including coloured rope fibres, strips of cloth, cut-up plastic or string bags, wool, chicken feathers and a wide range of other items.

Heads

The best heads to use are those specially manufactured for the purpose. They come in a variety of sizes and colours, are made of bright or iridescent plastic or shell, and are usually weighted with a solid lead core. The tapered neck ensures that the skirt will not slip off. If commercially made heads are not available, alternatives can be improvised. An ordinary egg-shaped lead fishing sinker can be used with octopus or squid skirts. Sheet lead rolled into a cylinder can be used with other lure materials if a groove is scored or crimped around the middle or a lip bent onto the end. Other materials which can be used include metal, plastic resins or wood, depending on locally available materials.

MATERIALS FOR LURE HEADS

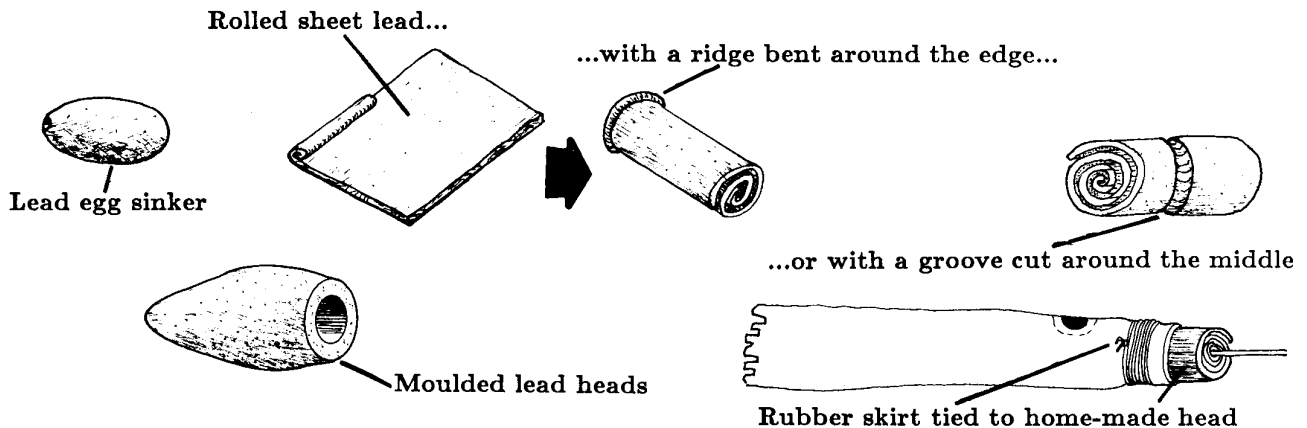

Tying rubber skirts

Attaching an octopus or squid skirt to a lure head is easy, if awkward. The skirt should be the right size for the head or slightly oversized. The sealed end of the head is cut off to leave a little smaller than the head width. The skirt is then turned inside out, and moistened with saliva so that the head can be pushed through. Once the base of the neck is level with the cut end of the skirt, the skirt is tied on tightly with several wraps of cotton or twine. The twine is secured with several overhand knots, and then the skirt folded back into the correct position.

TYING ON FIBRE SKIRTS

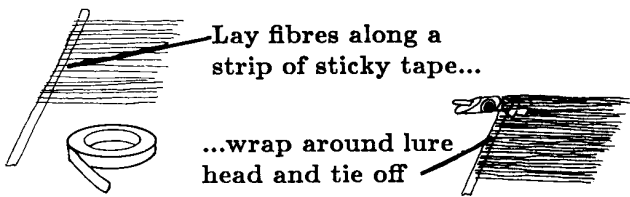

OR

Wrap twine around lure several times...



...adding a few fibres with each turn...

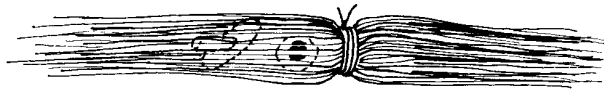

...until you have enough...



...then double back and tie again

Protecting lures

Some lure materials, especially feathers, quickly become ragged in use and lose their streamlined shape. This can be prevented, and the feathers protected by tying on a protective sheath. Sheet plastic, such as a strong carrier bag, can be used. Dried dolphin-fish skin is also good for this purpose.

To fit the sheath, just cut the plastic into a strip half as wide as the length of the lure and more than long enough to go completely round the lure head. Tie it on very tight, and then fold back the leading edge. If the plastic is too stiff to fold easily, or holds the lure material too closely together, cut one or two slits into it to loosen it as necessary.

Wrap piece of plastic or skin round lure...

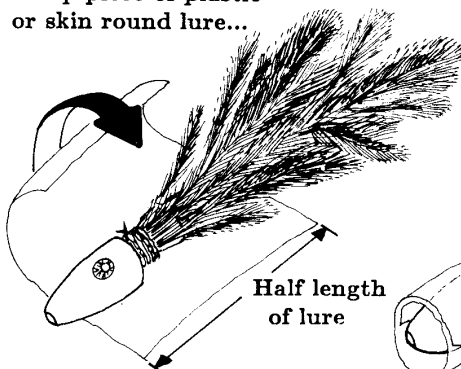

PROTECTING SKIRTS

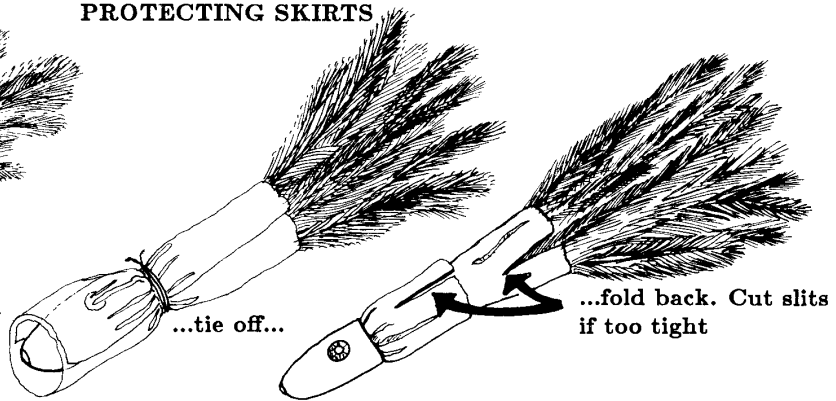

TYING RUBBER SKIRTS

Cut tip off skirt, to leave hole which will be a tight fit

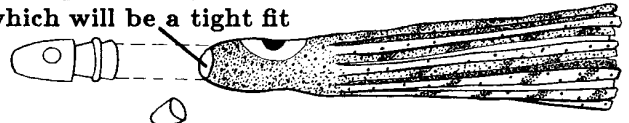

Turn skirt inside out and pass head through backwards

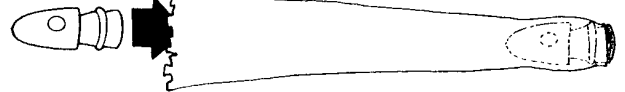

Tie skirt on using dental floss, cotton, or light twine

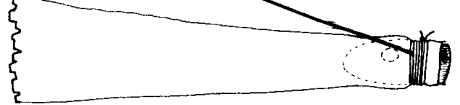

Turn skirt back



Tying fibre skirts

When using fibres or feathers to make up a lure, the easiest way is to stick a single layer of strands onto a length of sticky tape. Wrap the tape around the lure head several times until you have enough fibres on it, then tie the tape down tightly using dental floss or light twine. If you have no sticky tape, start by wrapping the twine, and then add a little lure material with each extra wrap. By building up little by little, it is easier to ensure the lure material is evenly distributed round the head, and that each piece is properly secured. Finish tying by making several overhand knots. With long fibres a long leading edge doubled back will add to the body of the lure and save on the number of strands you need to add.

CHAPTER 4: BAITS AND LURES

SECTION H: RIGGING LURES

Artificial lures are available in a variety of shapes, sizes, and colours. Even so, they are normally rigged in one of only two different ways, depending on whether they have a hole drilled through the head (many soft lures) or an attachment point of some sort (some soft lures and most hard lures).

Like baits, most lures should normally be rigged on wire or cable. Only use a nylon or other non-metallic trace when you are reasonably confident that the fish you will catch cannot bite through it.

LURE ATTACHMENT POINTS

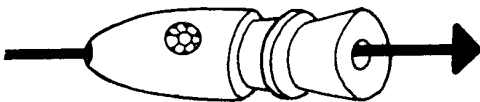

Trace is threaded through lure head...

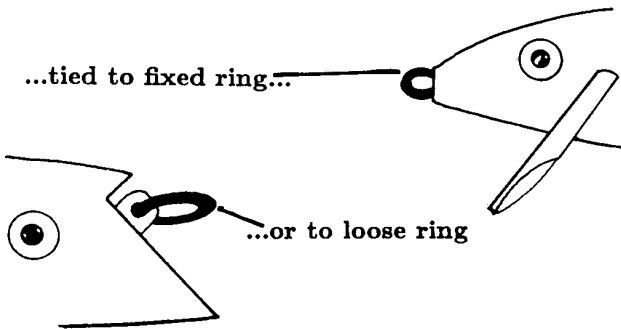

...tied to fixed ring...

...or to loose ring

SOME EXAMPLES

Trace threaded through

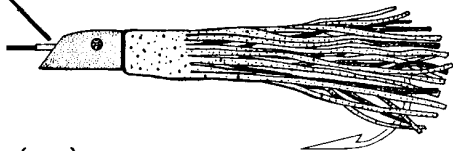

Fixed ring (eye)

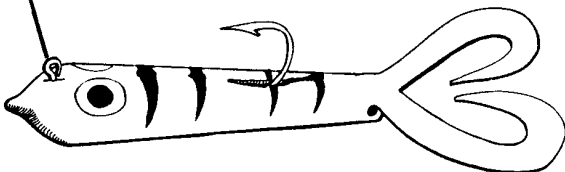

Loose ring

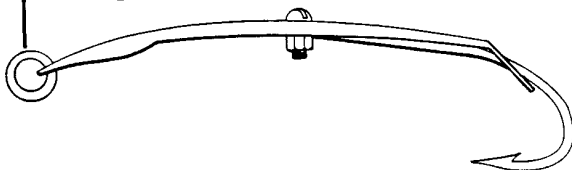

TRACES FOR LURES



Only use nylon when you are catching fish which cannot bite through it

Rigging lures with an attachment point

Many lures have an attachment ring or eye into which the trace can be fastened directly by tying or crimping, depending on the trace material. Alternatively a snap swivel, Hawaiian hook or similar fastener can be used so that the lure on a particular trace can be changed over. This saves on trace material and makes lure storage easier, but care must be taken that the fastener is strong and not liable to come open when struck or bitten by a fighting fish.

ATTACHMENT USING CLIPS...

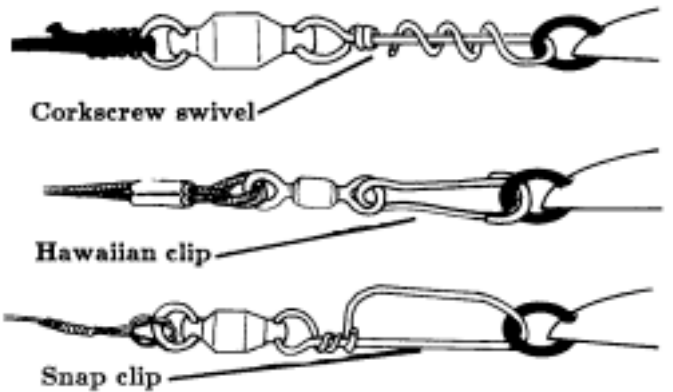

Corkscrew swivel

Hawaiian clip

Snap clip

These allow lures to be changed over using the same trace

...OR DIRECTLY

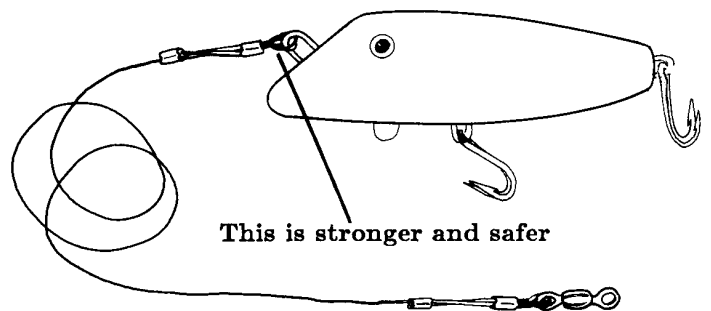

This is stronger and safer

Since many lures in this category are designed to spin, dart from side to side, or otherwise attract fish by their erratic movement, it is normal, and usually essential, to rig a swivel onto the forward end of the trace to prevent twisting of the mainline.

RIGGING OCTOPUS LURES

Rigging octopus and similar lures

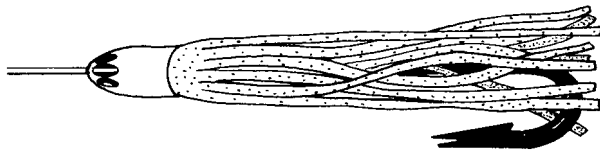

Ways to make these lures are described in Section 4G. They all have a solid head with a hole drilled through it.

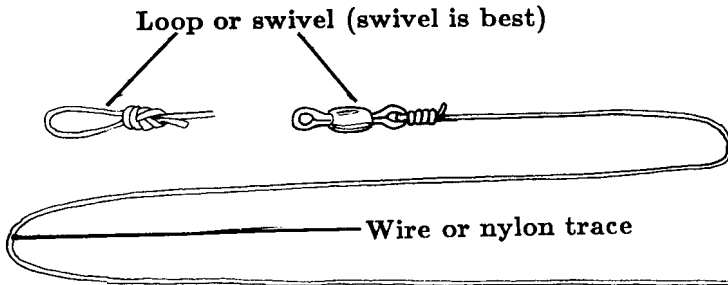

To rig these lures, the trace is just threaded through the lure before the ends are tied or crimped. These lures are often rigged on monofilament nylon as they are used for catching tunas, which cannot bite through it. It is normal to use a double hook of a size such that the points protrude slightly through the skirt. However, on larger lures, a large single hook, or ganged hooks, are preferred by some fishermen.

When rigging this type of lure, the hook should be tied on first, then the stopper position (see below) determined, the stopper fixed on, the lure threaded on the trace, and finally, the other end of the trace finished off.

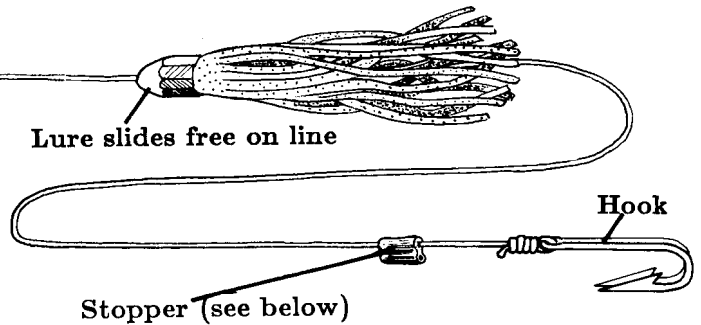

Stoppers

The best position for the hook is at the tail end of the skirt. This increases the number of hookups when the fish only nip at the tail of the lure. However, since the lure is free to slide along the trace, it will normally be pushed up against the hook during towing, with the result that the hook is too far forward. To avoid this, a stopper can be put on the trace. This may be a crimp, a series of plastic beads, a rubber band or a piece of twine tied lightly on the trace, depending on the trace material, and the choice available. It is very bad practice to tie a knot as a stopper, since this will greatly weaken the line.

POSITIONING THE HOOK IN THE LURE

Lure tries to slide back down line, so hook is too far forward

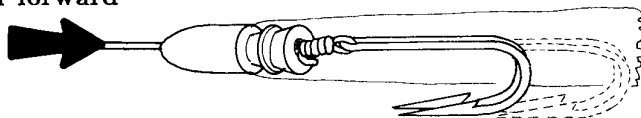

This is where the lure should be

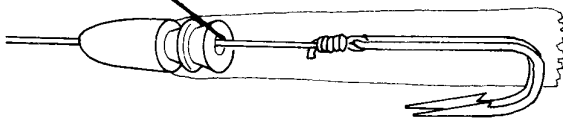

To keep it there, fit a stopper onto the line

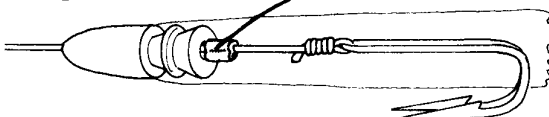

Never knot the trace to make a stopper. This weakens the line

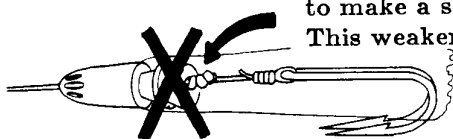

A stopper can be...

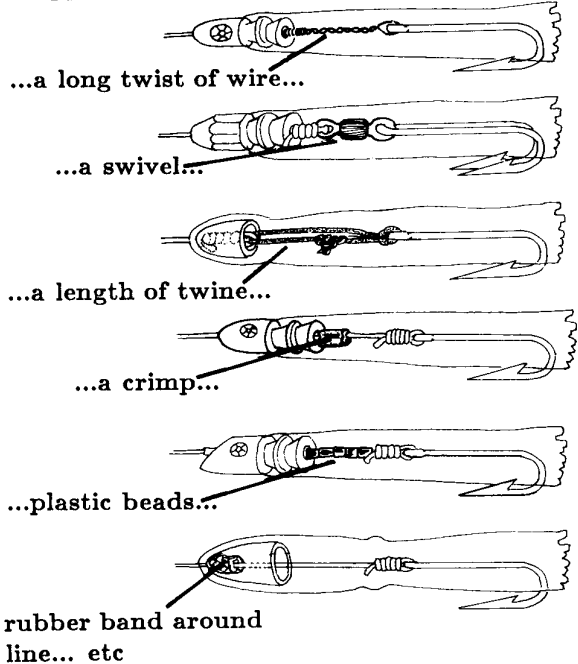

Even though ordinary octopus lures tow without swimming or darting about, it is still good practice to rig a swivel on the forward end of the trace. This is because a hooked fish will sometimes spin and cause the line to twist if not attended to quickly. When rigging Kona and other flat-headed lures, which spin and twist continually during towing, a swivel on the forward end of the trace is needed.

CHAPTER 4: BAITS AND LURES

SECTION I: LURE MAINTENANCE AND STORAGE

A major advantage of artificial lures is that they last a long time compared to natural baits. However, many types of lures will spoil rapidly unless they are properly cleaned and stored when not being used. This is especially true of metal lures, which, because they usually contain more than one type of metal, suffer from the effects of galvanic action. This means that some parts of the lure -often the hook -will rust quickly unless the salt water is washed off them after use.

KEEPING LURES CLEAN

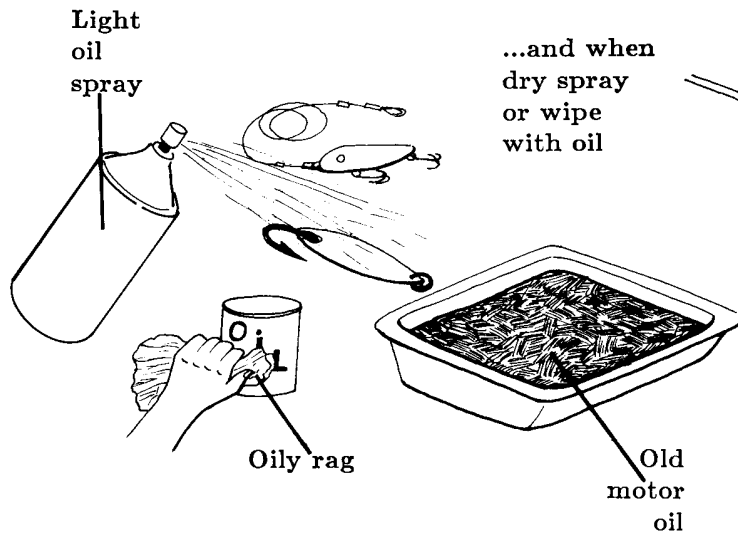
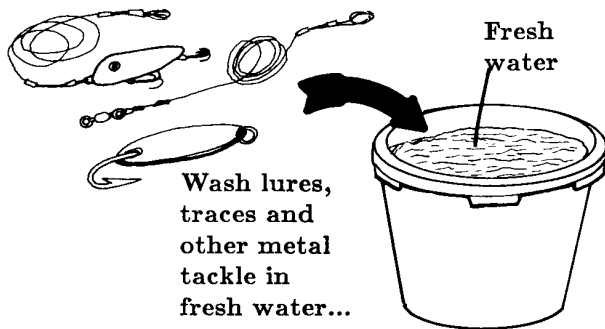

Checking for damage

Before putting the gear away, check the lures and traces carefully for damage and deterioration. In particular, check for:

- bent, cracked or rusting hooks;
- rusting, fraying or kinks in wire and cable;
- abrasion or knots in monofilament and multifilament lines;
- sleeves, knots and splices which are slipping or coming undone;
- damage done to lure bodies by fish teeth.

Decide whether the damage needs repair before the next trip. In doing so, remember that neglect of the gear means you may lose the next big fish to strike.

METAL LURES

Should be cleaned and oiled regularly...

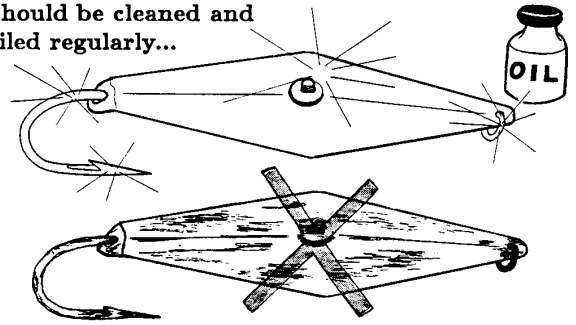

...or they will rust up and become useless

Keeping lures clean

It is good practice to rinse all lures and traces after the fishing trip is over. When dry, spray metal parts with CRC, WD-40 or a similar light lubricant, or wipe them with an oily rag. Keep new gear separate from that which has already been used, so that the new gear does not become contaminated with salt.

CHECK FOR DAMAGE

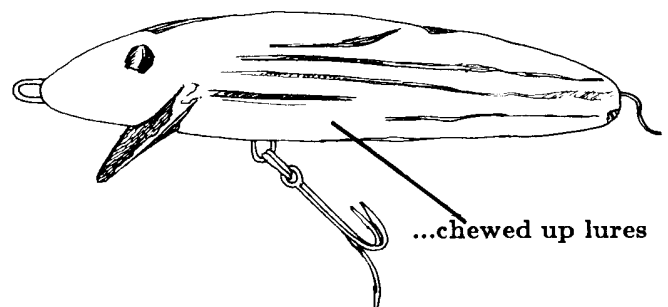
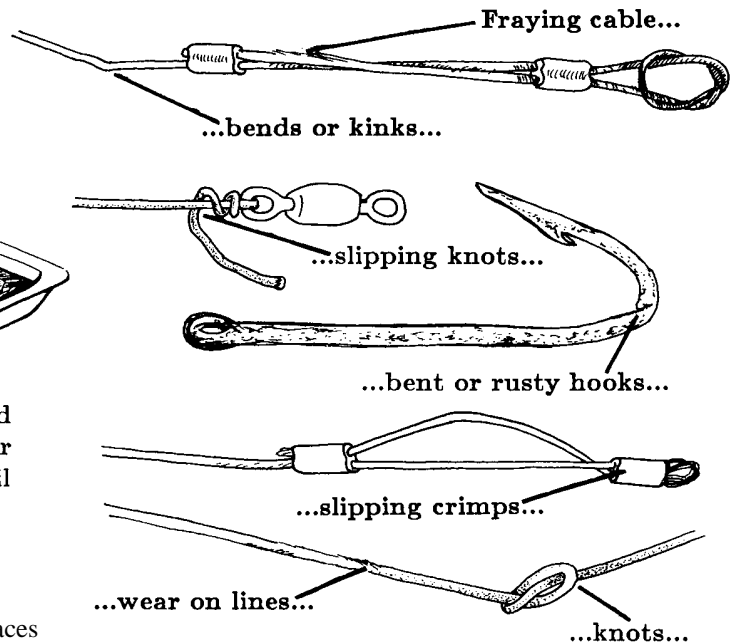

Replacing hooks

Keeping hooks in good order is very important. A lot of hard lures suffer from bad hookup rates, and this will be made worse if the hooks are blunt or bent out of shape. Hook sharpening is described in Section 3B. When a hook gets to be very rusty, or if it has been bent and straightened several times, it should be replaced. Also, consider changing the hook(s) on any lure which shows a consistently bad hookup rate, as it (they) may be too small, or the wrong shape for the lure. Try to avoid those lures which have permanently attached hooks that cannot be changed, or those with special types of hooks which may be hard to get.

Touching up

Coloured plastic, wooden or metal lures will in time become chipped and scratched and gouged by fish's teeth. As these lures are often quite expensive, they are worth fixing up whenever possible. Fibreglass filler putty can be used to fill in deep cuts and gouges in lures, and paintwork can be touched up or redone using nail varnish, car paint or model paint, all of which come in small bottles and bright colours. Repairs to octopus-type lure skirts can be made by tying on new lure material as described in Section 4G.

TOUCHING UP

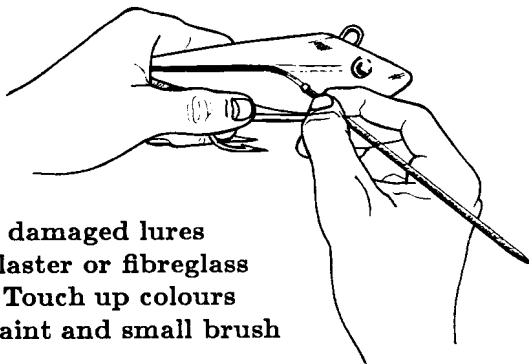

Fix up damaged lures with plaster or fibreglass paste. Touch up colours with paint and small brush

STORAGE

Store lines on old plastic bottles...

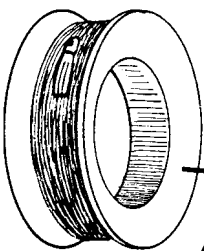

...or on plastic handcasters

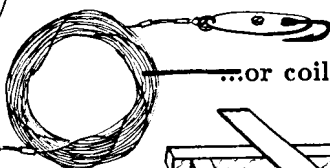

...or coiled in loops

Never store lines on frames like this - they will kink

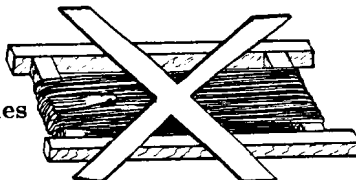

REPLACING HOOKS

If you get many strikes which do not hook up...

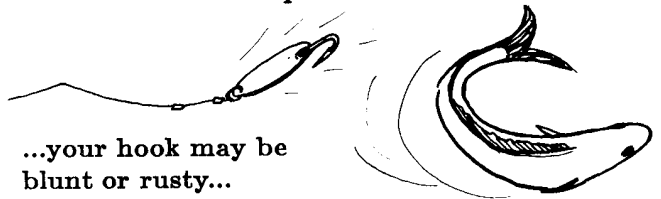

...your hook may be blunt or rusty...

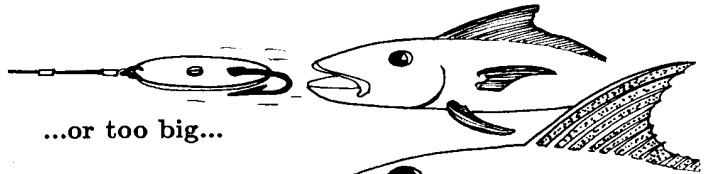

...or too big...



...or too small...

...so change it!

On some lures it's easy to change hooks...



...on some it's more difficult...

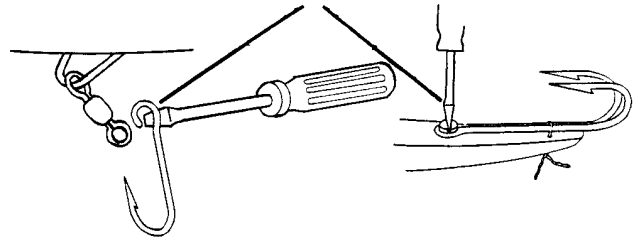

On some, special hooks are needed...

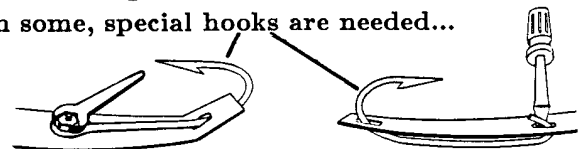

...and on some it's impossible

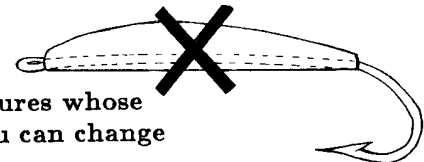

Stick to lures whose hooks you can change

Storage

Finally, make sure lures and traces are stored neatly in a dry place. If they are thrown haphazardly together, the traces and hooks will become tangled and some will get kinked or bent the next time it is necessary to try to get a lure out of the box. Coil traces up or, better still, wrap them around a large plastic bottle or similar item. The bigger the bottle or spool, the better it is for keeping your lines straight. If the lures are detachable, take them off the traces so that they will not get snagged or tangled.



Location: Niue Island

Photo: P.D. Mead

Coastal trolling using American snapper reels



Location: Upolu, Western Samoa

Photo: L.B. Chapman

Making a close pass by a FAD

TROLLING TECHNIQUE

- A. THE VARIETY OF TROLLING CONDITIONS -*Choice of fishing ground -Selection of gear
-Presenting the gear to the fish -The importance of experimenting*
- B. TROLLING THE LAGOON AND INSHORE WATERS -*Species Caught -Gear -Reef Patches*
- C. TROLLING THE OUTER REEF -*Species Caught -Gear -Passages -The reef edge -The drop-off*
- D. OPEN WATER TROLLING -*Species Caught -Gear -Ocean currents*
- E. TROLLING SURFACE TUNA SCHOOLS -*Locating a school -Species caught -Gear
-Fishing the school*
- F. TROLLING AROUND FISH AGGREGATION DEVICES -*Species caught -Gear -Fishing*
- G. SELECTING THE RIGHT BAITS AND LURES -*Local availability and cost -Trolling Speed
-Effectiveness for the target species*
- H. SELECTING THE RIGHT LINE -*Availability and cost -Strength -Vessel considerations
-Trolling depth -Detection by the fish*
- I. LINE LENGTH AND DEPTH -*Line length -Trolling depth*
- J. TROLLING TIMES -*Season -Day and night -Tides and moon phase -Weather*
- K. TROLLING SPEED -*Vessel considerations -Type of bait or lure -Type of line
-Fish preference -The human factor*

CHAPTER 5: TROLLING TECHNIQUE

SECTION A: THE VARIETY OF TROLLING CONDITIONS

There is no 'standard' way of trolling, and certainly no universal formula for success. So many things affect the troll fisherman's chances of fishing success that conditions change daily, or even faster. Many of these things are outside the fisherman's control -season, weather, moon and tides, the movement and behaviour of the fish, and so on. However, there are several things that the fisherman can influence -the location he chooses for trolling, the gear he chooses to use, and the way he presents his gear to the fish.

Choice of fishing grounds

Probably the most important choice the fisherman has to make is where to troll. Fish are not found evenly spread in the waters of the ocean, but occur in patches or groups which move in response to changes of season, weather, ocean conditions, and from day to night. In this chapter, we will consider the different types of fishing grounds the fisherman can choose between, and how they affect the selection and presentation of his gear.

Most fishermen have some choice about the type of area in which they will troll. In practice, the choice is limited by the local geography, prevailing weather and sea conditions, and things such as the capabilities of the boat. In some areas, there may be no lagoon, while in others the outer barrier reef may be too far distant for easy access, or may mean extended travelling times through less productive grounds in order to get there. Nevertheless, even with all the limitations in mind, at the start of the fishing day the fisherman still has to use his judgement in assessing the prevailing conditions and deciding whether and where to fish.

In this chapter we have tried to classify several reasonably distinct trolling environments. Each of these has different characteristics which the fisherman must recognise and account for in order to fish successfully. These environmental types discussed in the following sections are:

- lagoon and inshore areas (Section 5B)
- outer reef edge and offshore reefs (Section 5C)
- deep ocean waters (Section 5D)
- surface tuna schools (Section 5E)
- fish aggregation devices (Section 5F).

Selection of gear

The choice of fishing location is a major factor in determining the right type of fishing gear. However, several other factors also limit which lines, baits and lures the fisherman is able to use, and these are discussed in Sections 5G and 5H.

Presenting the gear to the fish

Once the gear is in the water, there are several further choices to be made regarding its presentation to the fish. Altering the trolling speed may make the bait more attractive to the fish, and will affect the way it 'swims'. Adjusting the line length changes the bait's position relative to the boat, and affects its overall pattern of movement. The depth at which the lure is trolled is important in the capture of some species, and can be altered by changing the trolling speed or the line length, by using different line materials, or by adding sinkers or diving devices. The factors which affect these choices are discussed in sections 5I and 5J.

The importance of experimenting

The tips and comments given in this section are based on observations about some types of fish at some locations in the Pacific at some times of day or year. They are not rules, because there are no rules for trolling. Like all fishing methods, trolling is a science, but not an exact science, and experimentation is the key word. You must keep trying new approaches in an effort to work out the combination of gear and fishing pattern that works for your boat on that particular day. Remain observant while on the water, try to notice things about local fishing conditions and the behaviour of the fish you are trying to catch, and take advantage of them. The biggest problem for a troll fisherman is laziness. You have to work at trolling, and the rewards are often in direct proportion to the amount of effort you put in.

TYPES OF TROLLING GROUND

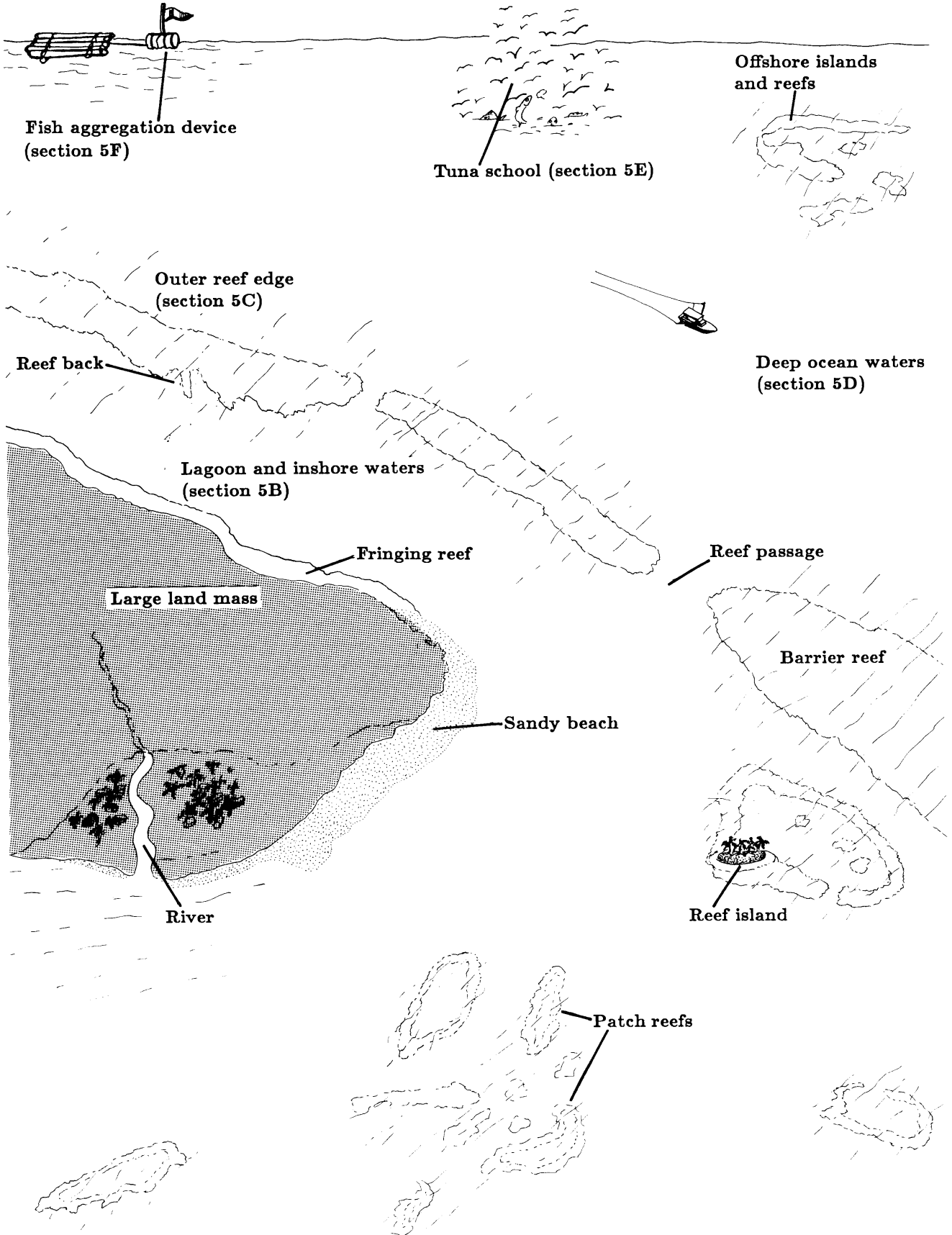

In most Pacific Islands, a coastal lagoon lies between the shore and the open sea, and the fisherman has to spend at least a short time trolling through this in order to reach other trolling grounds. Therefore, most fishermen usually carry out some lagoon trolling, even if this only means of half-heartedly towing a couple of lures while travelling.

The productivity of lagoon waters depends greatly on the size of the nearby land masses. Around the larger continental or high islands, lagoons are often very rich and may periodically abound in some large-sized migratory seasonal fish species, such as Spanish mackerels. Where the islands are small or low lying, the lagoon is often less rich, and large fish may be rare. In all situations, however, lagoon trolling (especially around reef patches, or close inside the barrier reef) produces its share of smaller fish and is a very important source of good trolling baits.

TWO DIFFERENT LAGOON TYPES

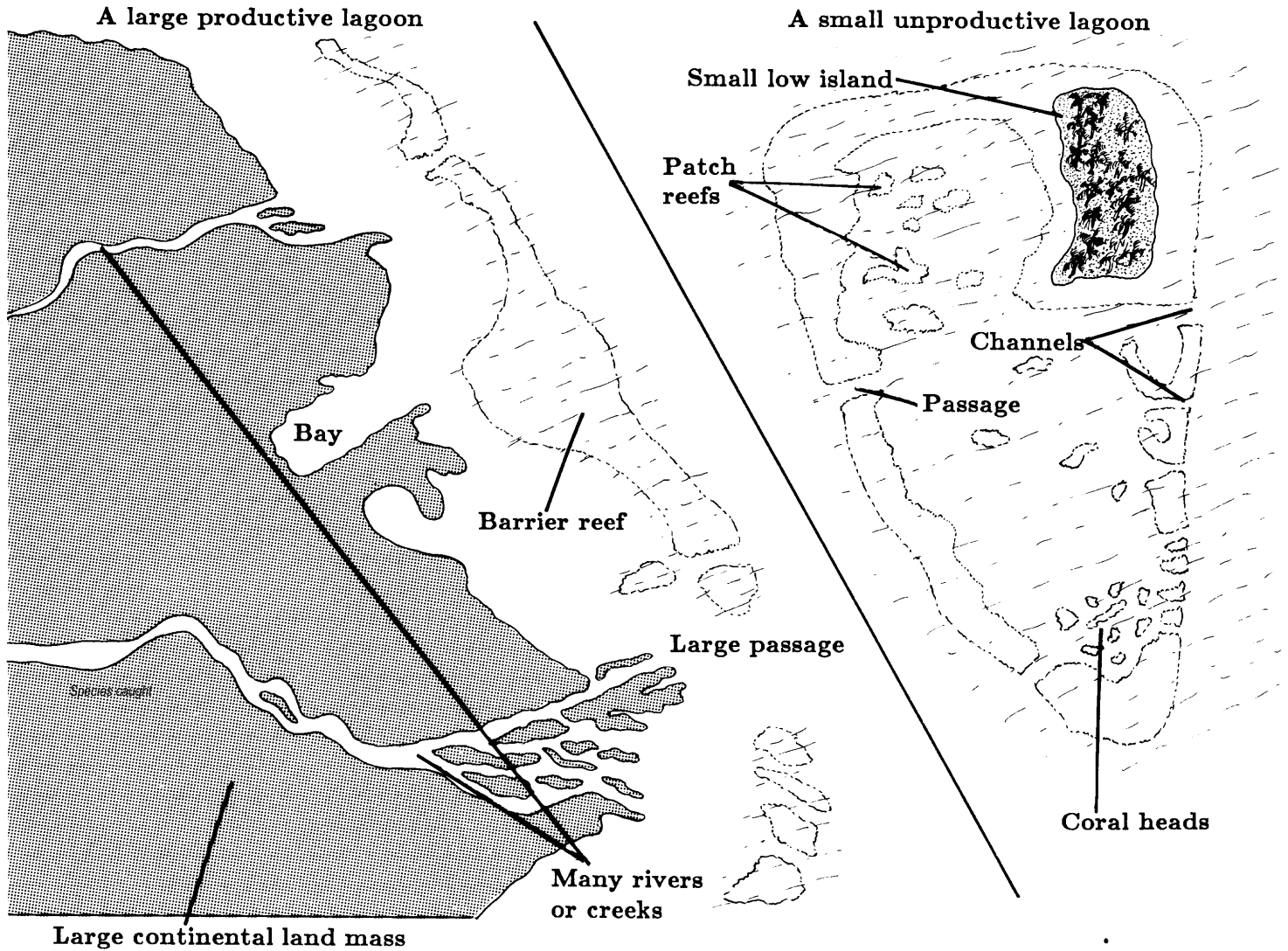

SOME OF THE FISH CAUGHT

Species caught

These will vary depending on lagoon type and geographical position. Larger, seasonally abundant Spanish mackerels occur in some of the large lagoons in the Western Pacific. Otherwise, typical lagoon species include barracudas, shark mackerel, mackerel tuna, trevallies, and diverse other species such as groupers and rock cods, wolf herrings, etc. The size is generally quite small, typically under 5 kg (11 lb). Many of these smaller fish make good bait when trolling for larger species.

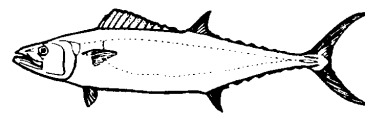

Double-lined mackerel

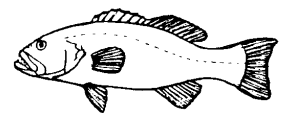

Groupers

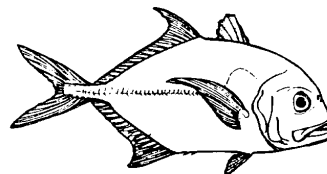

Trevallies

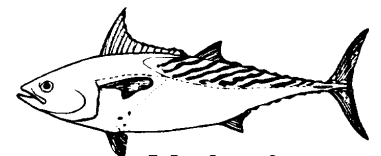

Mackerel tuna

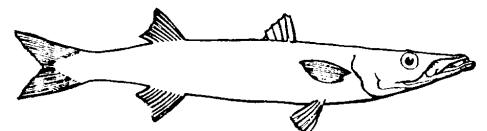

Seapike

Gear

Because of the generally smaller size of the fish, fairly light gear can be used for lagoon trolling. Small octopus or other types of lures, particularly Hashing spinners or spoons, are suitable, and these should be rigged on light wire (not nylon) traces. Natural baits can be used if you expect to catch Spanish mackerel or other large fish. Otherwise, they are probably not worth using, because there is a good chance that the fish you catch may not be very much larger than your bait. As many fishermen rely on lagoon trolling to catch much of their bait for other types of fishing, they would obviously use lures in an attempt to save their bait.

GEAR

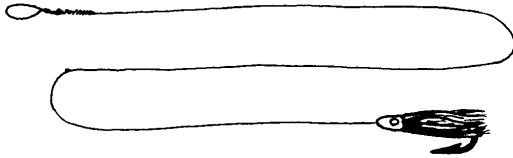

Use small lures on light wire traces for general lagoon trolling

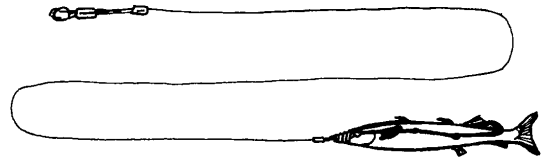

Use larger lures or baits on heavier wire or cable traces for Spanish mackerel

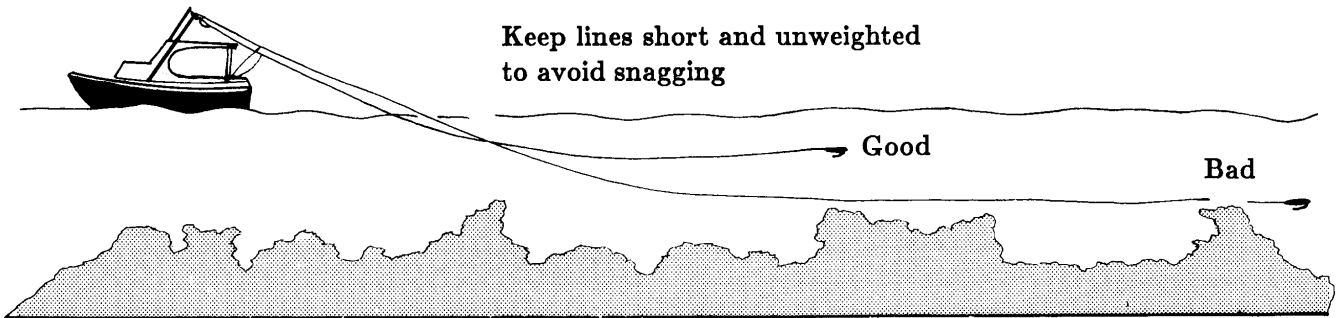

Keep lines short and unweighted to avoid snagging

Unless you know the area well, it is best to use unweighted lines to avoid the risk of hooking up on the bottom in areas where the lagoon may be shallow. For the same reason, lines should normally be kept fairly short -under 25 m (85 feet) so that they will not tangle if the boat has to turn sharply to avoid reefs or rocks.

REEF PATCHES

Reef patches

When lagoon trolling, make a point of passing reef patches or coral heads fairly closely where it is safe to do so. Many lagoon predators are somewhat territorial and will not stray too far from the coral patches which are their homes. Others are more wide-ranging but do much of their hunting around the patches where smaller fish often shelter. Hence, these tend to be good trolling areas and many strikes occur close to reef patches or outcrops. The windward side of a reef patch often produces more action than the lee side.

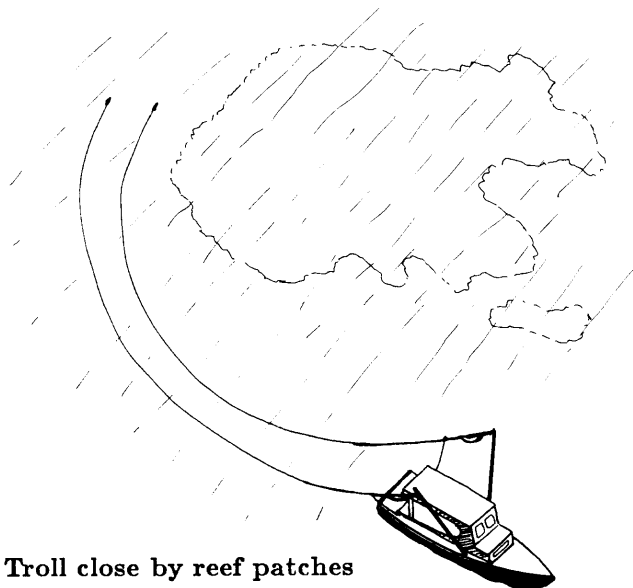

Troll close by reef patches when safe to do so

The waters just outside the outer barrier reef, or around offshore reef patches, are usually prime trolling grounds. These areas are the habitat of many predatory fish which feed on smaller reef-associated species, and grow to large adult sizes.

THE OUTER REEF ZONE

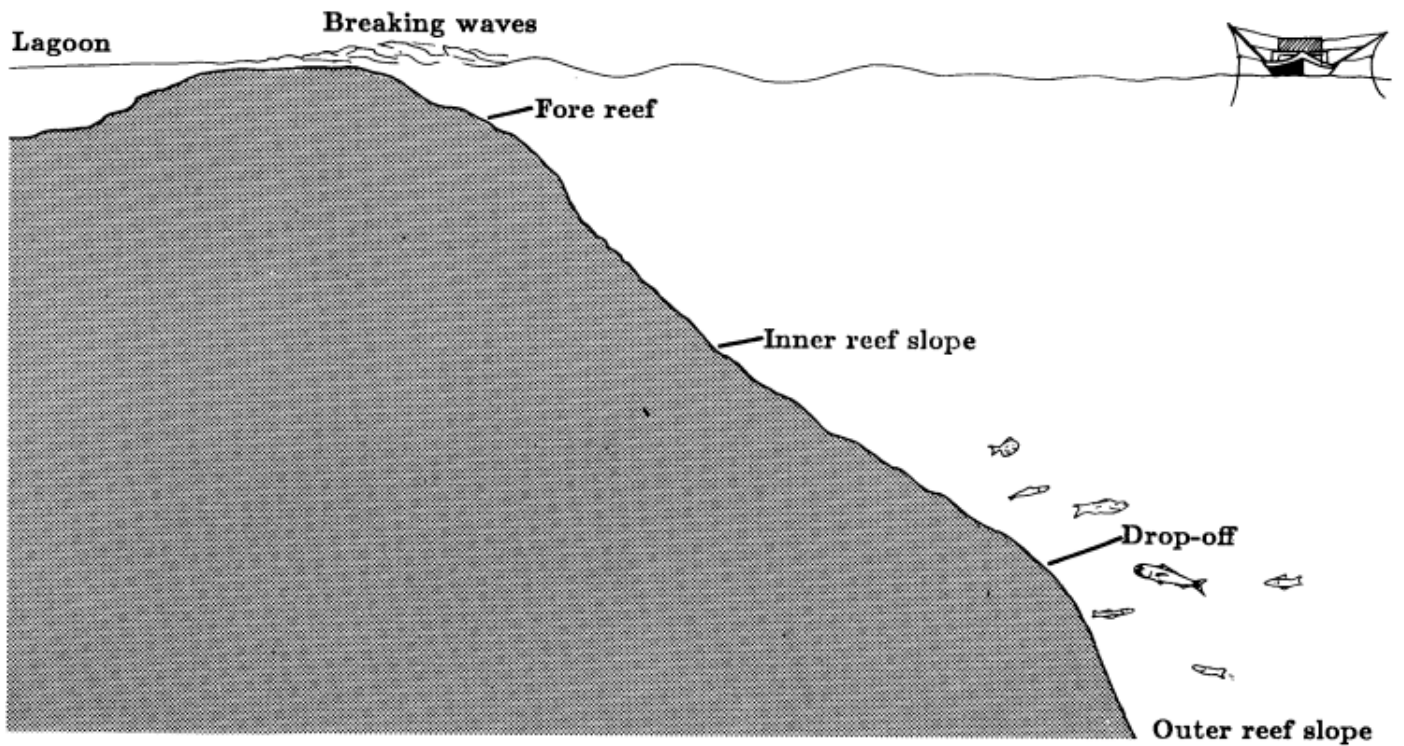

Species caught

The range of fish caught in this environment is variable, and includes the larger barracudas, yellowfin, bigeye and dogtooth tunas, trevallies, green jobfish, and coral trouts. In areas where they occur, Spanish mackerels will be caught in season, and are often larger individuals than those taken in the lagoon.

SOME OF THE FISH CAUGHT

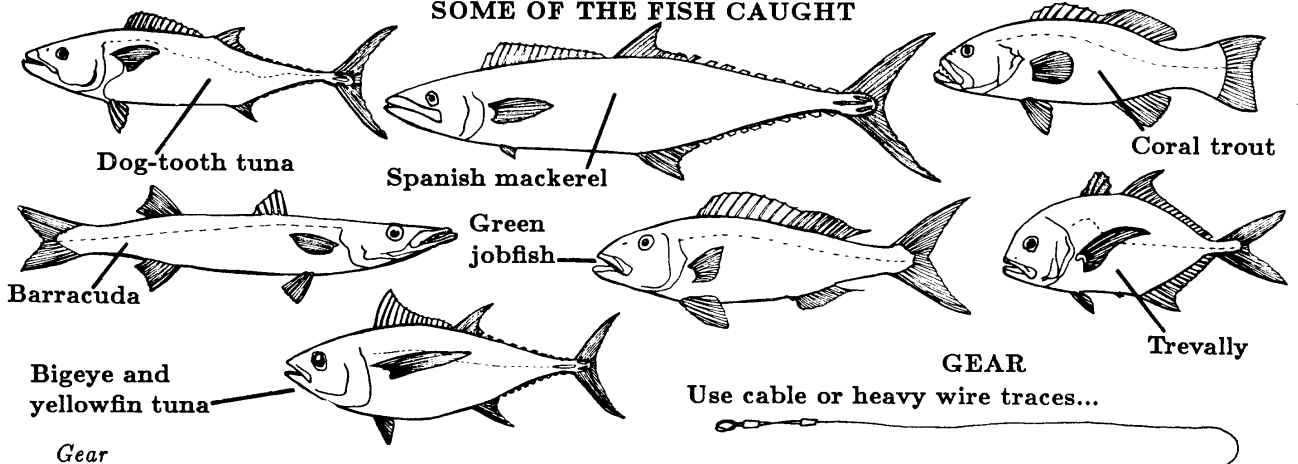

GEAR

Use cable or heavy wire traces...



...with natural baits...

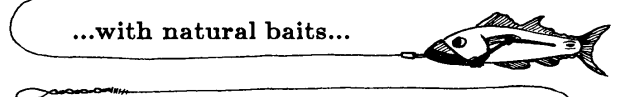

...or medium-sized lures

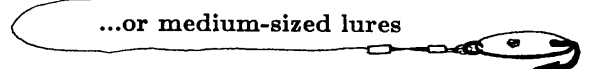

Sinkers may be useful for trolling drop-off



Because this area tends to produce good-sized fish (typically 5 to 50 kgs, or 11 to 55lbs), fairly heavy trolling gear should be used. This is a good area to troll at low speeds using natural baits, which should be rigged on cable or strong wire traces. Alternatively, fairly large-sized hard lures (spoons or Smiths jigs) or large octopus lures may be effective. Weighting the lines when trolling the drop off (see facing page) will often increase the number of strikes.

Passages

Passages, or breaks in the barrier reef, are usually good places to troll. The strong currents found in these areas attract feeding fish of many sorts, and it is usually worth making several passes through these areas, or circling around, in the hope of a strike.

THE REEF EDGE

Keep lines short and unweighted to avoid snagging

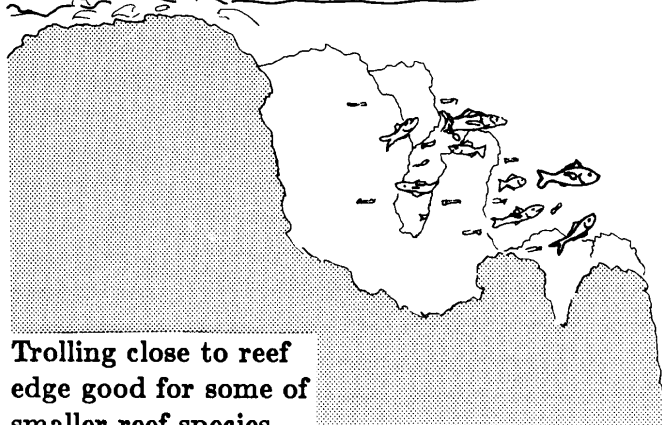
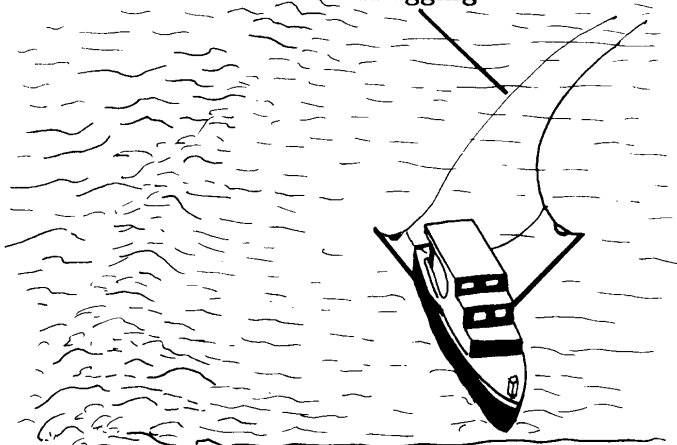

Trolling close to reef edge good for some of smaller reef species

The drop-off

Another reef trolling technique is to follow the dropoff, which is where the reef starts to fall away very steeply, often at a depth of 25 to 50 metres (85 to 170 feet). This is a good area for Spanish mackerel, wahoo, and other large reef-associated fish.

If the bottom is not visible, the drop-off can usually be distinguished by the colour of the water: a green or milky blue above the drop-off, and a clearer or ocean blue beyond it. By keeping one colour on one side of the boat and one on the other, it is possible to troll the drop-off contour quite accurately.

Since less sudden manoeuvring is normally required in this zone, lines can be made longer and weights or diving devices used to troll deeper.

PASSAGES

Work reef passages or breaks thoroughly

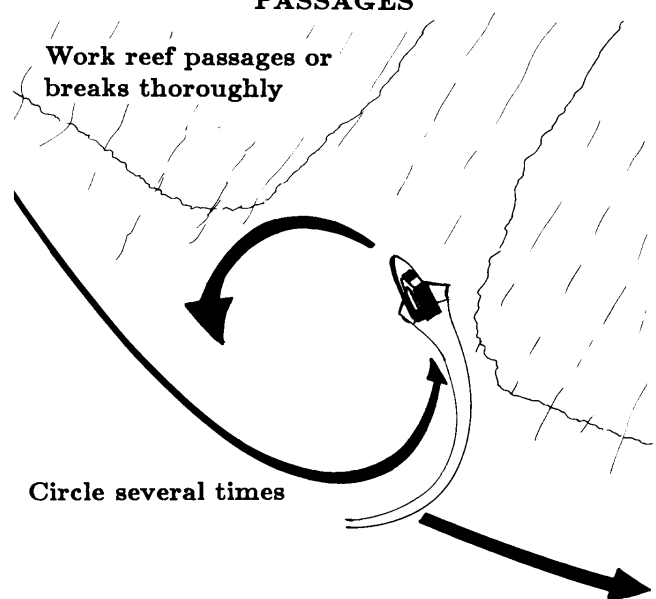

Circle several times

The reef edge

The face of the outer reef, or the line of breaking waves, is usually very distinct. Many fishermen like to troll parallel to it, at a safe distance, in water where the bottom is visible. This is a good area for catching smaller fish. Since there are often coral outcrops or cuts in this zone, the boat will need to manoeuvre quite a lot, so the lines should be kept fairly short, and should be unweighted to prevent tangles and hook ups on the sea bed.

THE DROP-OFF

If bottom cannot be seen use water colour to follow the drop-off

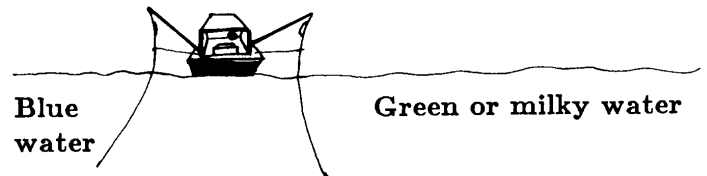

No danger of hooking bottom, so lines can be trolled deeper

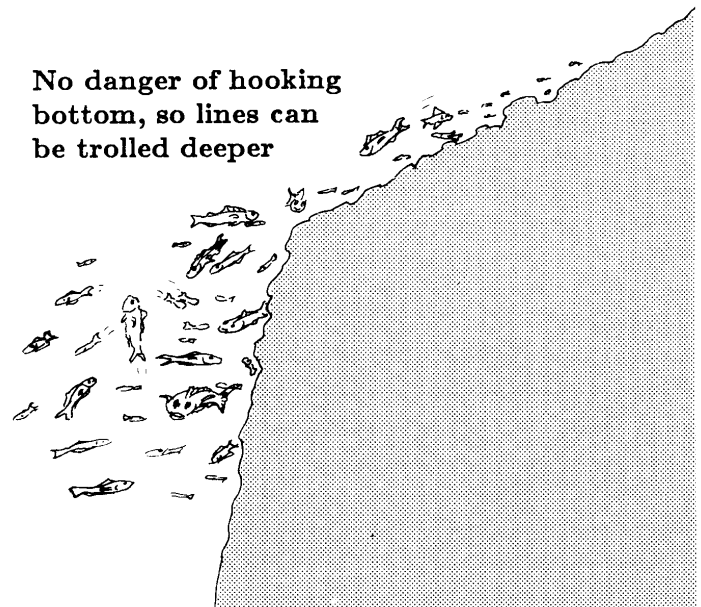

The deep ocean waters some way off the outer reef are probably the most difficult trolling grounds. The fish tend to be thinly scattered and hard to locate, and seem more wary about striking the gear than many inshore species. However, many fish in this zone grow to enormous sizes, so a single fish can represent a good catch.

THE OPEN WATER ZONE

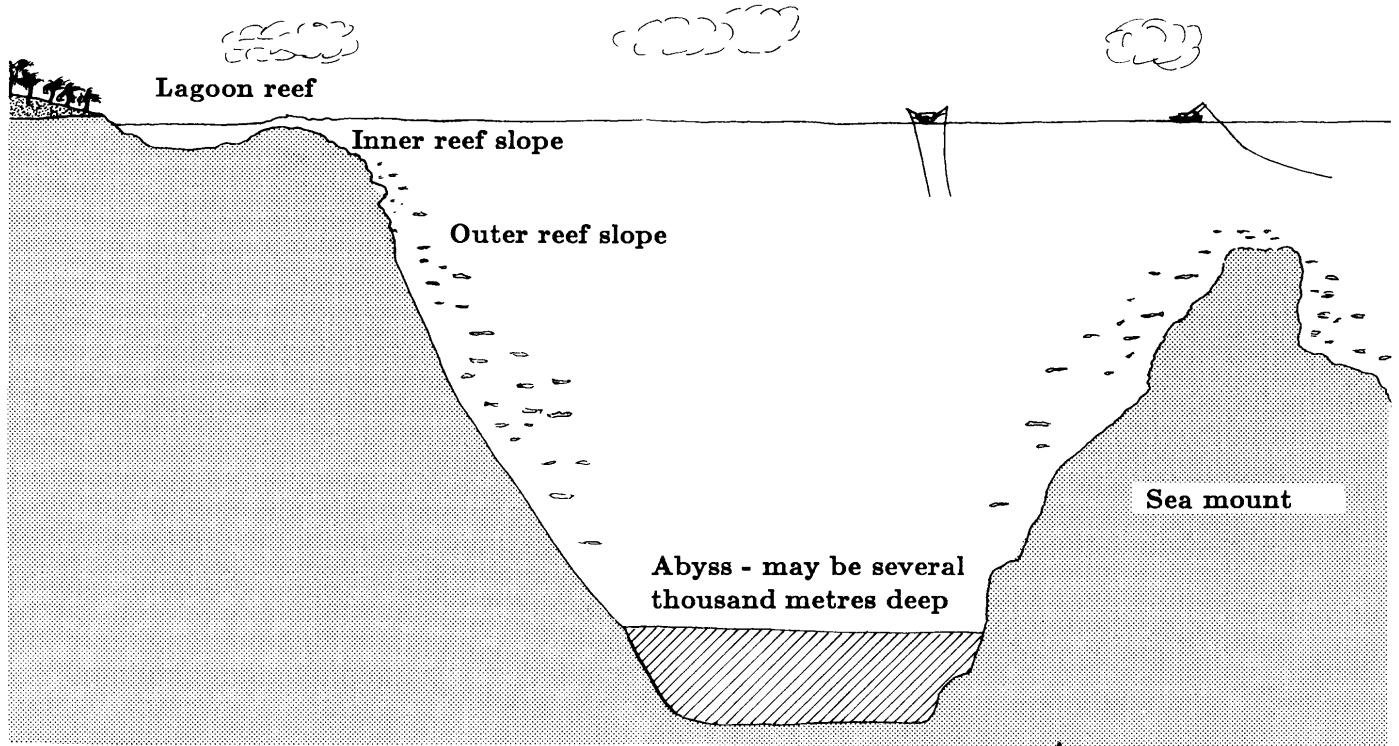

Species caught

This zone produces the fish sought after by big game fishermen -marlins, swordfish and sailfish -as well as wahoo, large yellowfin and bigeye tunas, and the large oceanic barracuda. Many surface schooling species may also be caught, but these are dealt with in Section 5E.

SOME OF THE FISH CAUGHT

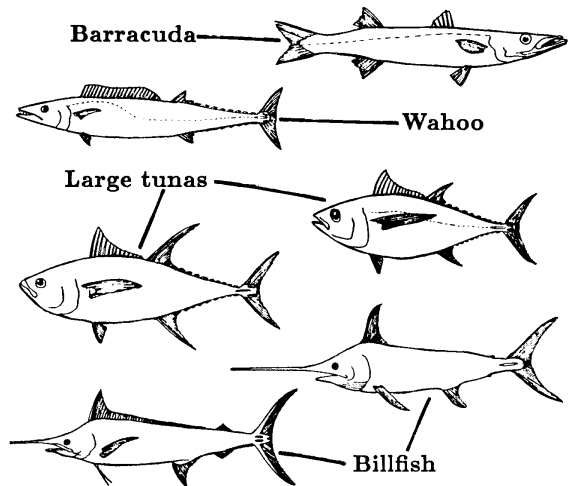

Gear

GEAR

Use heavy wire or cable traces...

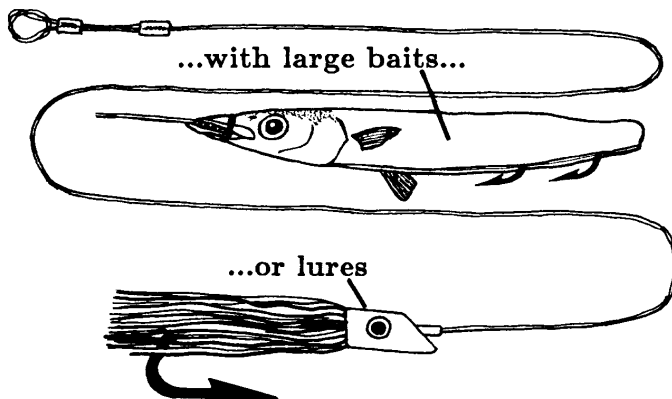

Use diving boards for deep-trolling

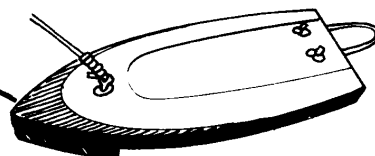

Because of the possibility of hooking large fish, this is the place to use your heaviest trolling gear. Large lures or good-sized natural baits rigged on heavy cable traces are often successful. There are few obstacles to the use of long lines which can be weighted or fitted with diving devices to carry the lures down deep. Sub-surface or deep trolling can be very effective in this zone. Handreels are much better than fixed lines for open water trolling, as they allow the larger fish to be played.

Ocean currents

Open water trolling can be a frustrating experience as the fish may be thinly distributed and hard to locate. Trolling 100-200 metres (350-650 feet) outside the dropoff (see Section 5C) is a good starting point to trolling in more open water.

However, knowing local current patterns increases the fisherman's ability to select good fishing grounds. Currents have a major influence on the behaviour of ocean fish through their effects on water temperature and food availability. A knowledge of local current patterns greatly increases the fisherman's ability to select good fishing grounds.

Places where currents meet, or where obstructions cause upwelling or turbulence, are often areas of high food productivity which serve as feeding grounds for ocean fish. Pronounced points on reefs often interrupt coastal currents, again creating conditions of upwelling where fish will often congregate. Likewise, underwater seamounts which rise sharply from the deep ocean floor cause current obstructions and have the same effect.

Ocean areas outside reef passages can also be good fishing spots, especially at times of spring tides when tidal currents through the passage are at their strongest.

Many types of fish are thought to swim against a current, so that they are constantly warned of what lies in their path by the odours and sounds that are carried towards them. Trolling with the current direction therefore increases the fisherman's chances of meeting more fish. After a strike, it may pay to reverse course and troll against the current in order to follow any fish that may have been travelling with the one that was caught.

OPEN WATER TROLLING

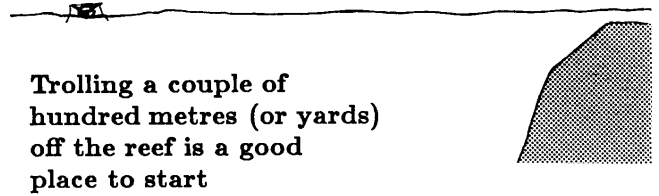

OCEAN CURRENTS

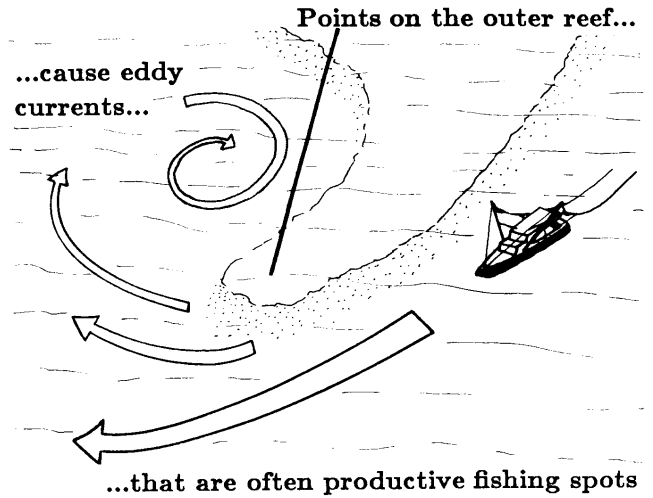

PASSAGES

Tidal currents lead to good fishing in areas outside reef passages...

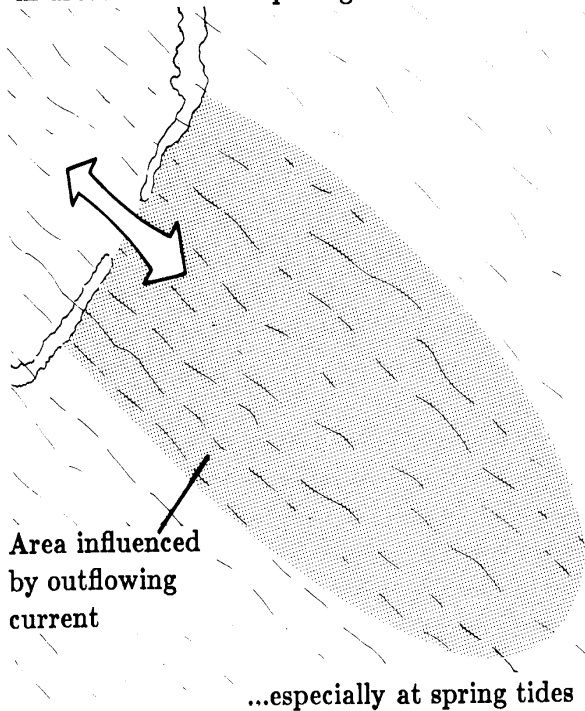

UPWELLING

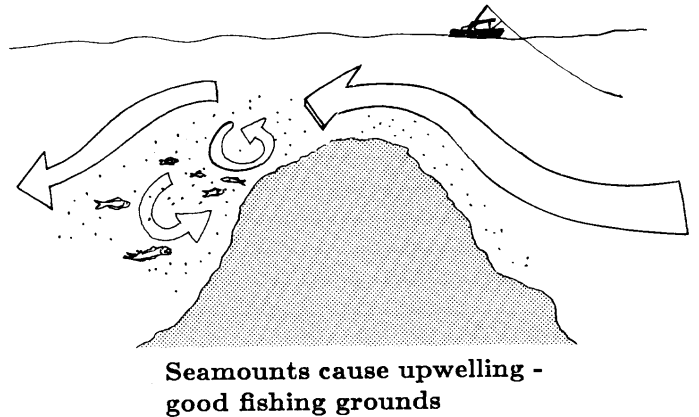

FISH BEHAVIOUR

Some types of fish swim against the current

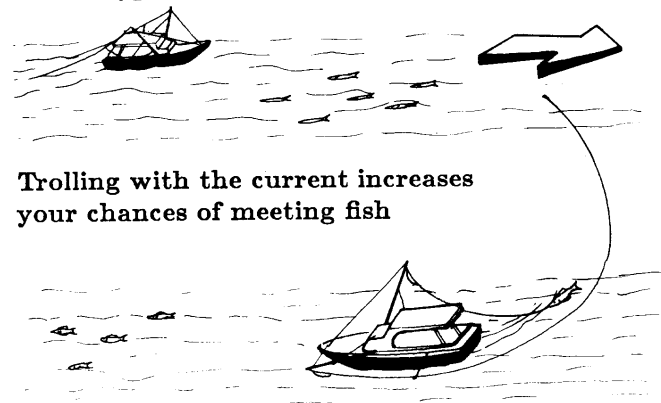

CHAPTER 5: TROLLING TECHNIQUE

SECTION E: TROLLING SURFACE TUNA SCHOOLS

Surface tuna schools are feeding aggregations of fish that occur within several miles of the coast in all Pacific Island countries for at least part of the year. They are usually, but not always, accompanied by *flocks* of seabirds which dive on the small bait fish driven to the surface by the feeding tuna. Schools may also be found in association with drifting logs, basking whales, or other floating objects. Trolling these schools is a specialist technique in its own right, as is the traditional Pacific Island fishing method of pole-trolling, which is described in Appendix 1.

LOCATING SURFACE TUNA SCHOOLS

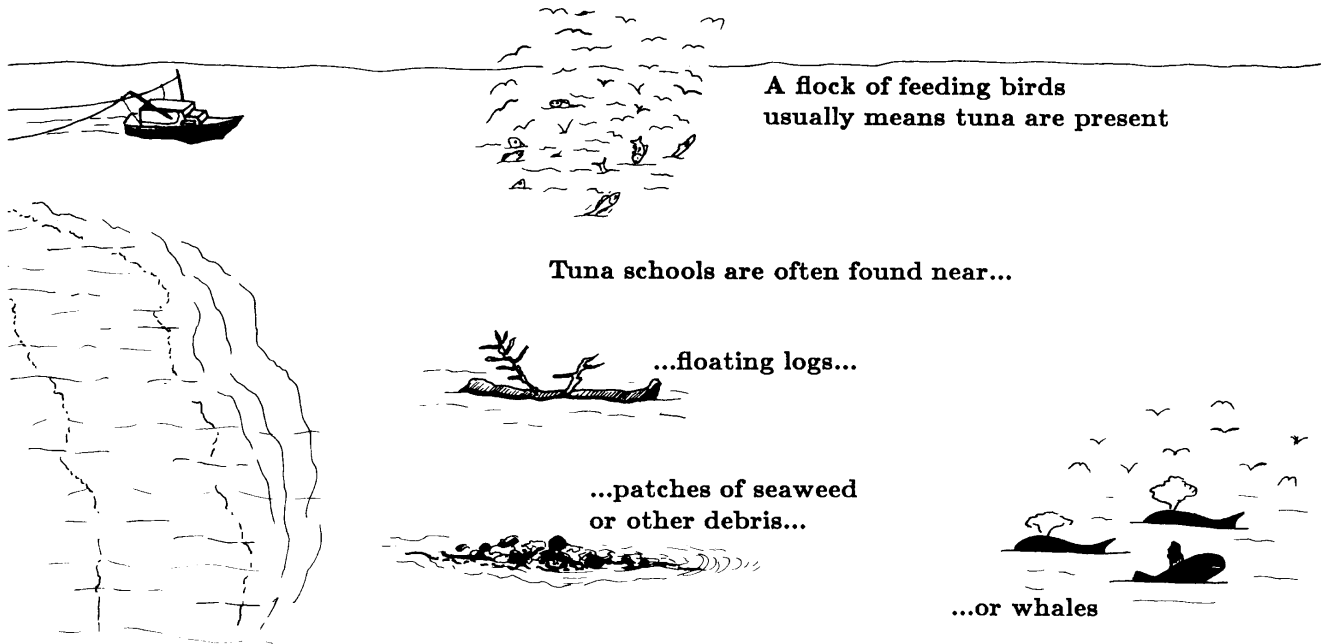

Locating a school

Schools are often located visually by searching for the flocks of birds usually associated with them. Other ways include searching for floating objects, (logs, patches of weed, and even whales) with which tuna schools are often associated, or checking locations where schools have been seen on previous days or weeks. Many schools can be found in the same location on successive days, or in places of favourable currents or other ocean features which regularly seem to attract them.

SOME OF THE SPECIES CAUGHT

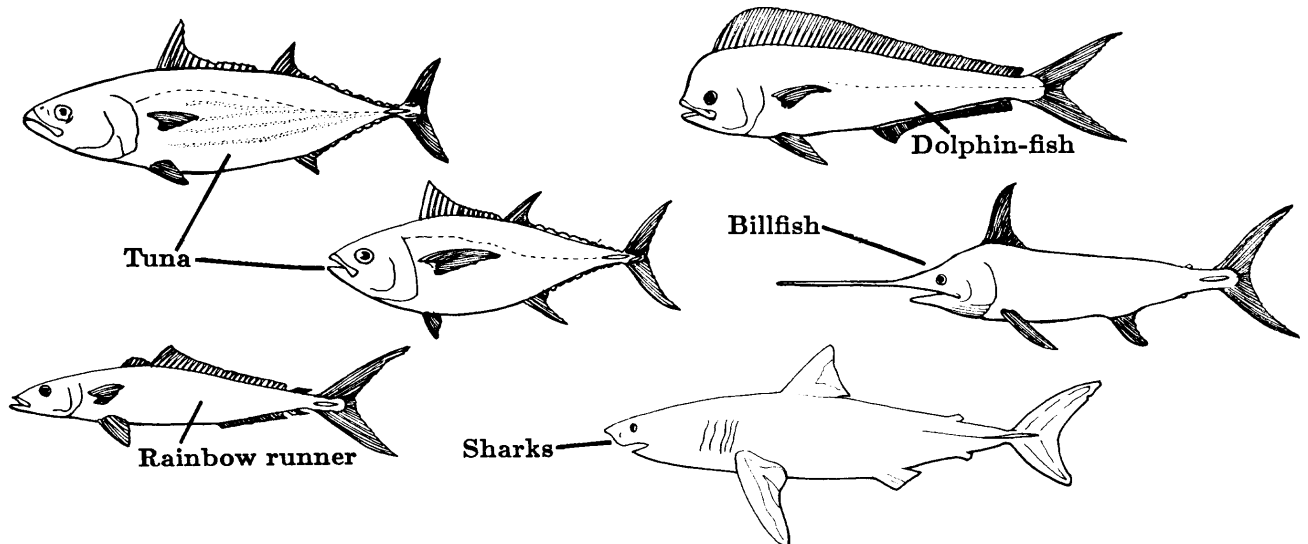

Caught

The schools contain varying proportions of skipjack, juvenile yellowfin and bigeye tunas, and associated species such as mahimahi and rainbow runner. The average size of the school fish is generally under 10 kg (22lb) and often under 5kg (11lb), but schools of much larger yellowfin occur from time to time. Small numbers of larger tunas are associated with many surface schools, often swimming deeper in the water than the main body of the school. A few large predators such as billfish and sharks are also usually associated with each school.

Gear

School tunas are usually of fairly small size so relatively light gear can be used. Since tunas are more or less toothless, nylon monofilament traces of 30 to 40 kg (65-90 lb) breaking strain can be used. These are preferred to wire or cable as tunas have very good eyesight and may be put off by a more visible trace.

Small octopus lures work very well in tuna schools, even when larger fish are present. Other types of small lure are also suitable. Natural baits are not generally used for this type of surface fishing, but can profitably be towed on a deeper line to pick up a larger, deeper swimming fish.

GEAR

Use small to medium size lures...

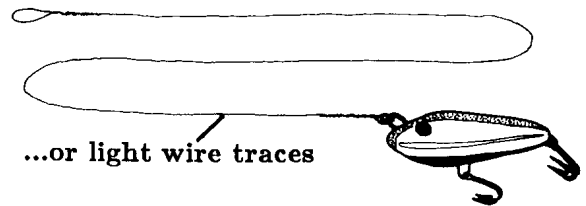
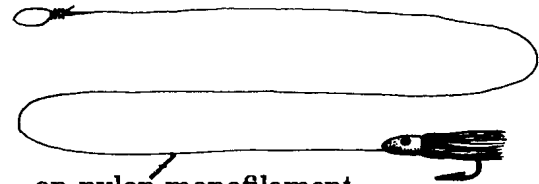

FISHING THE SCHOOL

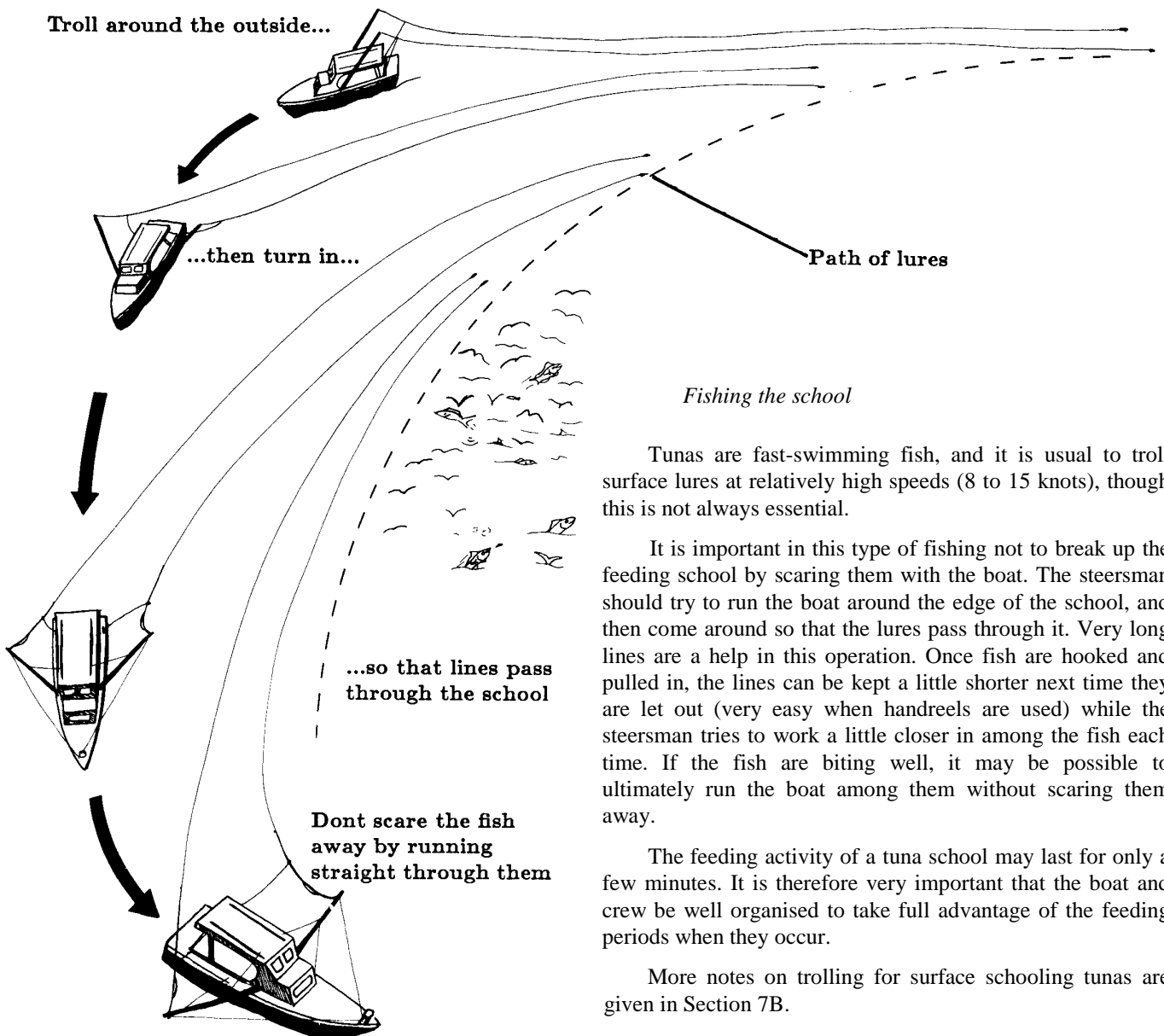

Tunas are fast-swimming fish, and it is usual to troll surface lures at relatively high speeds (8 to 15 knots), though this is not always essential.

It is important in this type of fishing not to break up the feeding school by scaring them with the boat. The steersman should try to run the boat around the edge of the school, and then come around so that the lures pass through it. Very long lines are a help in this operation. Once fish are hooked and pulled in, the lines can be kept a little shorter next time they are let out (very easy when handreels are used) while the steersman tries to work a little closer in among the fish each time. If the fish are biting well, it may be possible to ultimately run the boat among them without scaring them away.

The feeding activity of a tuna school may last for only a few minutes. It is therefore very important that the boat and crew be well organised to take full advantage of the feeding periods when they occur.

More notes on trolling for surface schooling tunas are given in Section 7B.

CHAPTER 5: TROLLING TECHNIQUE

SECTION F: TROLLING AROUND FISH AGGREGATION DEVICES

Fish aggregation devices (FADs) are a man-made alternative to the natural floating objects around which tuna schools are often found. Foam-filled oil drums or other objects are anchored in a known location in the hope that tuna schools will gather around them for the same reasons they gather around other floating objects -whatever those reasons may be.

FADs are not always 100 per cent effective, and have a tendency to disappear if the raft or mooring rope is damaged by bad weather, vandalism, or fish bite. Those which do work, however, provide many advantages to the small-scale fisherman. He spends less time and fuel in searching for fish, and the fact that his fishing location is known to those who might have to search for him in the event of a breakdown adds an important safety factor.

There are also some disadvantages to FADs, the main one being that a lot of fishermen may go out to fish the FAD at the same time, causing competition and interference in each other's fishing.

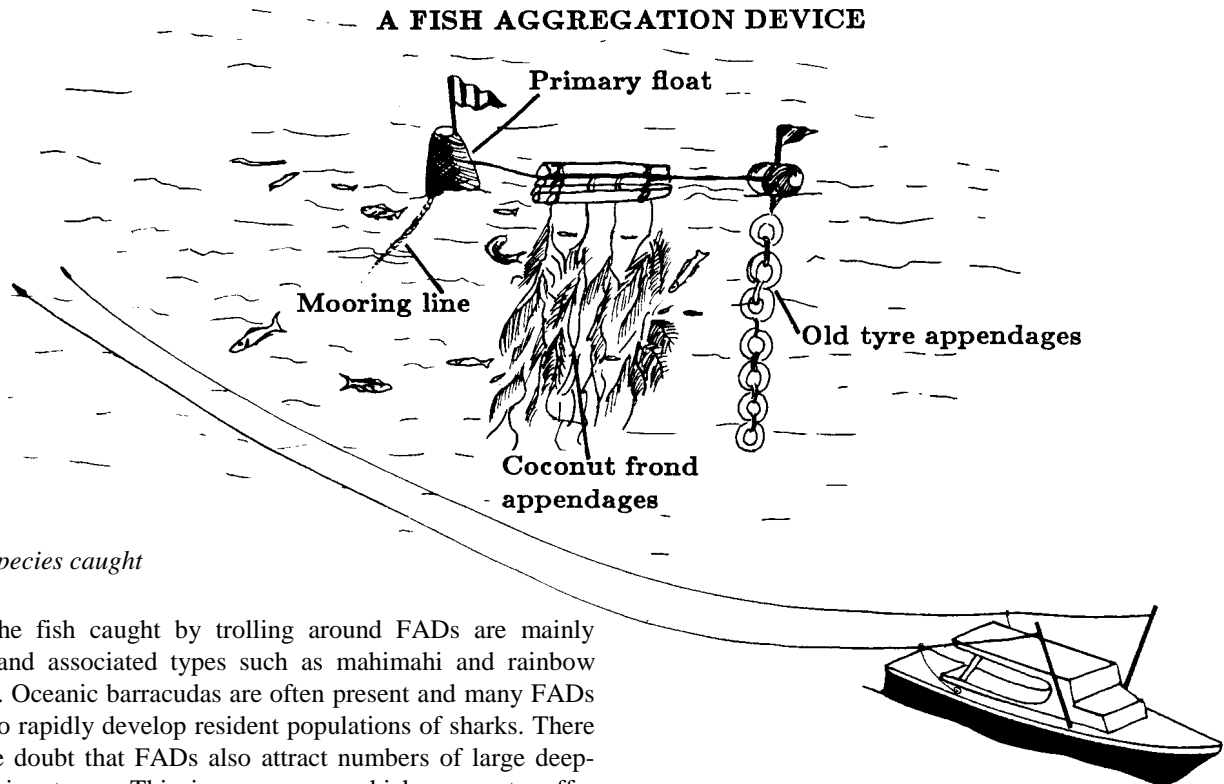

The fish caught by trolling around FADs are mainly tunas and associated types such as mahimahi and rainbow runner. Oceanic barracudas are often present and many FADs seem to rapidly develop resident populations of sharks. There is little doubt that FADs also attract numbers of large deep-swimming tunas, This is a resource which seems to offer potential for development by deepwater trolling and other fishing methods. At present, however, little is known about the most suitable trolling techniques for these deep-swimming fish.

SOME OF THE FISH CAUGHT

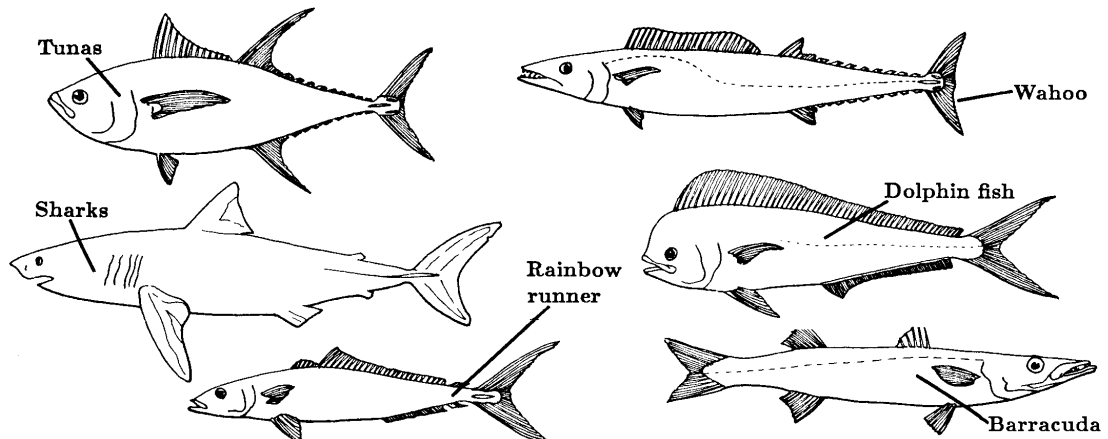

Gear

FAD fishing incorporates elements of both ocean or deep-water trolling (Section 5D), and trolling surface tuna schools (Section 5E). It is therefore necessary to be prepared for both these types of fishing -that is to have on board both heavy duty lines rigged with large lures or baits, and lighter lines rigged with small octopus or other lures. It will probably be necessary to change between one type of gear and the other during fishing.

Be prepared to use... GEAR

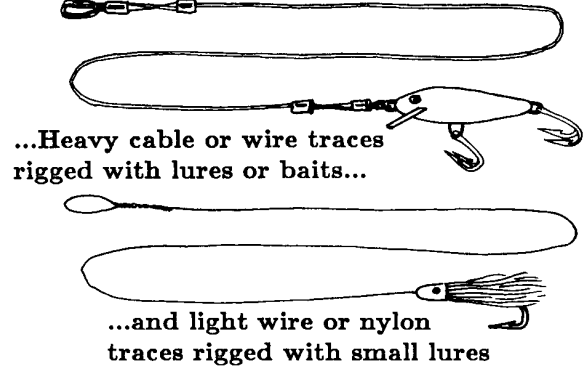

FISHING THE FAD

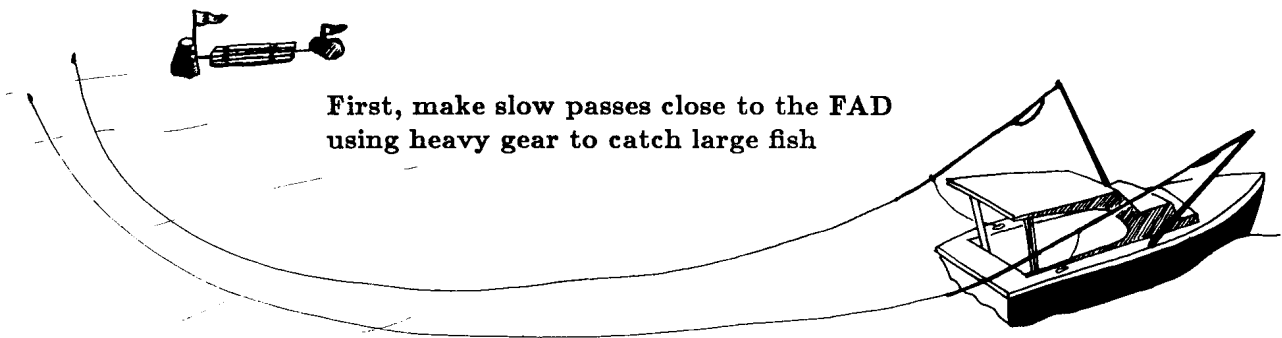

Then move further away and fish up-current side using lighter gear

Fishing

Having located the FAD, it usually pays to make the first approaches trolling fairly slowly, using heavier gear and passing as close to the FAD as possible without hooking it. Mahimahi, barracuda, and sometimes large yellowfin are often the first fish to hit, and the first to go off the bite. When this happens, change over to lighter lines and smaller lures, trolling a little faster for the smaller tunas. It may ultimately be necessary to change to monofilament traces if the fish are not biting eagerly.

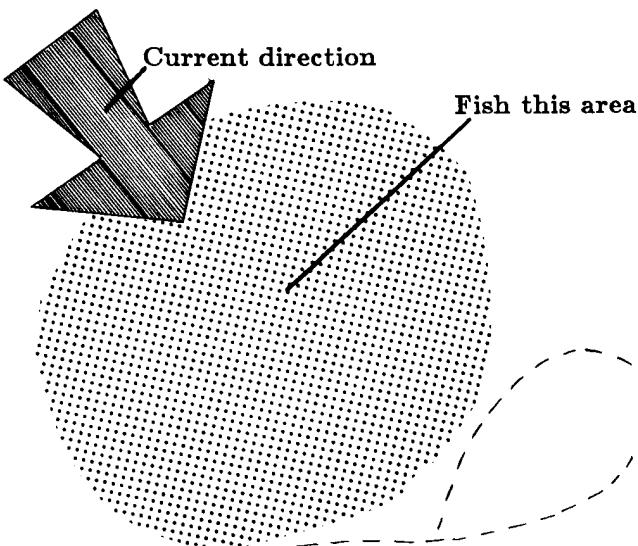

A consistent feature observed by FAD fishermen is that the majority of fish caught around FADs are taken on the up-current side. It is therefore probably worthwhile to devote more time to trolling in this area. To tell which side is up-current, pass close to the FAD to see which way the anchor rope or appendages are lying.

Flocks of birds may be feeding around the FAD, and these usually indicate tuna schools feeding on the same spot. Fishing for these is exactly as described in Section 5E.

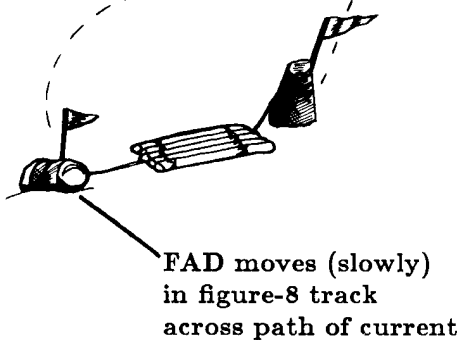

TO CHECK CURRENT DIRECTION

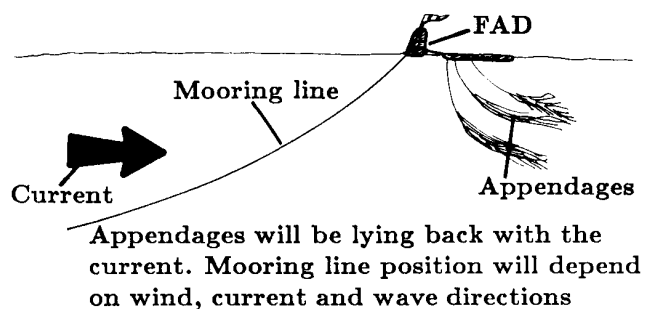

CHAPTER 5: TROLLING TECHNIQUE

SECTION G: SELECTING THE RIGHT BAITS AND LURES

In choosing his lures and baits, the fisherman's main aim is to select those he thinks are most likely to be attacked by the fish he wants to catch. However, in practice many other things will also affect the final choice.

NATURAL BAITS OR LURES

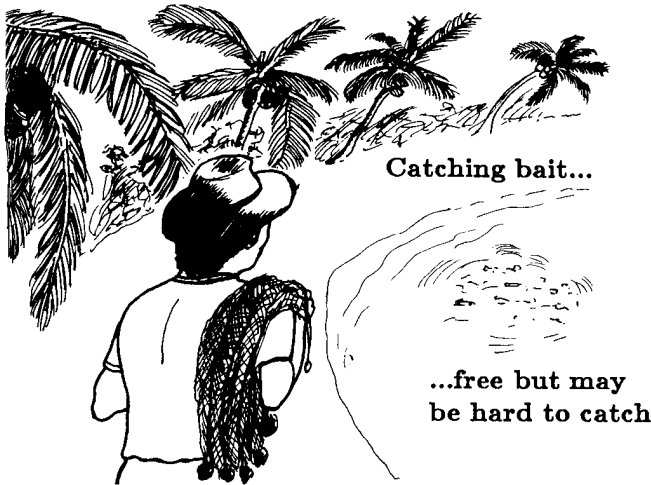

Local availability and cost

In many locations, the fisherman can use natural baits that he himself has caught. This costs him his time and labour but little or nothing in the way of cash. Alternatively he may be obliged to buy bait, thus adding considerably to his costs. Since bait availability tends to be variable, he may also have to store them (by freezing or salting) during times of abundance, further adding to his operating costs.

Artificial lures, on the other hand, require no special storage, and, although they sometimes appear very expensive to buy, they usually work out cheaper in the long run because they can be re-used. Unfortunately, in many Pacific Island locations, only a limited range of lures is available, and replacement hooks, skirts, etc. may be very difficult to obtain.

In practice, all this often means is that the fisherman uses natural baits when he can catch them himself, and artificial lures at other times.

In rural areas lures not available so no choice

Baits – usually work better, but they are perishable and slower to rig

Lures – more durable and only have to be rigged once, but may be less effective

Trolling speed

Most natural baits do not tow well at speed of more than 5 knots. On the other hand, many artificial lures can be towed much faster than this provided that the lines are weighted to keep the lures below the surface and stop them skipping. A few types, such as Kona lures and some diving lures, are designed to be towed at speeds of up to 20 knots. See Section 5K for more comments on trolling speed.

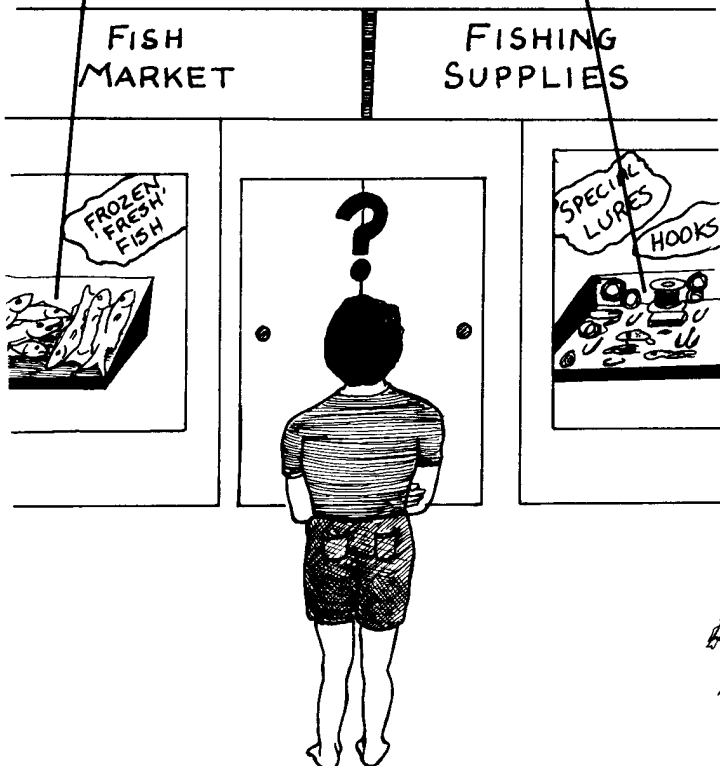

In town areas, may be able to buy both

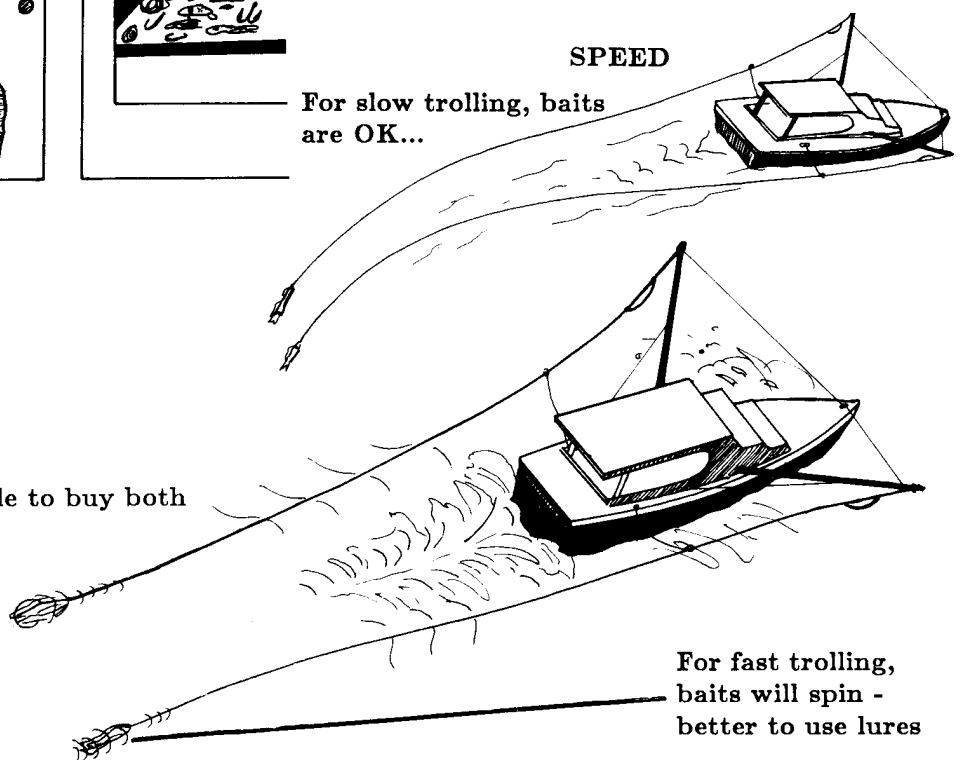

Effectiveness for the target species

Most fishermen agree that natural baits are generally more effective than artificial lures, especially on days when the fish are not biting well. In areas where the fishing is heavy, fish rapidly become 'educated' and are less likely to be tricked by an artificial lure. Larger fish tend to be more wary of lures than their younger brothers.

WHERE FISHING IS LIGHT

...and not many boats go trolling...



...lures will be OK

WHERE FISHING IS HEAVY

...and many boats go trolling...

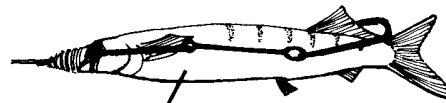

...baits usually better...

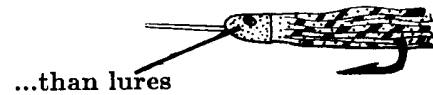

...than lures

However, when the fish are biting well, artificial lures will often out-fish natural baits. This is especially true when trolling on an actively feeding school of fish, which will snap at almost anything vaguely resembling the baitfish they are eating. In this case, using lures enables the lines to be got back into the water quickly after unhooking a fish. This type of frenzied feeding activity often lasts for just a few minutes, so the lines must be got back into the water as quickly as possible.

FISHING ON TUNA SCHOOLS

Fish bite madly but not for long...

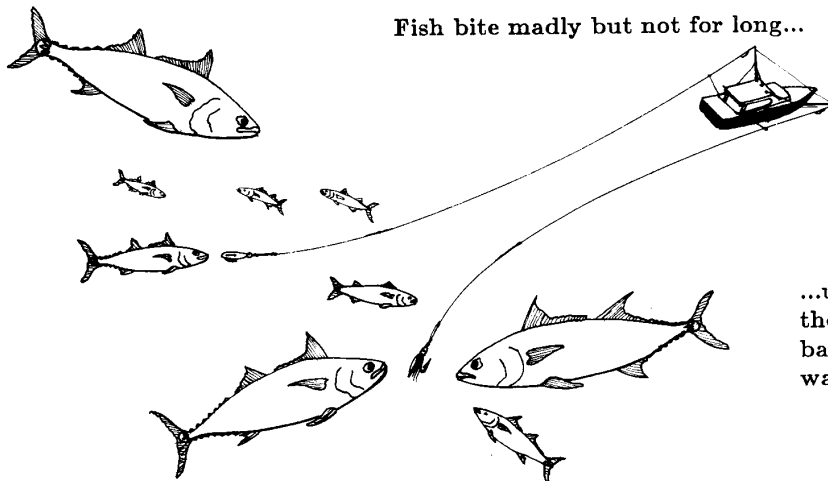

...use lures so they can be got back into the water quickly

CHAPTER 5: TROLLING TECHNIQUE

SECTION H: SELECTING THE RIGHT LINE

No combination of line materials is universally suitable for all trolling situations. The ultimate choice of which materials are used will depend on many factors, some of which are discussed here.

Availability and cost

Some materials may not be locally available, while others may be too expensive to justify their use. This is particularly true of braidlines, and of several types of cable, for which the fisherman also needs sleeves and crimping pliers to make joints. Nevertheless, choose carefully as buying good-quality gear can be an investment which will increase your catch and earnings.

Strength

Always make sure the line is strong enough. The resistance of the bait, plus the drag of the line itself in the water, can add up to a considerable force, especially when trolling at high speeds or when the line is long. The additional impact of a heavy fish striking at high speed against the direction of the pull can easily result in a broken line or straightened hooks.

AVAILABILITY AND COST



LINE STRENGTH

Fast trolling a large lure on a long line...



...produces a very heavy pull. The weight of a striking fish may break the line

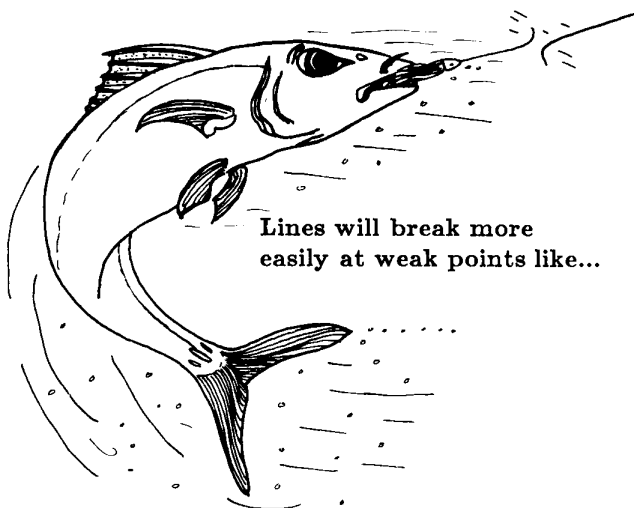

Breakage will usually occur at a knot, which can reduce the line strength by 25 to 50%, or at another weak point - a bend, kink, rust spot or wear point.

For these reasons, use oversized mainlines wherever practical. Stick to a minimum of 50 kg (110 lb) breaking strain and always use shock absorbers on fixed lines (see Section 3L).

...knots...

...kinks...

...wear points...

TRACES

Use wire or cable traces for fish with teeth

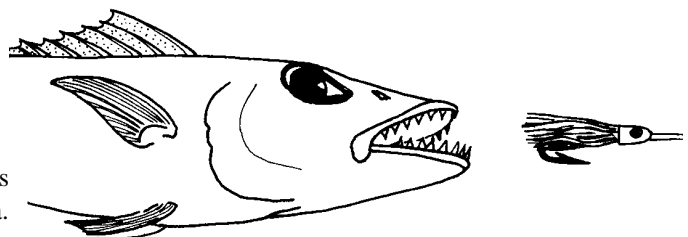

... so use oversize main lines when possible. Never use line less than 50kg breaking strain

Nylon monofilament or other types of non-metallic lines can be used for traces when trolling specifically for tuna. When catching other species, many of which have sharp teeth, wire or cable should be used to avoid the risk of the trace being cut.

Vessel considerations

If you troll using fixed lines (Section 31), most of the line materials available would be suitable for use in the mainline. However, if using handreels (Sections 3M and 3N), wires and cables will generally not be suitable as mainline materials, unless you modify the reels (and trolling booms, when necessary) by incorporating large diameter pulleys as line guides (see sections 2D and 2G).

VESSEL CONSIDERATIONS

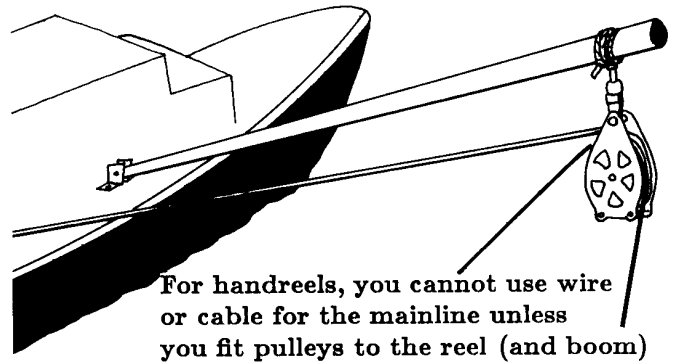
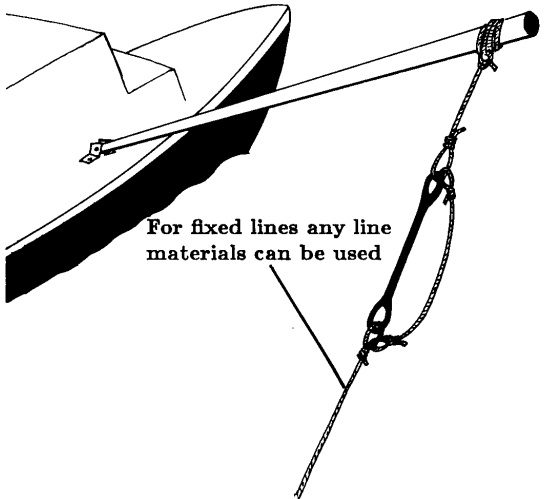

TROLLING DEPTH

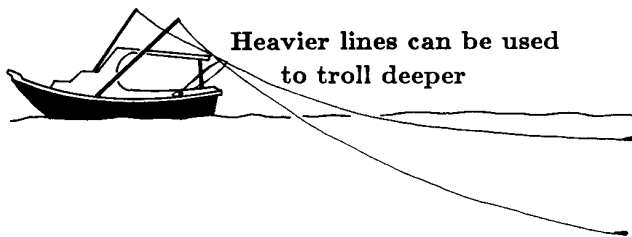

Trolling depth

To some degree, line materials can be used to alter the depth at which the lure is trolled, as shown in Sections 3J and 3K. At the same trolling speed and line length, the denser the mainline material, the deeper the line will fish. See Section 51 for more comments on trolling depth.

Detection by the fish

In general, the more visible the line is, the more likely it is to deter the fish from attacking the bait. Badly made knots, splices or crimped joints will cause turbulence which will divert the attention of the fish and warn him that there is something unusual about the bait. This consideration is much more important in areas of heavy fishing, where the fish are more wary, than in areas where fishing is light. It is also more important when trolling in clear waters for fish with very acute eyesight (e.g., tunas) than it is when fishing in clear coastal or lagoon areas.

LINE VISIBILITY

Lines should be as 'invisible' as possible...

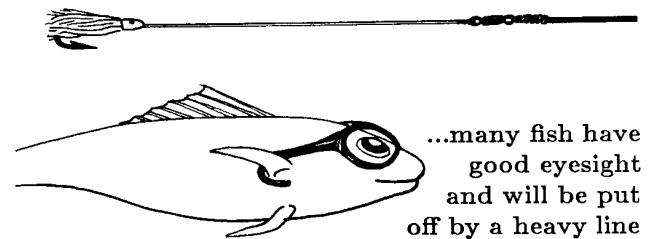

Badly made knots and joints may put off the fish by causing turbulence...

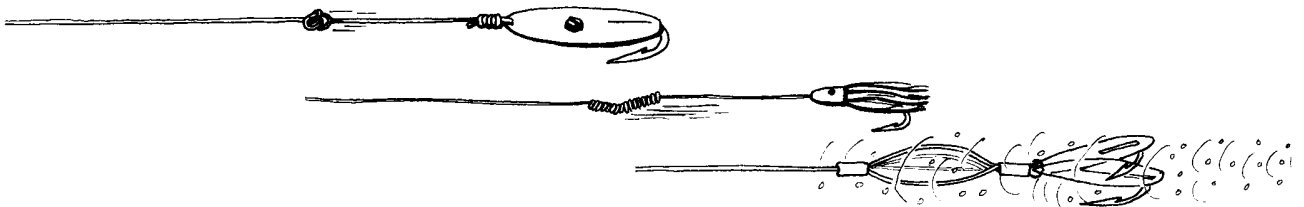

...or may unbalance the action of the lure

CHAPTER 5: TROLLING TECHNIQUE

SECTION I: LINE LENGTH AND DEPTH

As with the selection of gear (sections 5G and 5H) and of trolling speed (Section 5K), the final choice of line length and trolling depth depends on a number of things.

Line length

It is generally accepted that the bait should be trolled well back from the boat so that engine noise or the turbulence from the boat's wake will not disturb the fish. 30 -50 metres (100 -165 feet) is a good average line length, with many fishermen preferring much greater lengths, up to 150 metres (500 feet). However, there is no doubt that strikes will often occur right behind the boat, especially when hauling lures in. This is a characteristic of certain species of fish (e.g. Spanish mackerel and dolphin fish) or happens at times of very frenzied feeding activity.

In reef bound areas, where the boat is constantly manoeuvring, long lines can become tangled with each other. In this case, they should be kept short, down to a minimum of about 15 metres (50 feet).

If several fixed lines are being trolled, those on the outside need to be longer so that they can be hauled in without tangling on the inner lines. An outer line should be at least 10 metres (30 feet) longer than its inner neighbour.

If using handreels, adjust the line length as conditions dictate. With fixed lines, the lengths have to be decided in advance, so it is important to take account of the likely fishing conditions at this stage or to make up a number of lines of different lengths.

There is no rule that says that baits or lures have to remain the same distance from the boat throughout the day. If strikes are few and far between, try varying the distance until you find an arrangement that works.

LINE LENGTH

Area of boat turbulence

Lines should be long enough...

Trolling several fixed lines...

...so that baits or lures are well out of boat turbulence

Lures well back

...inner ones should be shorter

Outer lines - at least 10m (30 feet) longer than inner lines

TROLLING IN REEFY AREAS

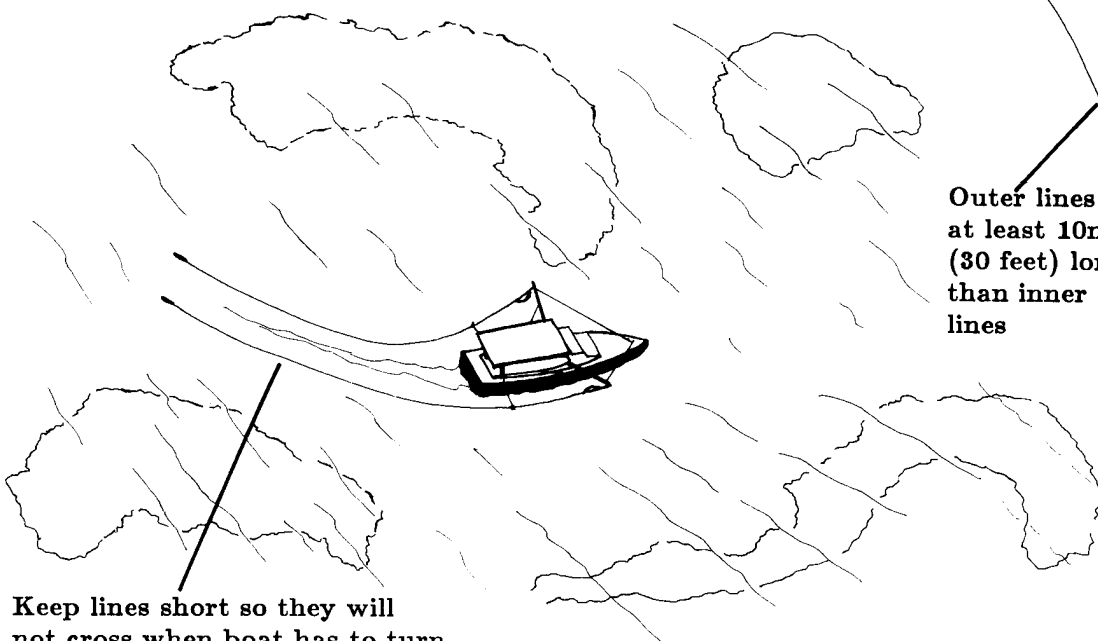

Trolling depth

When several lines are being towed, there is a good chance of them becoming tangled on a turn or when a fish strikes, especially if the lines are long. This problem can be partly avoided by rigging the lures to troll at different depths, thus reducing the chances of them interfering with each other. The inner lines should be arranged to fish deepest, by using weights or diving systems, such as those described in Sections 3J and 3K. The outer lines should troll at the surface, and, should be longer than the inner lines.

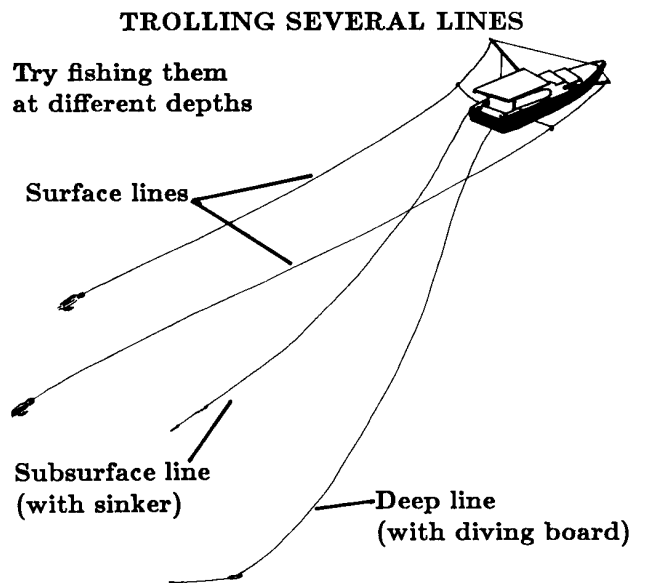

When trolling in shallow water or in areas where reef heads and patches are numerous, baits and lures trolled at any depth stand a good chance of hooking up on rocks or coral. Lines should therefore be trolled at the surface in these areas.

TROLLING IN REEFY AREAS

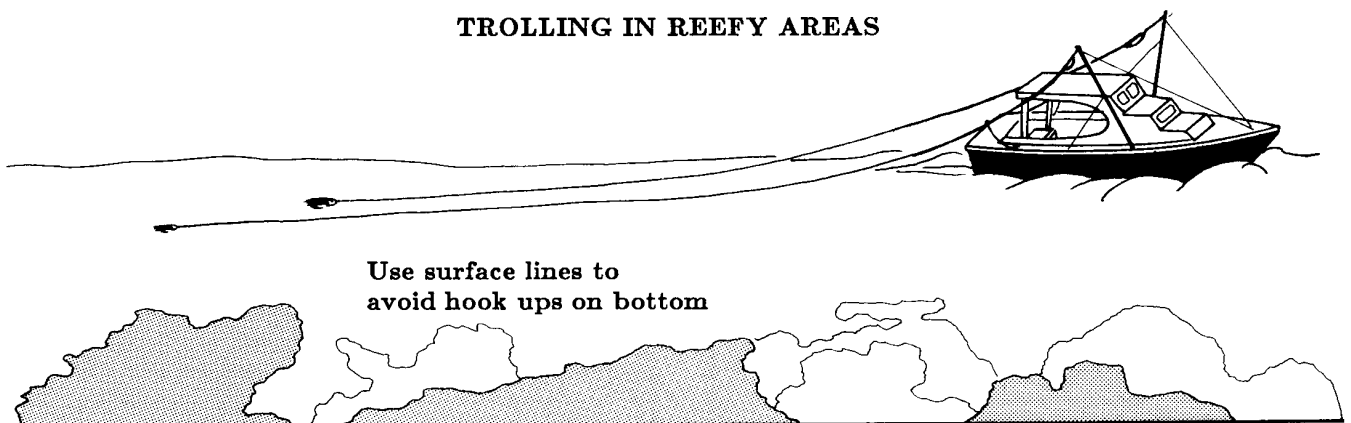

Adjusting the depth of the bait or lure increases its chances of being seen and attacked by different fish species. Larger, deep-swimming tunas can be taken by deep (more than 10 metres, or about 30 feet) or sub-surface (2 to 10 metres, or 6 to 30 feet) trolling. Reef-associated pelagic species will normally be caught on surface (less than 2 metres, or about 6 feet) and sub-surface lures. For trolling in the lagoon or on open-water tuna schools, surface lures are often the most effective.

DIFFERENT TROLLING DEPTHS...

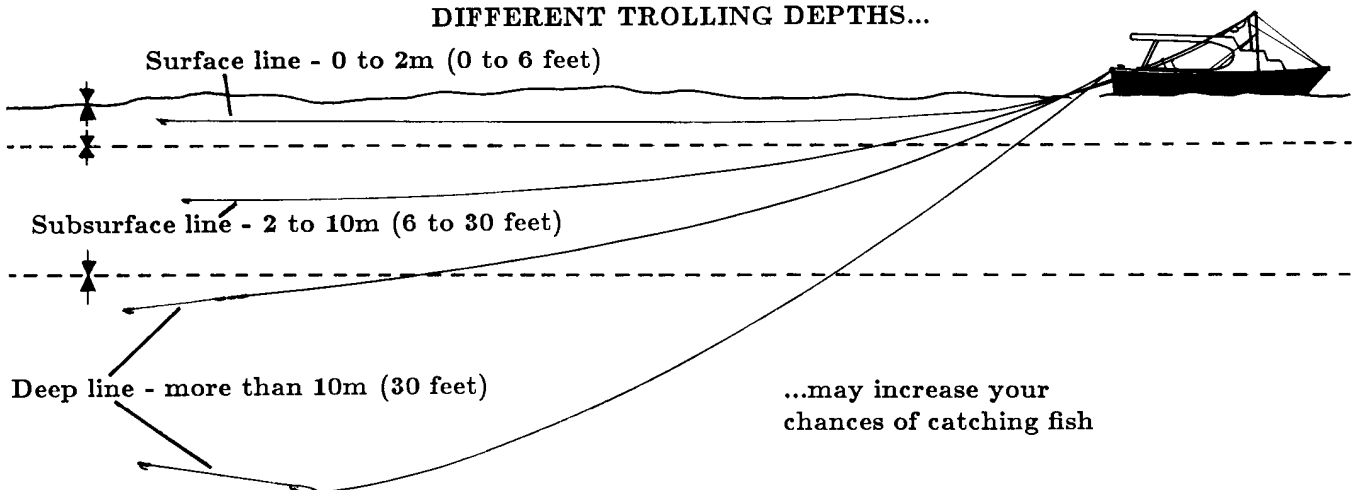

CHAPTER 5: TROLLING TECHNIQUE

SECTION J: TROLLING TIMES

The season of the year, moon phase and tides, and the time of day all have significant effects on trolling success.

Season

The season affects the abundance of migratory fish species, such as tunas and other oceanic species, and Spanish mackerels. In cooler countries these fish only appear during the warmer part of the year, for periods of a few months. Trolling for these species is much better during these periods than at other times of the year.

Day and night

Many fish follow a regular daily feeding pattern of feeding activity, usually feeding more intensively early in the morning, showing a declining interest in food during the day, but feeding again late in the afternoon or evening. Many reef or lagoon species, and some of the larger tunas, continue to feed through the night. For most fishermen, night-time trolling is too dangerous to be feasible, although there is some evidence that trolling on bright moonlight nights using reflective or luminous lures can be successful.

Tides and moon phase

The 'normal' day/night feeding pattern is modified extensively by the tides. When rising or high tides occur at dawn or dusk, trolling success will often be above average.

The moon phase affects fish abundance both by its effects on the tides, and because of the changing light conditions during the night as the moon waxes and wanes. Times of full or new moon, and the corresponding spring tides, are often periods of more active feeding among large predatory fish. Tidal currents are strongest at these times, and reef passages can be very good fishing grounds. Full moons draw many small, deep-living prey species to the sea surface at night-time, and this phenomenon tends to encourage the feeding activity of the types of fish normally caught by trolling.

MOONLIT NIGHTS

Light from full moon...

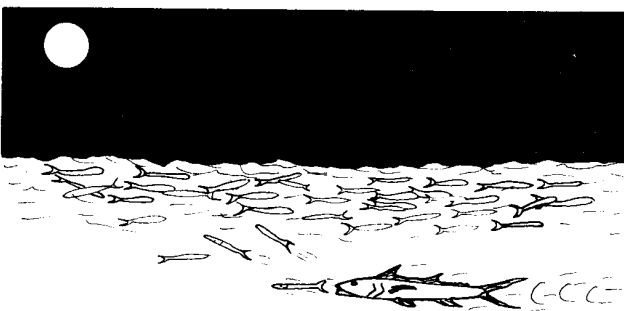

...draws baitfish to surface during night.
Improves trolling at dawn and dusk

SEASON

Many seasonal species...

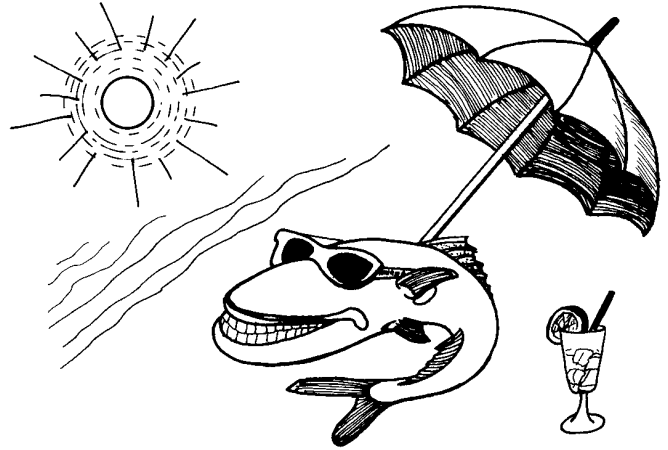

...only around in summer

TIME OF DAY

Best times are before dawn till 10 am...

...and 4 pm till after dark

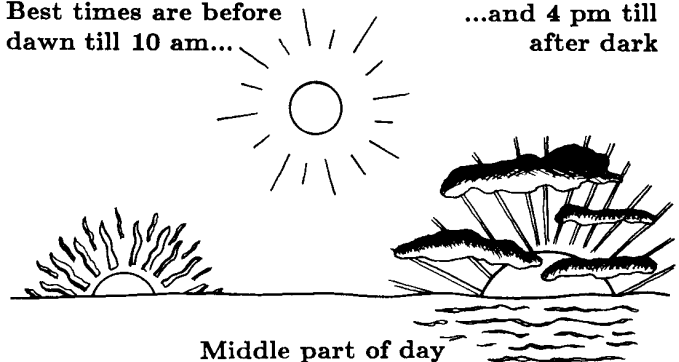

Middle part of day
not usually very good

TIDES AND MOON PHASE

Full moon and new moon...

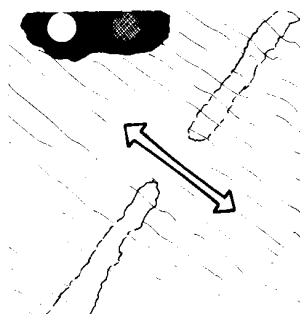

...strong tidal currents give good trolling

First and third quarters...

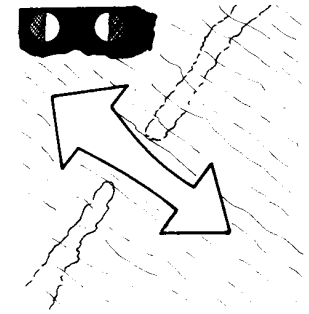

...weak tides, poorer trolling

Weather

Weather conditions affect both the fish and the fisherman. Clear, calm hot days can be good for trolling, and on these days the fisherman can use fairly small baits and lures, which the fish can see easily in the calm water. The best fishing days of all, however, are usually rainy and windy. At these times, use larger baits or lures that can be seen through the surface commotion.

WEATHER CONDITIONS

Clear, calm, hot days...

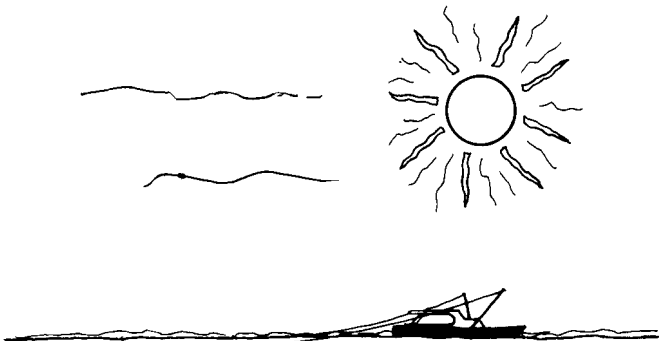

**...can be good for trolling.
Use small baits and lures**

Rainy, windy days...

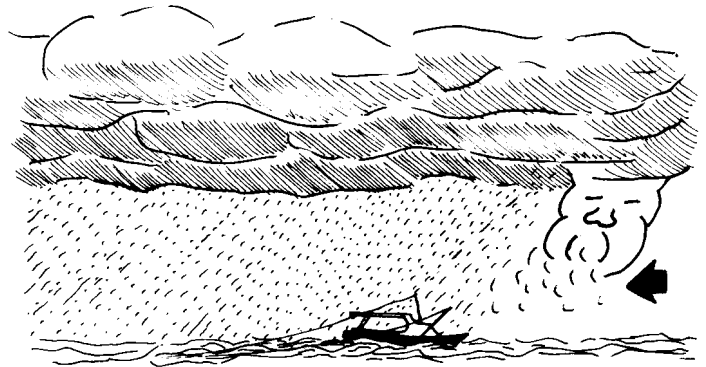

**...usually give the best fishing.
Use larger baits and lures**

When trolling in a beam wind, it is best to put your heaviest lures on the upwind side of the boat. This way there is less chance of the lines being pushed together or against the side of the boat by the wind.

TROLLING IN A BEAM WIND

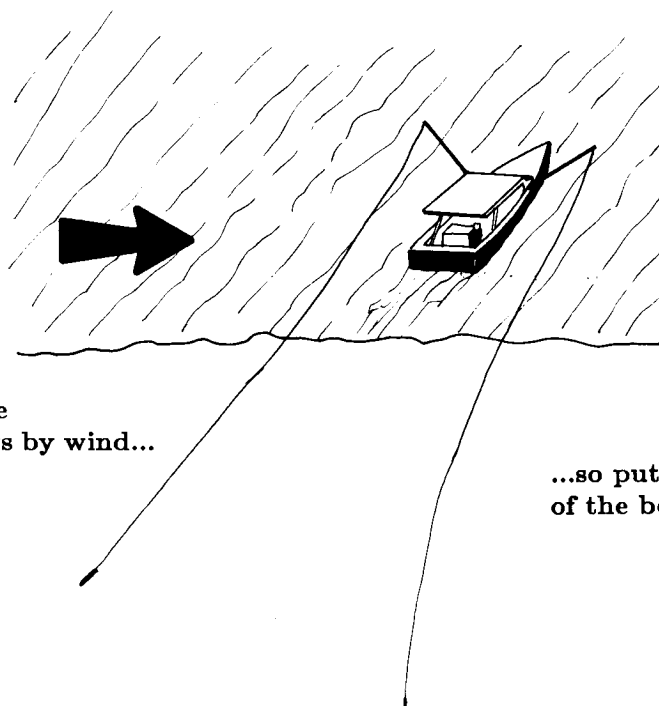

**Heaviest lures will be
least pushed sideways by wind...**

**...so put them on the upwind side
of the boat to avoid line tangles**

CHAPTER 5: TROLLING TECHNIQUE

SECTION K: TROLLING SPEED

Below are some of the things which govern the speed at which trolling should be carried out.

Vessel considerations

The type of boat and prevailing wind and sea conditions may limit speed. The motor's fuel consumption, and therefore the fisherman's operating costs, may increase above a certain speed, especially with displacement (non-planing) hulls.

Long skinny boats are faster...

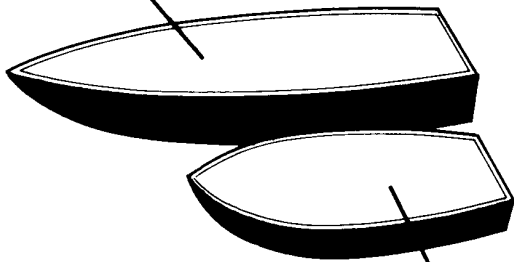

...than short wide ones

Type of bait or lure

Many natural baits do not tow well at high speeds, and in general should not be trolled faster than 5 knots. Many artificial lures can be trolled much faster than this, although some will skip across the water surface unless they are weighted.

Type of line

If a fish strikes a lure towed at high speed, there is a good chance of the lure being torn straight out of its mouth unless you are using reels fitted with a good drag or brake system. If using fixed lines, keep your speed below 6 knots.

Trolling too fast with fixed lines...



...will tear hook from fishes mouth

HULL TYPE LIMITS SPEED

Displacement hull is slower...

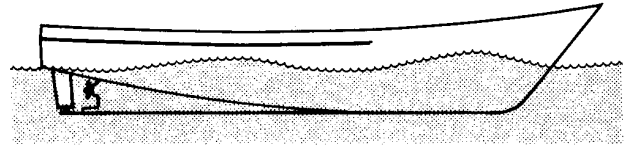

...once it reaches a certain speed, increasing engine power gives extra fuel consumption but not extra speed

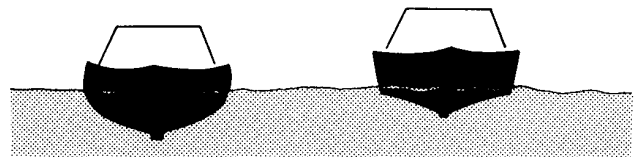

Displacement hull

Planing hull

Planing hull is fast...



...but does not carry much load

BAITS AND LURES

Many baits can't be trolled fast...

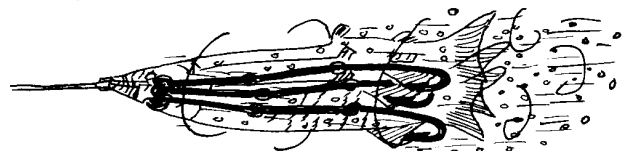

...but some lures are made for high speed

TYPE OF LINE

Trolling too fast with fixed lines...



...will tear hook from fishes mouth

Fish preference

If trolling on tuna schools or otherwise for oceanic species, reasonably high speeds (6 -12 knots) usually get a better biting response among the fish. When trolling across open ocean areas, a high speed also enables the fisherman to cover more ground, and therefore increases the chances of his lure passing among scattered groups of fish. However, lower speeds (under 5 knots) are preferable when trolling in the lagoon and on the reef edge. Many fish species found in these environments tend to be territorial in their habits, and will not chase a fast-moving lure too far from their home ground. Others are simply not fast enough to catch high-speed lures.

TYPE OF FISH



Some fish cannot catch lures trolled at high speed

The human factor

A final and perhaps the most important factor affecting the fisherman's choice and presentation of fishing gear cannot be accounted for. It is the fisherman's own personal preference, based on the way he likes to do things. Some people like fast cars or fancy clothes, while others prefer old bangers or scruffy T-shirts. Likewise, many fishermen choose their boats, gear and fishing style for reasons that may not have very much to do with fishing.

THE HUMAN FACTOR

When choosing fishing boats or gear...

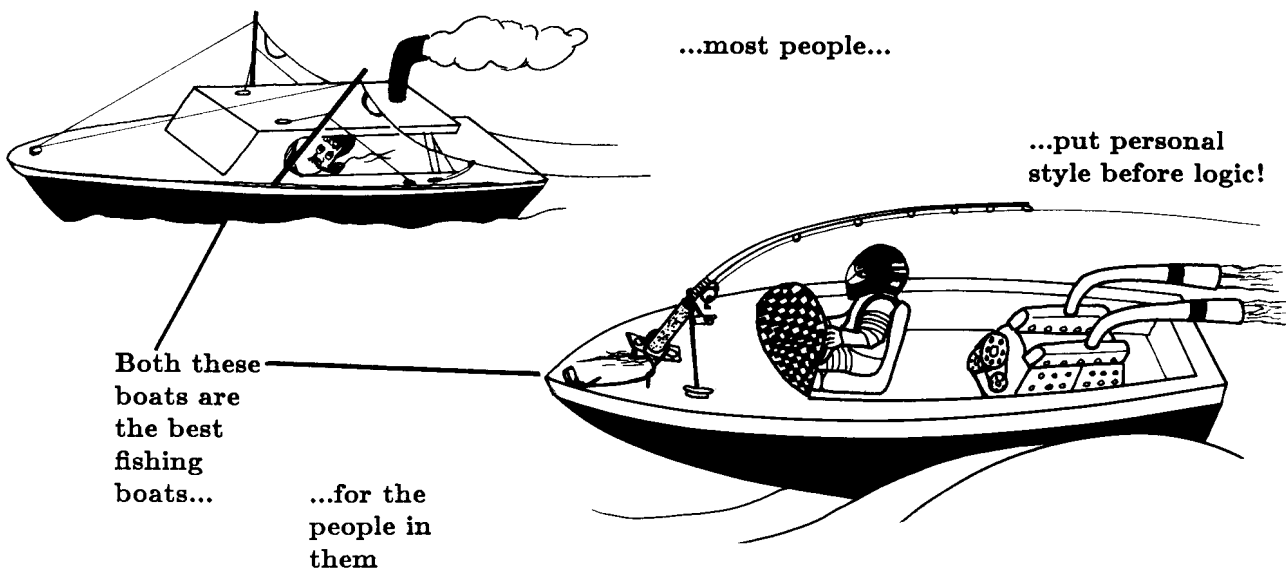



Location: Vanualele, Fiji

Photo: G. L. Preston

Swinging aboard a small skipjack



Location : Koro, Fiji

Photo : G. L. Preston

Gaffing aboard a medium-sized yellowfin

CHAPTER 6

FISHING ACTION

- A. BEFORE SETTING OFF -*Checking the boat -Onboard supplies and equipment
-Consumable Supplies -Effective Fishing -Comfort and common sense -Avoiding accidents ~
Breakdowns -Ready the deck equipment*
- B. WORKING THE LINES -*Deployment -Paying out the line -Gear damage -Fouling*
- C. THE STRIKE -*Spotting strikes -Circling -Drawing in the other lines*
- D. HANDLING FISH ON A FIXED LINE -*Overhand hauling -Wrapping -Releasing the line Practice*
- E. HANDLING FISH ON HANDREELS -*Attaching the brake -Avoiding injury -Winding in*
- F. BOATING THE FISH -*Fish size -Lifting and netting -Gaffing -Gaff actions -Noosing
-Unhooking*
- G. TAKING CARE OF THE CATCH -*Shading and cooling -Bleeding -Cleaning fish -Icing*

CHAPTER 6: FISHING ACTION

SECTION A: BEFORE SETTING OFF

Preparation is a vital part of the fishing trip which should not be overlooked. It is frustrating, time-wasting and often dangerous (especially when trolling long distances) to head out to sea without ensuring that the boat is in good order, or having forgotten important supplies or equipment.

Checking the Boat

Before setting out, look over the boat to ensure that no damage has occurred while it has been unattended, and that no important deck equipment has been removed. Check that the steering and electrics are operating properly, bail or pump the bilges, and generally ready the boat for use.

Onboard supplies and equipment

The equipment required will vary depending on the type of boat, the intended length of the fishing trip, the type of fishing being carried out, local fishing and geographical conditions, and local marine laws and regulations. In planning the needs of your particular vessel, remember -always prepare for unexpected difficulties. As a commercial operator regularly putting out to sea, the chances are good that one day you will have a breakdown, accident or other unpredictable problem. The consequences in personal suffering or loss of property may be serious unless you are properly prepared.

When loading gear on to the boat, stow it tidily so that important items can be found easily. It is a good idea to make a checklist of all the gear that is normally required, and to get into the habit of using it at the beginning of each trip, to ensure that everything you need is on board.

Depending on your own situation, you may need some or all of the equipment from the following groups.

CONSUMABLE SUPPLIES

Plenty of water

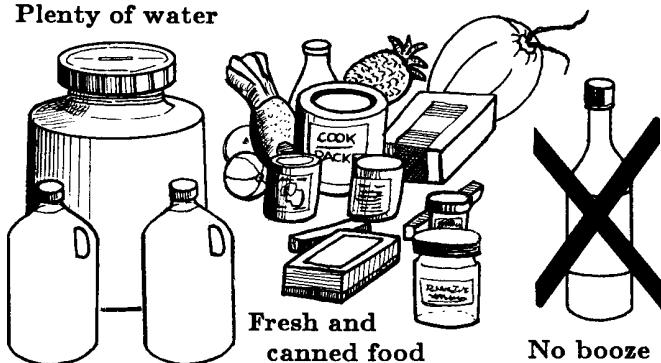

EFFECTIVE FISHING

Lines and lures

Knives and tools



CHECK THE BOAT

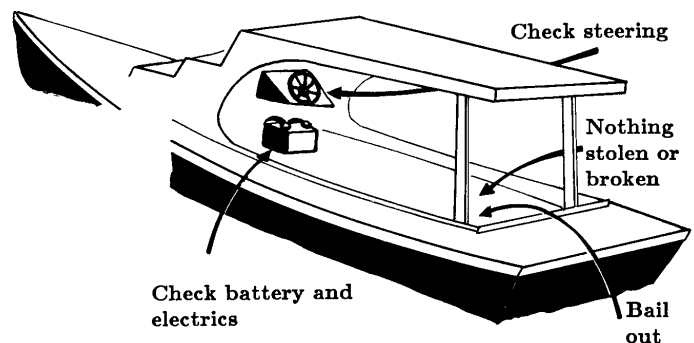

USE A CHECKLIST WHEN LOADING THE BOAT



Consumable Supplies

-Food: fresh and tinned food for the duration of the trip. Try to save tinned food until the end of the trip.

-Drink: take enough for everyone, plus at least two gallons of water extra. Alcoholic drinks are a bad idea on a fishing boat.

-Fuel: for short trips, carry twice as much fuel as you expect to use. For longer trips, take 50 percent extra.

Effective Fishing

-Fishing lines, rigs and lures as required. Try to make up all gear on shore, before setting off.

-Fishing tools: knives, oilstone, pliers, cutter, crimping pliers and sleeves, oil, landing nets or gaffs, shark noose, club. Other items as required. See Section 3A.

-Ice and bait as needed.

-Brush and scaler for cleaning the catch.

Comfort and common sense

-Buckets: take two or more for bailing, cleaning and general use, and for sea anchors or signalling (see Chapter 9).

-Brush and soap for cleaning up slippery decks. - Tarpaulin for sun and rain shelter and emergency use (see Chapter 9).

-Colman lantern, fuel and spare mantles, or torch and spare batteries for night-time lighting and signalling.

-Transistor radio: for weather forecasts.

AVOID ACCIDENTS

Fire extinguisher

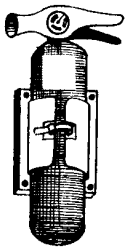

Always use gloves



First aid kit



Life jackets and life buoy



Breakdowns (see Section 9C)

-Engine spares and tools: be ready to fix up minor breakdowns caused by blocked fuel lines, dirty spark plugs, damp electrical wiring, etc. Take spanners, screwdrivers, lubricant, and spare parts as appropriate for your motor.

-Anchor and anchor rope: carry suitable anchor gear to prevent drifting during a breakdown. In deep water use buckets or tarpaulin as a makeshift sea anchor (see Section 9C).

-Diving mask for checking fouled propellor or underwater damage to hull.

-Alternative propulsion. Carry paddles, spare small outboard motor, or sails as appropriate for your boat. A tarpaulin can be rigged as an emergency sail.

Ready the deck equipment

It is a good idea to prepare as much of the deck equipment as possible before leaving sheltered harbour or inshore waters. Rigging and staying of trolling booms, assembly of handreels, attaching mainlines to the booms, laying out of gaffs and other fishing equipment, etc., can all be done at this time.

COMFORT

Brush and soap for decks

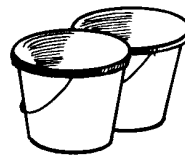

Buckets - cleaning and bailing

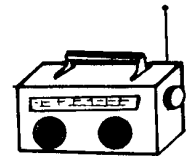

Radio - for weather reports



Lighting - torch and batteries...



...or colman lamp and spare mantles

Avoiding accidents (see Sections 9A and 9B)

-Gloves for handling lines and fish. (see Section 9A).

-First aid kit: should include band-aids and bandages for minor cuts and burns, antiseptic or iodine to prevent infection, aspirin or panadol for pain.

-Lifejackets or life-rings, ideally one per person on board (this is mandatory in some countries). Have one lifejacket or float in easy reach in case someone falls overboard. (See Section 9B).

-Fire extinguisher (mandatory in some countries): very important on wooden or petrol-driven boats. Make sure it is 'B-type', suitable for burning liquids.

BREAKDOWNS



Mask - to check hull and prop

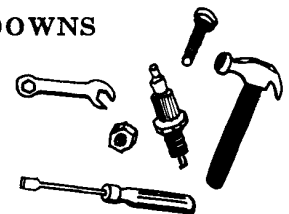

Tools and spares for your engine

Alternative propulsion...



...paddles

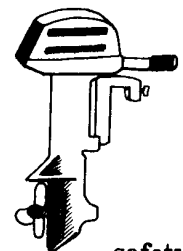

...safety (spare) motor



Tarpaulin for shelter, sail or sea anchor

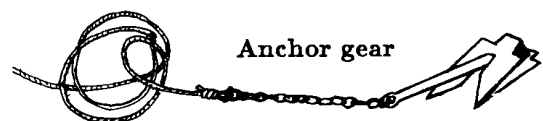

Anchor gear prevents drifting during breakdown

CHAPTER 6: FISHING ACTION

SECTION B: WORKING THE LINES

Once the boat has arrived at the fishing grounds; the lines should be got into the water quickly. Pull them in only when necessary to haul in a fish, or to change or check baits, in order to make the most of the available fishing time.

Deployment

When trolling several lines, those furthest from the boat should be paid out first. In the case of fixed lines, these outer lines should be longer, to enable them to be hauled over the inner ones when being retrieved. If weights or diving boards are being used for deep or sub-surface trolling, the inner lines should be arranged to fish deepest, and the outer ones should be less heavily weighted so as to troll closer to the surface. (This does not apply in the case of handreels, since the lines are not hauled one over the other.)

**When trolling
fixed lines...**

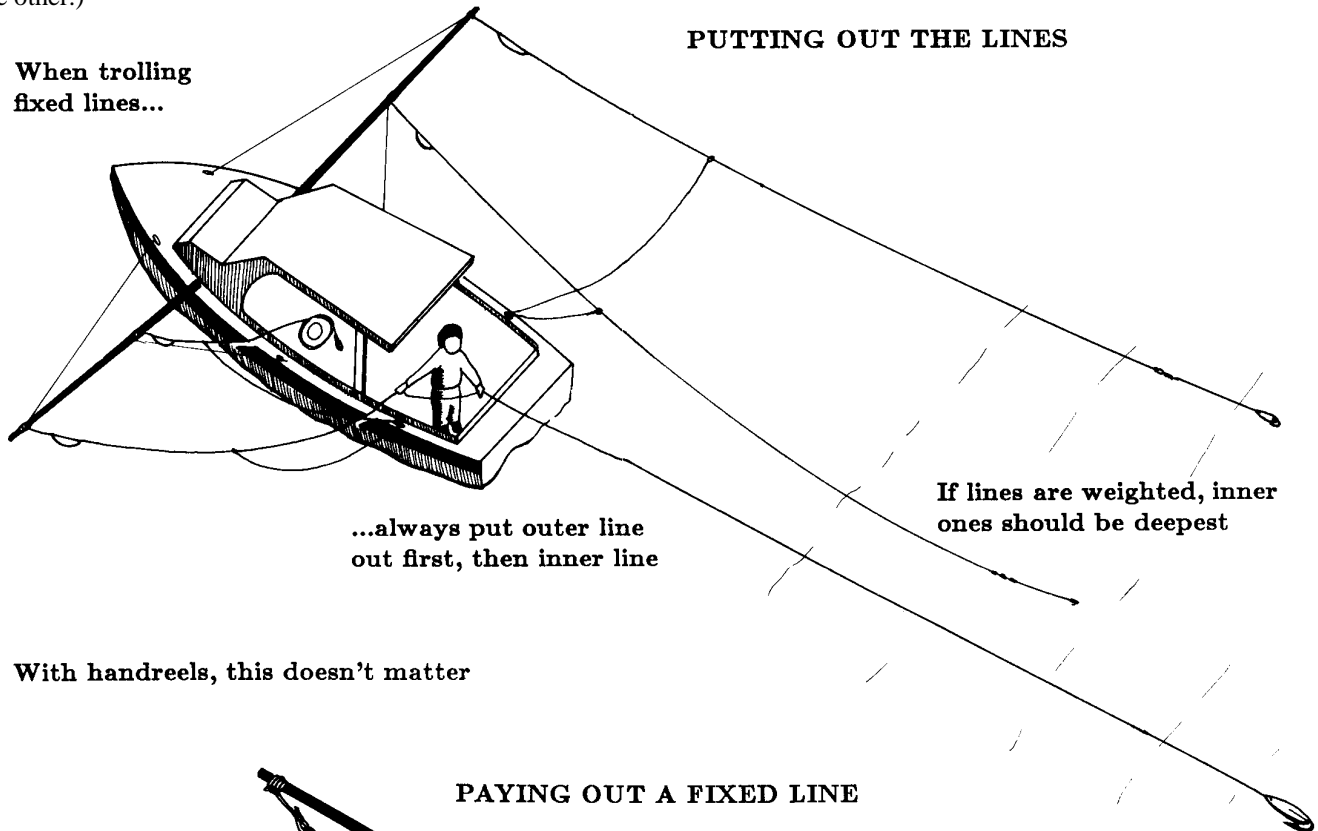

With handreels, this doesn't matter

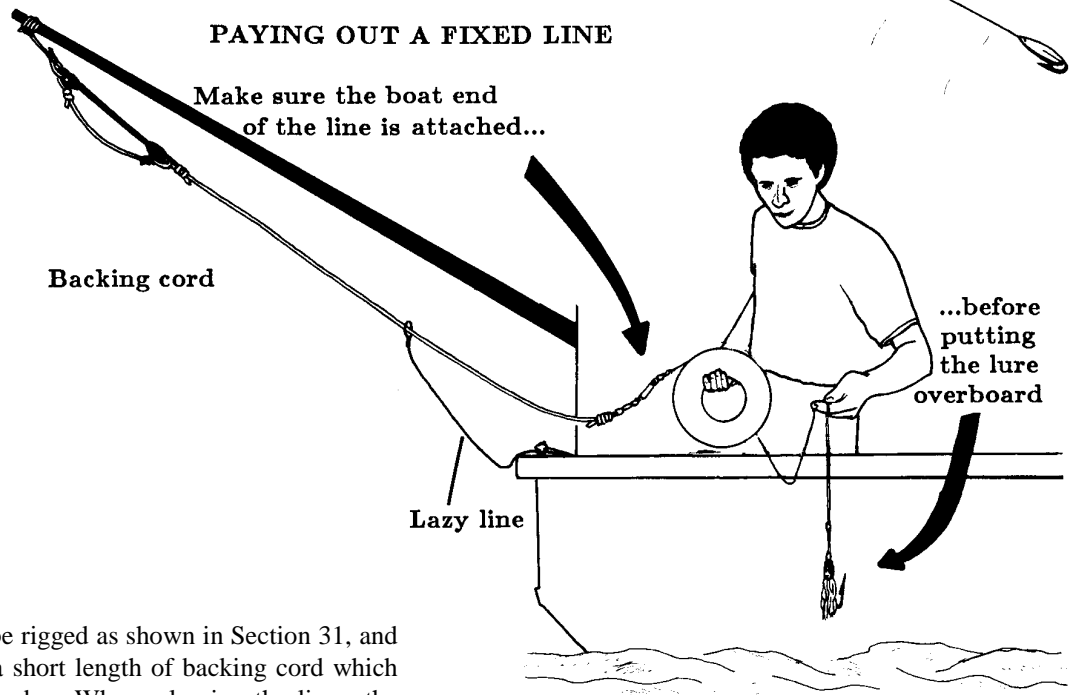

Paying out the line

Fixed lines should be rigged as shown in Section 31, and attached to the boat by a short length of backing cord which incorporates a shock absorber. When releasing the lines, the mainline should be clipped or tied in to the backing before any of the line is released. The bait or lure is then dropped into the water, where its weight will pull first the trace, and then the mainline, overboard.

With handreels, the line should be paid out by slow unwinding from the reel. The reel should not be allowed to spin freely, as this can cause the line to over-run and wrap around the shaft or handle, where it may subsequently be cut, crushed, or overstretched.

When putting a lure in the water, drop or lower it gently over the side of the boat. Do not throw it out, as this may tangle the lure with the line, or tear a natural bait from its hook. Remember to put on the lazy line (see Section 3N) before you start.

PAYING OUT LINE FROM A HAND REEL

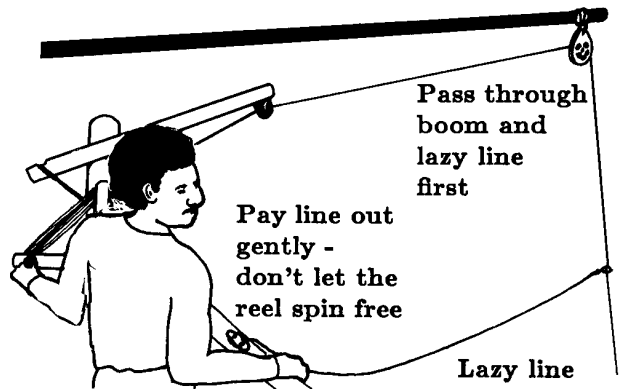

Gear damage

Before the bait or lure goes into the water, check the hooks and trace for any damage which could cause the loss of a fish. In particular make sure that the hooks are sharp and not bent out of shape. Check any knots or sleeves to ensure they are not slipping or coming loose. Look over the trace for wear, rust, fraying, or bad kinks or bends. If you find damage, decide whether you think the gear may break if the next fish is a big one. If you do, or you are in doubt, replace the gear with a new rig, and repair the old one when you get back to shore.

GEAR DAMAGE

Check lines for damage every time you pull them in

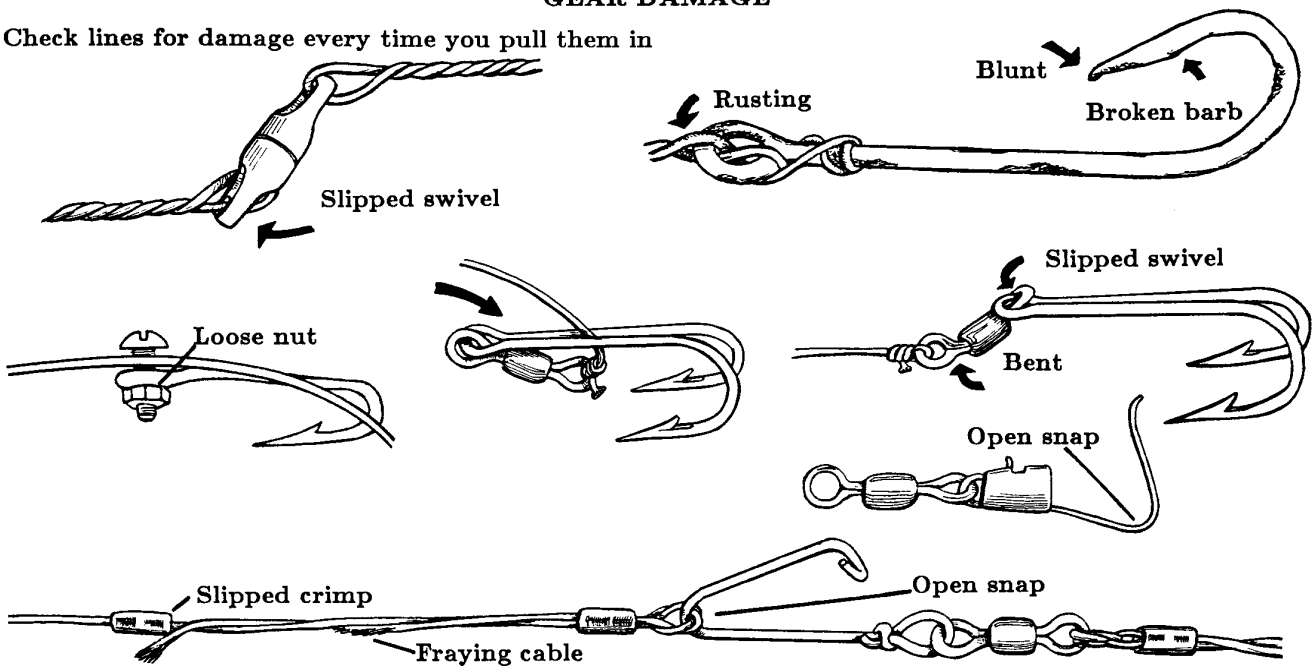

FOULING

Check lures and baits often...



...remove weeds or other rubbish

Fouling

Check lures and baits regularly for fouling, especially if there is a lot of weed or other debris in the water. If the fish are not biting, change lures regularly until you hit on something that works.

The way in which to respond to a strike is discussed in the next section (6C). Techniques for bringing in lines, either with or without fish on them, are discussed in sections 6D and 6E.

CHAPTER 6: FISHING ACTION

SECTION C: THE STRIKE

The strike is the point at which the fish attacks the lure or bait, and, hopefully, becomes hooked.

Spotting strikes

Strikes are not always easy to detect, especially with smaller fish, so the fisherman has to keep a constant eye on his gear. On fixed lines, the rubber shock absorber will stretch, a little or a lot depending on the size of the fish. On a handreel, the rubber brake strap will stretch, and the reel may spin if the fish is a big one. If the lines are trolled from booms, the boom may bend, although if it is properly stayed the bending may not be very great. In some cases, the fish may swim or be pulled to the surface, and may be visible splashing behind the boat.

To help them spot strikes, some fishermen tie a loop knot in the backing cord. A pull on the line makes the knot slip and disappear. This technique is handy when trolling baits. If the knot is gone but no hookup. The bait should be checked straight away as it is probably damaged.

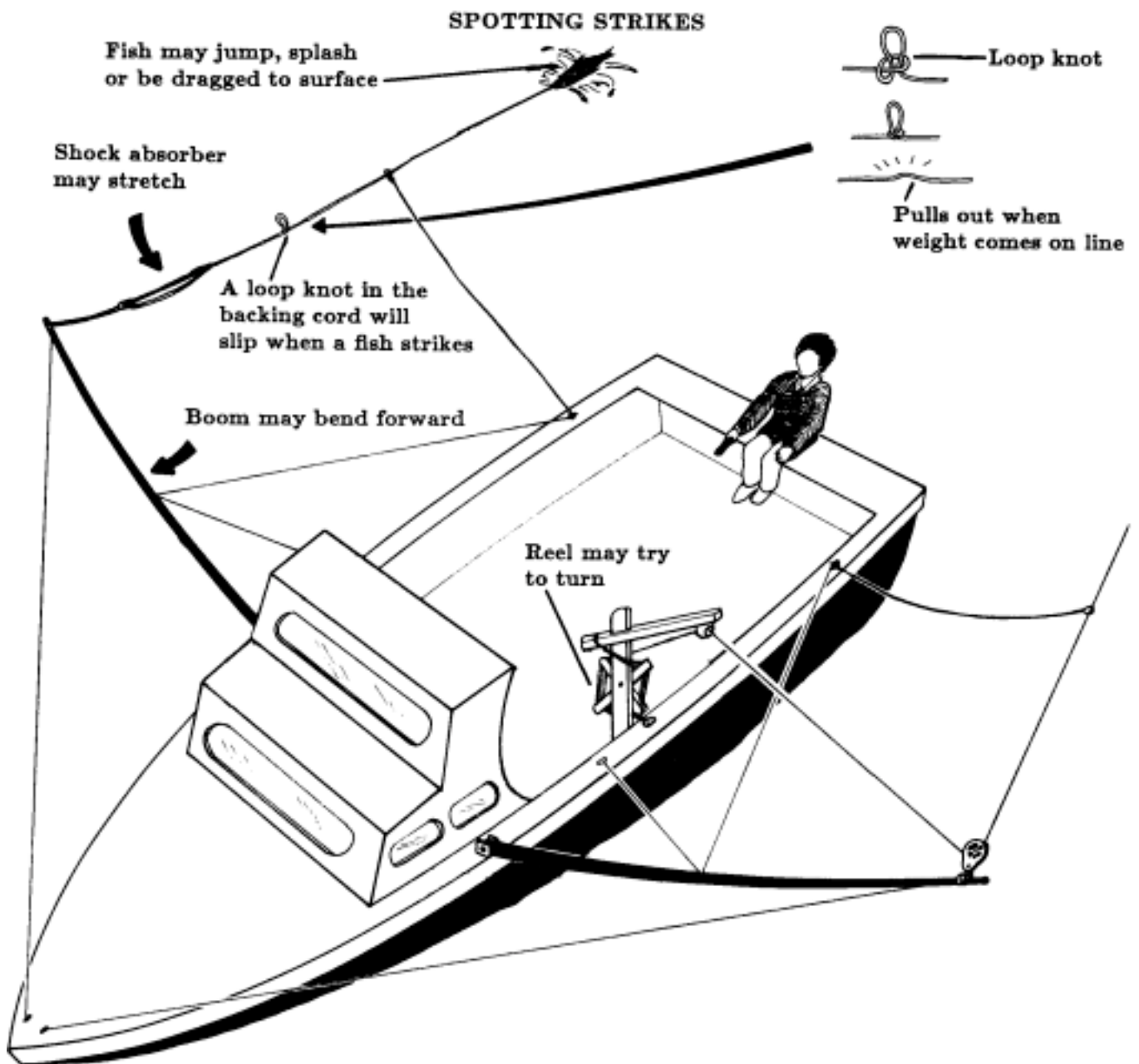

When a strike occurs it may be followed by one or more further strikes. Many fish species are found in groups, so while the first job after spotting a strike is to get the fish into the boat, it is also important to try to encourage more strikes.

Circling

One way in which you can encourage more strikes is to steer the boat into a large-diameter circle. If possible, the hooked fish should be on the inside of the circle, although sea conditions or nearby reefs may not allow this. Circling in this way takes the lures back over the location of the first strike, and, if the fish is on the inside, makes it easier to haul in the line.

CIRCLING

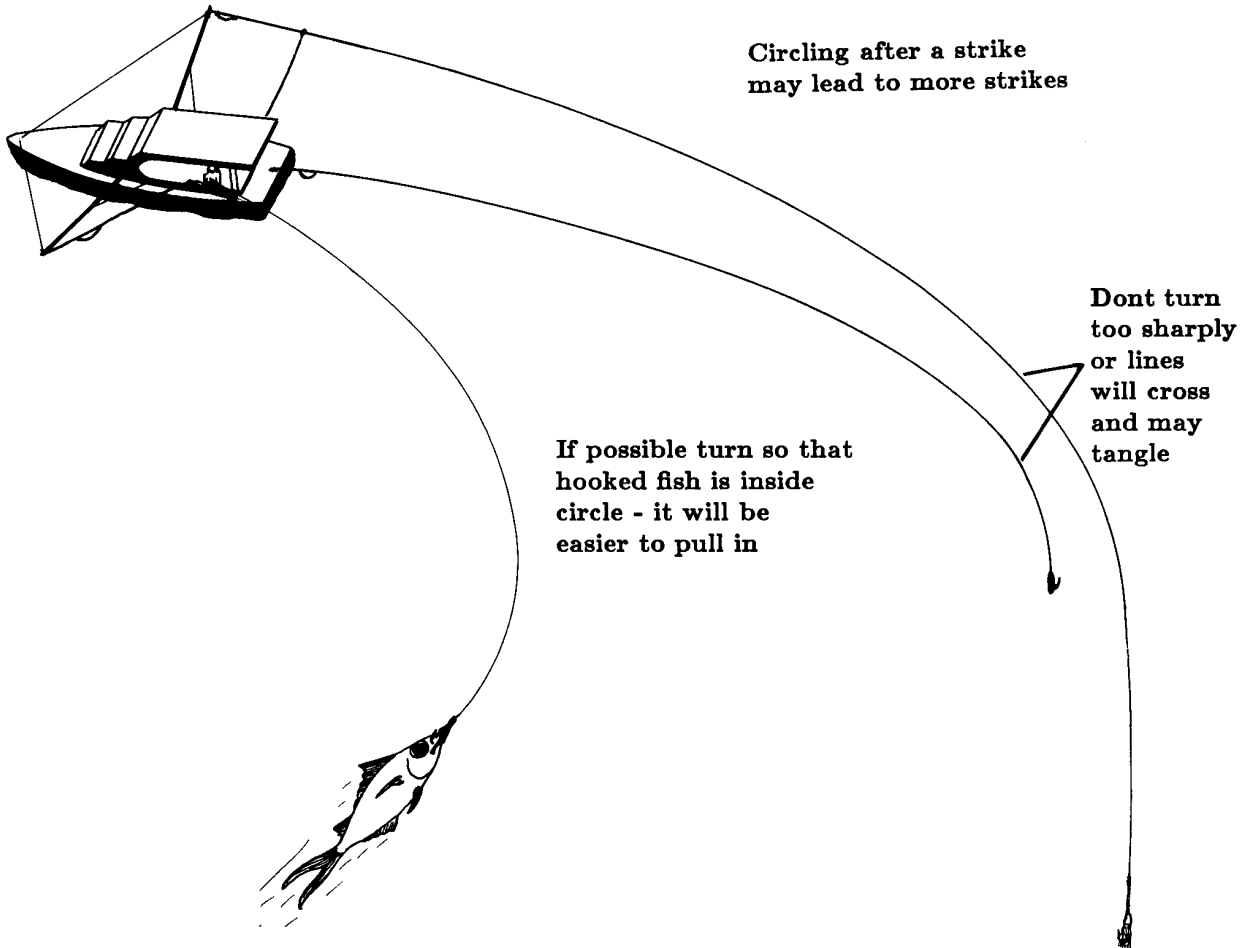

Drawing in the other lines

Another way to encourage additional strikes is to quickly bring in the other trolling lines as soon as the first strike happens. The irregular motion of the lures as they are hauled in seems to excite more fish into attacking them. Pulling in the lines also reduces the chances of tangling if the first fish hooked decides to swim across them. If there are enough crew on board, the other lines can be repeatedly pulled in and let out again to tease other fish into striking.

DRAWING IN THE OTHER LINES

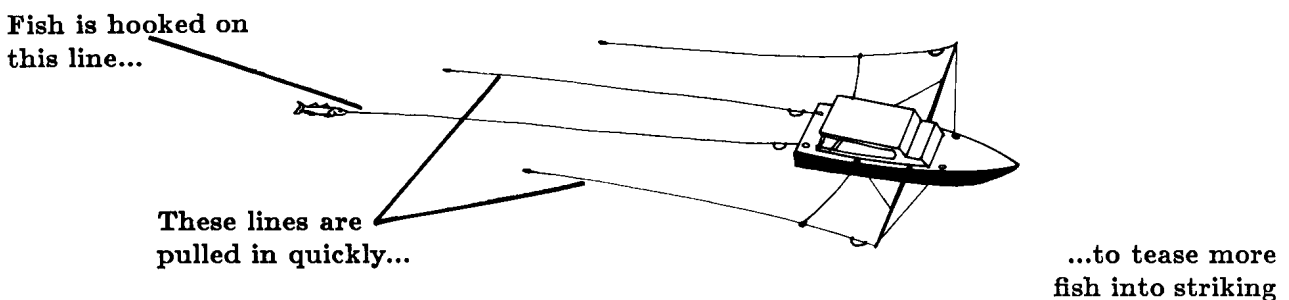

The techniques of handling hooked fish on fixed lines are described in the next section (6D). Handling fish using handreels is discussed in Section 6E.

CHAPTER 6: FISHING ACTION

SECTION D: HANDLING FISH ON FIXED LINES

Fixed lines should be rigged as shown in Section 31, and attached to the boat by a short length of backing cord which incorporates a shock absorber. If the line is fixed onto a trolling boom, then a lazy line should also be attached to the backing cord.

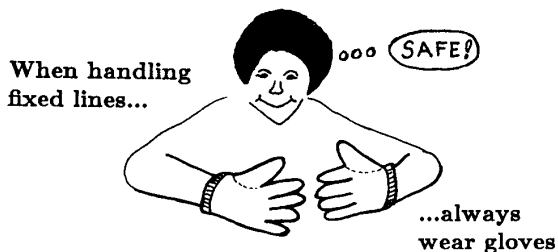

OVERHAND HAULING

Overhand hauling...

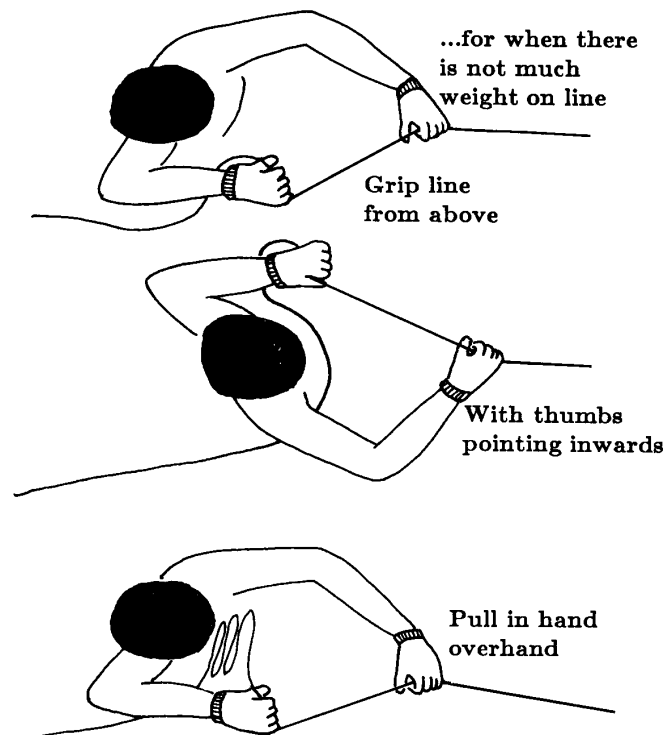

Wrapping

When there is a fish or a very heavy weight on the line, hauling has to be done in a different way. The line is still pulled in overhand, but with one or two wraps being taken around the hand to prevent slipping. The wrap is taken by bringing the palm of the hand up against the line, the thumbs pointing away from the body. The hand is then moved around the line in a circle, with the result that the line takes a complete turn around it. For very heavy fish, it may be necessary to take a second wrap, the same as the first. The result is that the line lies across the palm, with the weight against the heel or back of the hand. The line can then be gripped firmly by closing the fingers around it. By carrying out the procedure with one hand and then the other, hauling proceeds a metre (3 feet) or so at a time.

Overhand hauling

When handling fixed lines, gloves should always be worn, particularly if wire is being used. To bring in a line for checking or changing lures, first grasp the backing cord (by pulling in the lazy line, for those lines attached to a trolling boom). Then pull in the line with a handover-hand action, gripping the line from above with the thumbs pointing inwards toward the body. This action gives a good grip on slippery lines, and, provided that there is not too much weight on the line, allows fast recovery.

WRAPPING

For when there is a heavy weight on line

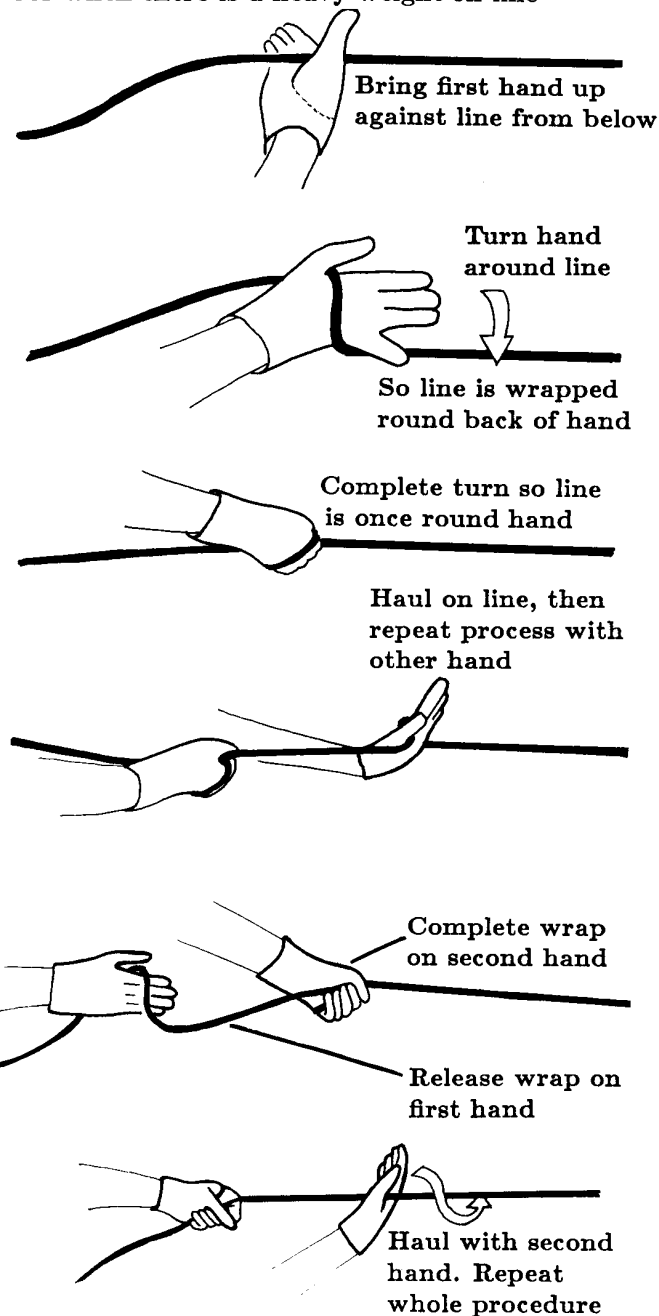

Releasing the line

The wrapping method of hauling is quite unnerving to a novice, especially when using piano or other singlestrand wire. However, the only real danger is that the wire will start to slip and cut through the gloves and into the hands. Slipping will only occur if the weight on the line is very great (more than 100 kgs (220 lbs) or so), or if the fisherman is not gripping the line tightly enough (often due to lack of confidence in the technique). If the line does start to slip, or the weight is too much to handle, the line can be instantly released by opening the hands and shaking off the loops.

PRACTICE

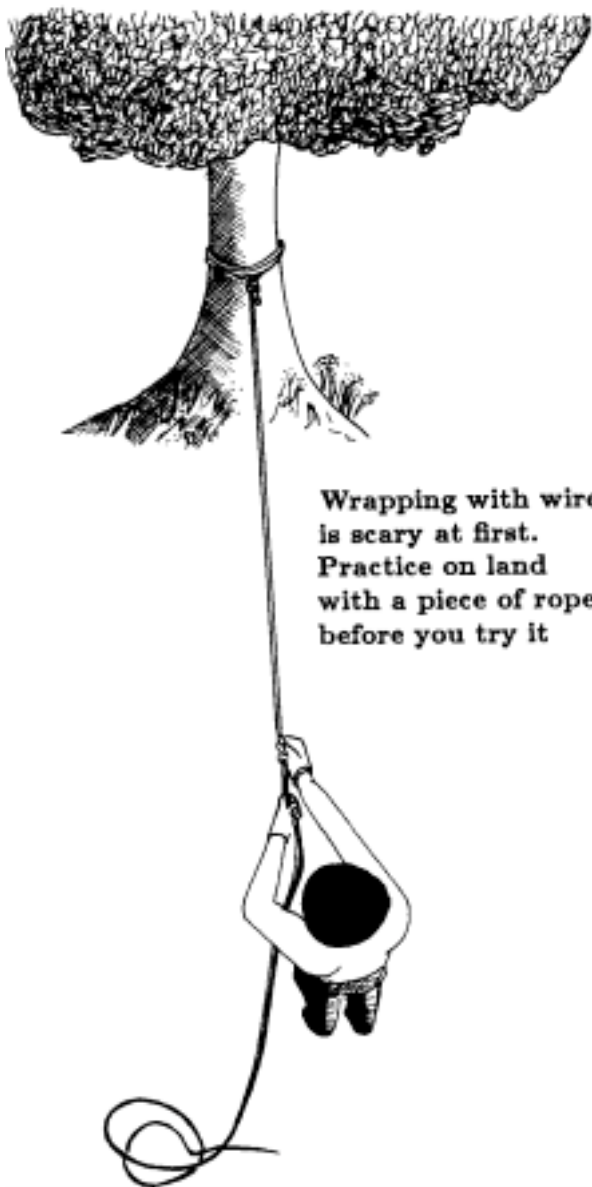

Wrapping with wire is scary at first. Practice on land with a piece of rope before you try it

RELEASING THE LINE

As long as you wear gloves there is no danger to hands when wrapping even when using piano wire...

...unless the line starts to slip. To prevent slipping always grip tightly

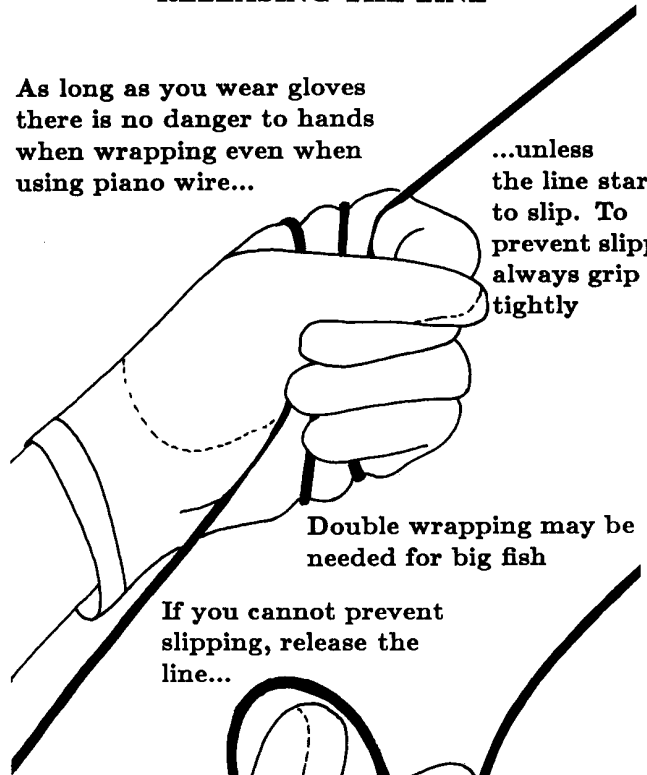

Double wrapping may be needed for big fish

If you cannot prevent slipping, release the line...

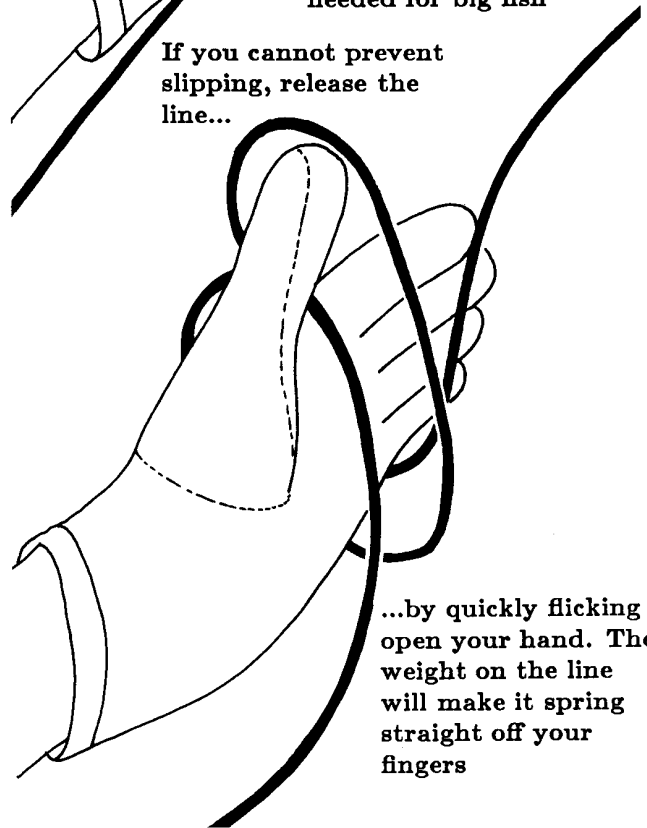

...by quickly flicking open your hand. The weight on the line will make it spring straight off your fingers

Practice

Confidence in the technique is very important when hauling lines by wrapping. Those not familiar with the technique should practice on a rope tied to a tree, or a lightly weighted monofilament line towed behind the boat, before attempting to haul single-strand wire. Once mastered, this is a rapid and efficient way to haul fine or slippery lines, and will not cause kinking or bending in most types of wire.

When the fish is close to the vessel, it should be manoeuvred into a position suitable for boating, as discussed in Section 6F.

CHAPTER 6: FISHING ACTION

SECTION E: HANDLING FISH ON HANDREELS

Handreels should be rigged with a brake loop as shown in Section 3N. The mainline should be put through the insulator on the reel arm (and also through the boom eye and lazy line loop, when a trolling boom is being used), before attaching the trace, as the lure or bait is normally too large to pass through these holes.

When paying out the line, line length can be estimated by counting the number of turns if the reel. On most 'standard' wooden handreels, one turn is about one metre (3 feet 4 inches).

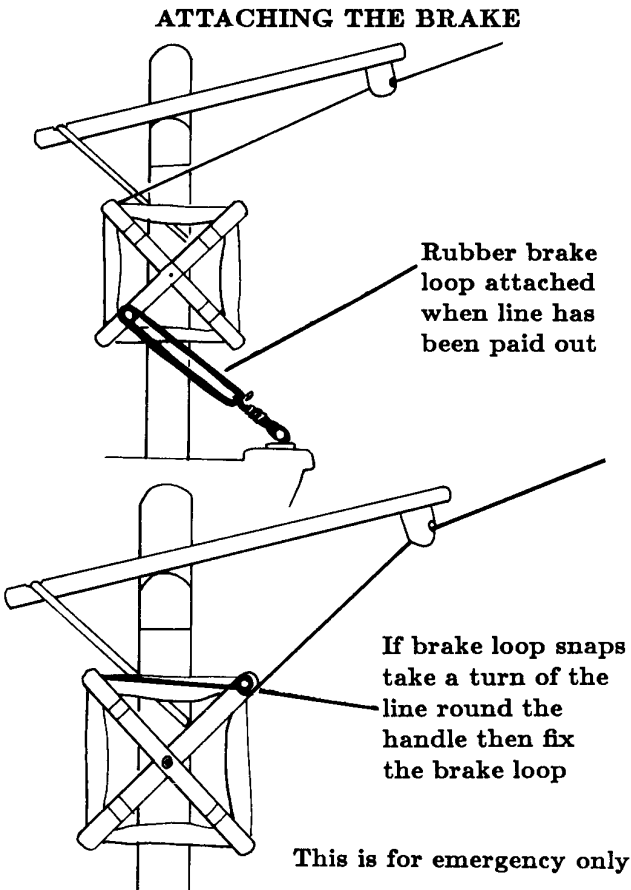

A voiding injury

During fishing, the fisherman should not rest with his hands on the reel, or stand too close to it. When a large fish strikes, the reel is likely to spin rapidly, and can cause a severe injury to any part of the body in its way. Provided that the brake strap is on the reel, the line will not over-run and the fish will tire itself making its initial fight against the resistance of the rubber, rather than the fisherman. Once the reel has stopped spinning, the load can be taken by the fisherman, the brake loop lifted off, and the fish reeled in.

If the fish pulls too hard for the fisherman to control, he should replace the brake loop and stand back for a minute or two while the fish fights the rubber. There is no point in exhausting yourself fighting a fish, and there is always the danger that you will resist him too strongly and break him off.

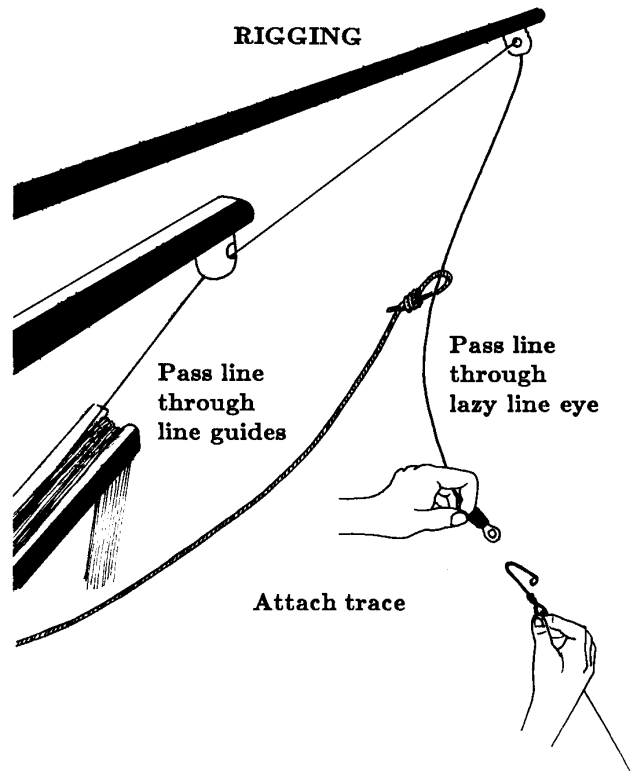

Attaching the brake

When the line has been paid out to the desired length, the rubber brake strap should be looped over the reel handle. This will prevent any more line paying out, and act as a shock absorber in the event of a strike.

If the brake loop snaps or gets broken, the line can be looped behind the reel handle to prevent the line running out. This system eliminates all the advantages of a handreel since it does not provide any 'give' when a fish strikes. It should therefore only be used as an emergency measure.

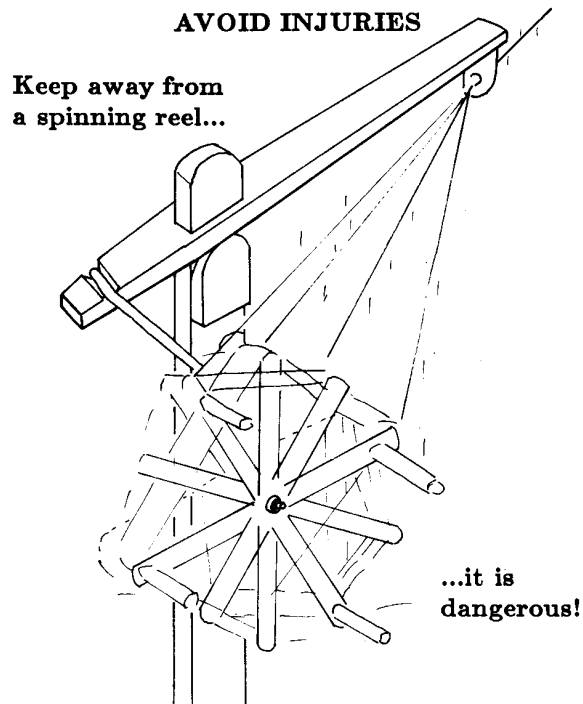

Winding in

Bringing in the line is simple and quick with a handreel. The mainline is normally wound onto the reel, until the attachment point to the trace is about level with the stern of the boat. Wire traces should not be wound in further than this, as they will kink or curl when pulled through a boom eye or insulator.

WINDING IN

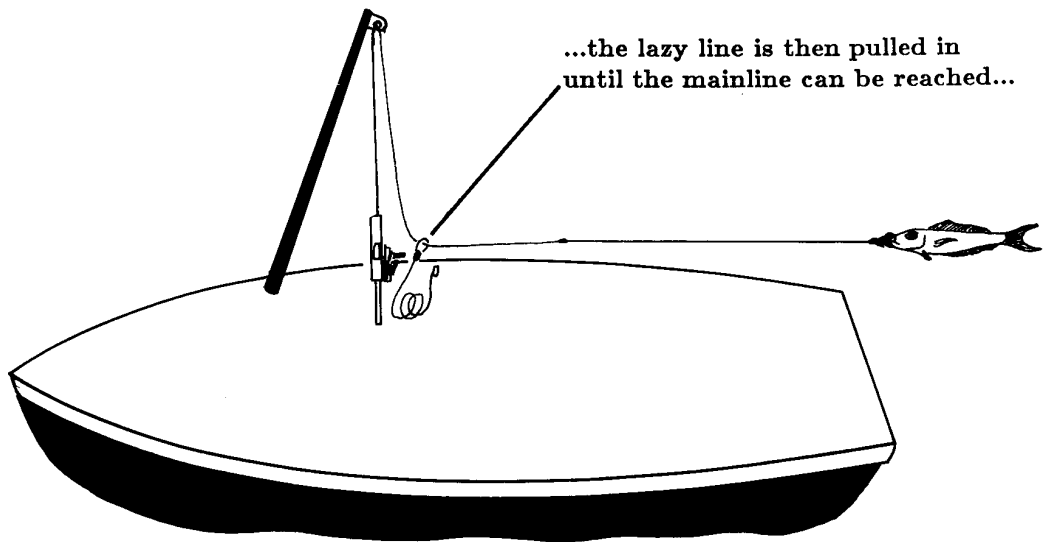
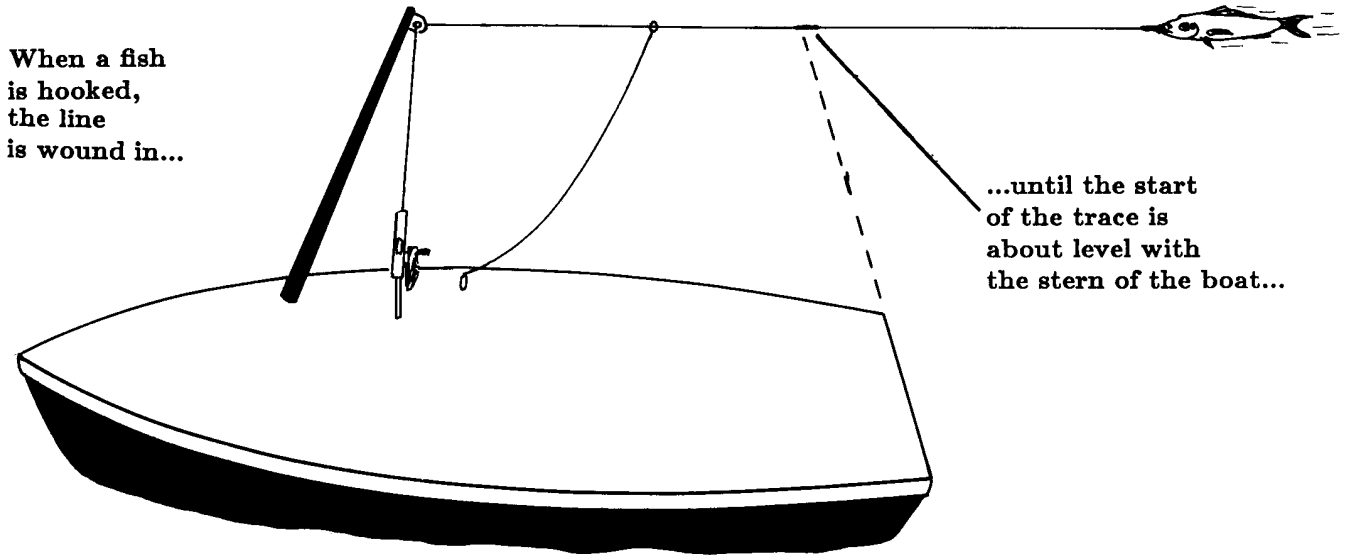

...and the rest is hauled in hand-over-hand

The line is then retrieved (by pulling in the lazy line, when rigged through a trolling boom) and the trace hauled in hand-over-hand, as described in Section 6D. Note that the procedure is different from that with fixed line: with a handreel, the fish is brought close to the boat before pulling in the lazy line; with a fixed line, the lazy line has to be pulled in first, before hauling can begin.

When the fish is close to the vessel, it should be manoeuvred into a position suitable for boating, as discussed in Section 6F.

CHAPTER 6: FISHING ACTION

SECTION F: BOATING THE FISH

The time when a fish is being lifted from the water into the boat is the time when it is most likely to be lost. Extra weight may come on to the hooks, and tear them from the fish's mouth, or the fish may unhook itself as it thrashes in panic. It is therefore important to boat the fish in a smooth, efficient manner, using a net, gaff or other landing tool (see Section 2H).

Fish size

The size of the fish can usually be estimated while it is being hauled in. When it first comes into view as it is brought towards the boat, the size can be confirmed and a decision made as to whether a net or gaff will be needed. As a general rule, fish under about 2 kg (5 lbs) can be lifted straight into the boat, fish between 2 kg and 5 kg (5 and 12 lbs) should be landed using a net or small gaff, and those over 5 kg (12 lbs) should be gaffed. Very large fish or sharks may need two or more of the crew, with a gaff each, to boat them.

NETTING

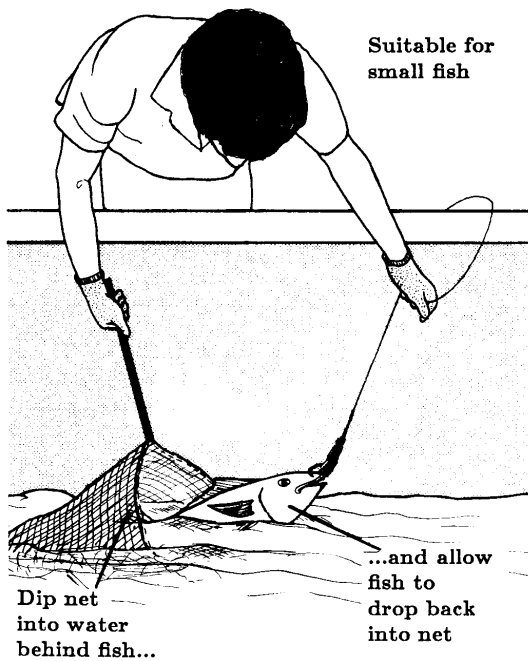

Gaffing

Gaffing is by far the most popular method of boating fish. Some different types of gaff are described in Section 2H. Whenever possible, the fish should be gaffed in the head. This avoids damage to the flesh, and may help stun or kill the fish. A fish gaffed through the body has more leverage to use when thrashing about, and may succeed in leaping off the gaff and back into the water.

FISH SIZE

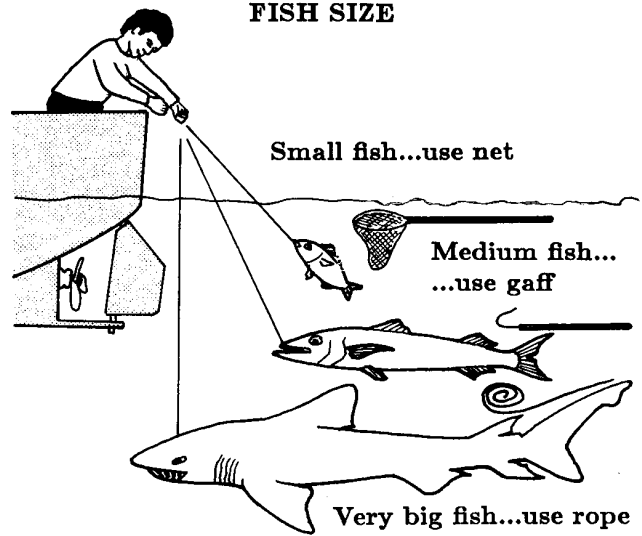

Lifting and netting

Lifting fish aboard is a simple operation. The trace should be grasped a foot or two in front of the hook and the fish lifted smoothly out of the water and into the killing box or other receptacle.

When netting, the trace is grasped in the same place, and the net brought up over the tail and body of the fish from behind. Nets have a lot of drag when dipped into the water from a moving boat, so the netting action needs to be smooth and strong.

GAFFING

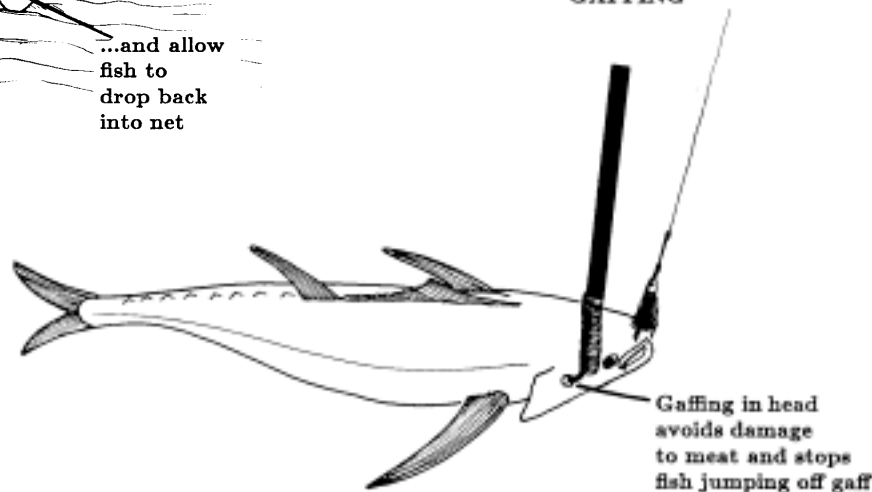

Gaff actions

The actions of the two main types of gaff, the 'L'-gaff and the 'J'-gaff, are shown below. The L-gaff is used mainly on smaller-sized fish, and the action is to strike down on the fish from above. The J-gaff is more common and is better for larger, heavy fish. The action is to reach over and beyond the fish with the gaff, and then jerk back towards the boat, sinking the gaff home. The fish can then be hauled aboard with both hands holding the gaff handle.

'J'-GAFF ACTION

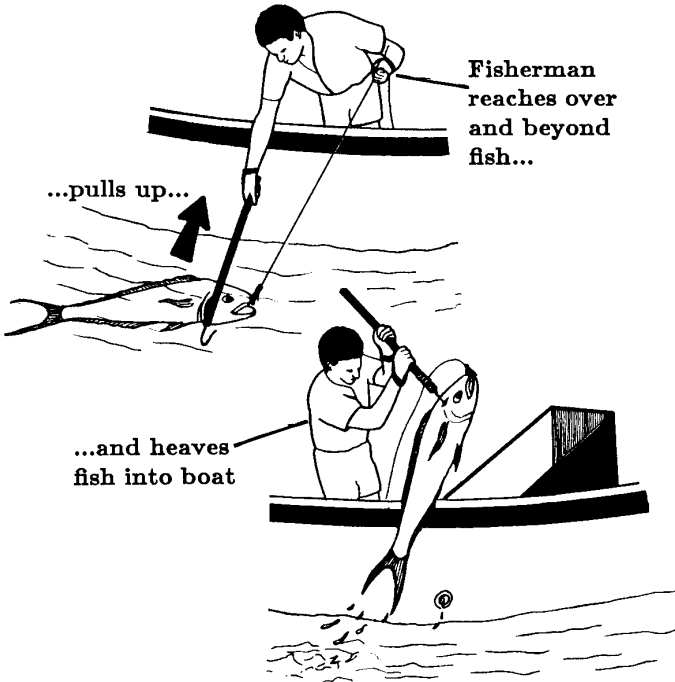

'L'-GAFF ACTION

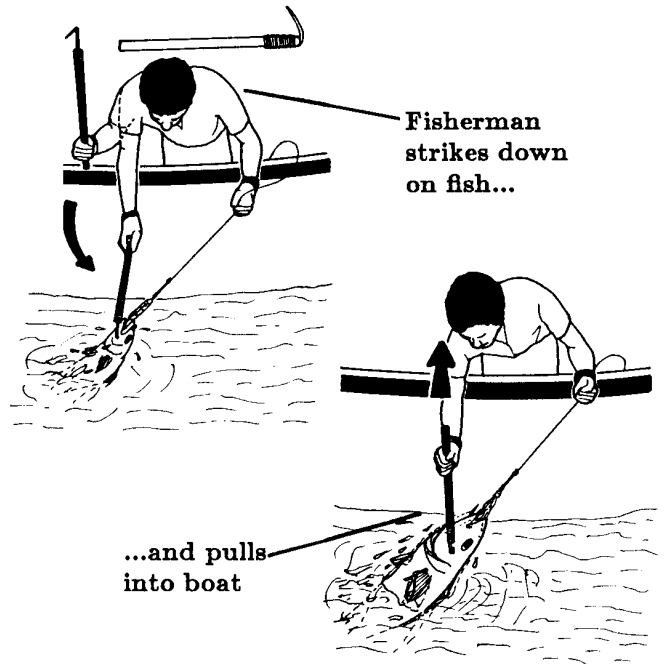

Noosing

Noosing is mainly used as a way of manhandling sharks or other fish which are too large to be brought aboard by one or two men using gaffs. A length of stiff sinking rope should be used -longline cord is ideal. The rope is passed around the line on which the shark is hooked, and the end is then tied in a bowline knot around the standing part of the rope. This forms a noose which is then opened up wide and allowed to slide down the line and into the water. The shark is held close to the water surface using the fishing line, and the noose is manoeuvred over the its head, with the help of gaffs if necessary, until it is around the gill area. It is not necessary to get the rope back over the sharks fins -this is just about impossible with some long-finned types. Once the noose is around the gill area, it is pulled tight, and the shark can then be hauled aboard, or just tied off until it dies.

NOOSING

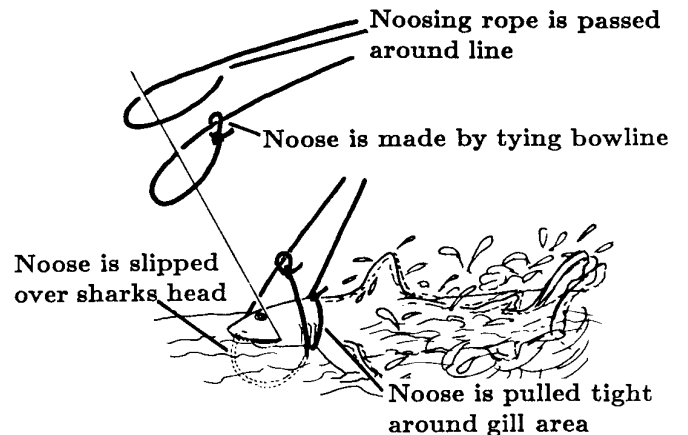

Unhooking

Once the fish is on board, it should be lifted straight into the killing box or a part of the boat where it can be controlled for unhooking. The fish should be held and controlled with the gaff to make unhooking easier. The hooks can be removed by hand, or with the aid of pliers and a knife, depending on the type of fish and the way it is hooked. Once hooks are removed, the fish can be dropped off the gaff into the killing box.

UNHOOKING

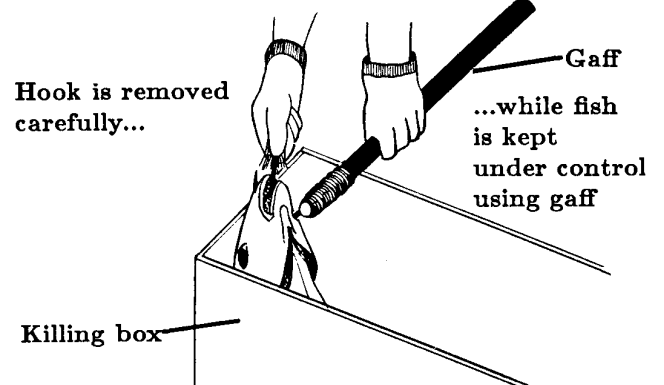

CHAPTER 6: FISHING ACTION

SECTION G: TAKING CARE OF THE CATCH

Commercial fishermen can usually expect to get more money for their fish if it looks well handled and presented. Taking care of the catch starts from the minute the fish is boated, and may involve only a little effort on the fisherman's part.

Shading and cooling

Fish should always be protected from the sun, which makes them decay much faster and dries out the surface, resulting in a poor appearance. If possible, put a board or cover over the killing box to shade the fish. Alternatively, cover them with sacking or some similar material. Throw a bucket of seawater over them from time to time to prevent drying, wash off blood and slime, and keep the fish cool.

SHADING AND COOLING

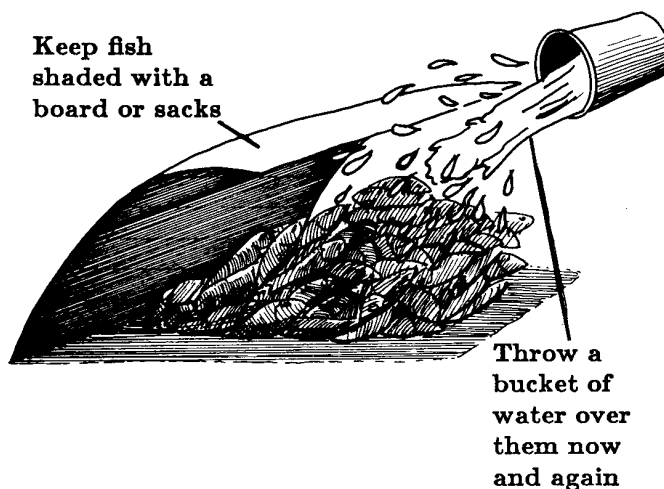

BLEEDING

A quick and clean way to bleed fish...

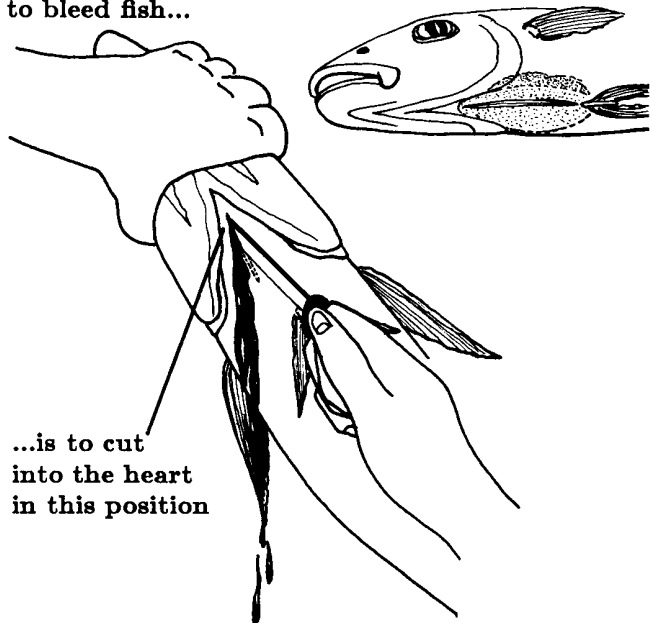

Bleeding

If the fish will ultimately be sold as fillets, it is usually worth bleeding them while still alive. This ensures that the flesh of white fish will be truly white -not pink or grey -when filleted. Bleeding also helps remove the lactic acid which builds up in the fish's body when it is struggling on the line. This can cause the flesh to become soft and jelly-like, especially in fatty fish like tunas.

Easier but less tidy...

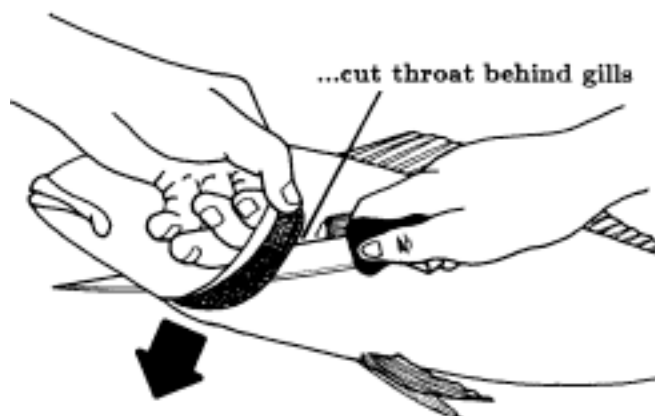

Bleeding is done by slitting the 'throat' of the fish while it is still on the hook or gaff. The most inconspicuous way is to make the incision into the heart region of the fish, between the ventral fins. When the appearance of the whole fish is less important, a knife can simply be pushed behind the gills, cutting through the throat from the inside.

Cleaning fish

In some locations, the market requires fish to be landed whole, in others consumers prefer their fish to be cleaned -that is either gutted, gilled, scaled, or some combination of these. If the fish do have to be cleaned, this should be done reasonably soon after the fish has died in the killing box, perhaps during a lull in the fishing. If time does not permit this, the fish can be iced down whole and cleaned later, after the fishing is finished.

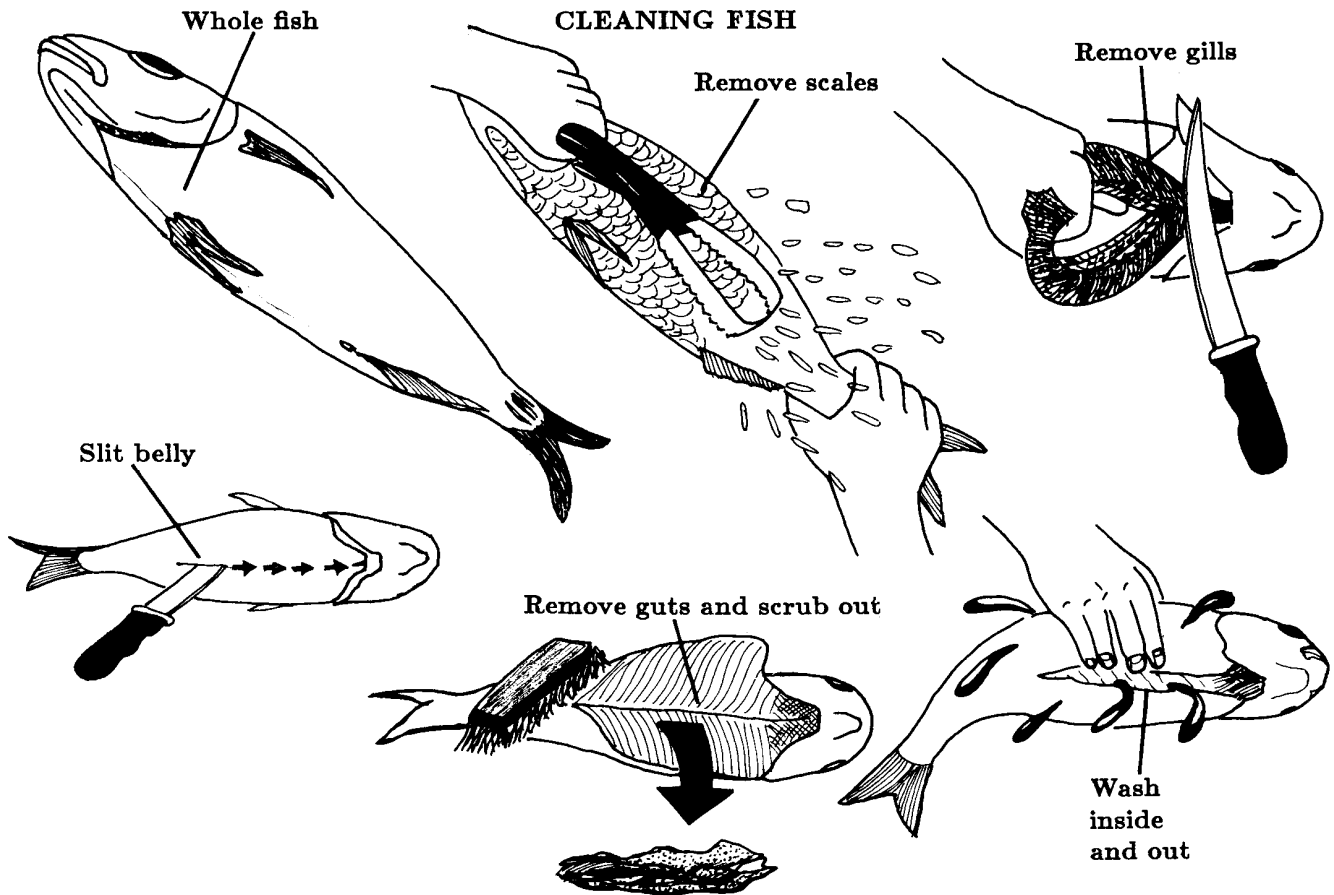

PROPER ICING

Icing

If the fishing trip is longer than a few hours, then ice should be carried and the fish iced down as soon as possible after capture. The best way is to allow fish to accumulate in the killing box for an hour or two, or until a reasonable quantity has been caught, and then transfer them to the ice box. Working to this type of pattern avoids too much interruption to the fishing, and unnecessary opening of the ice box. When put into the ice box, the fish should be properly layered or mixed with the ice to ensure rapid and complete cooling.

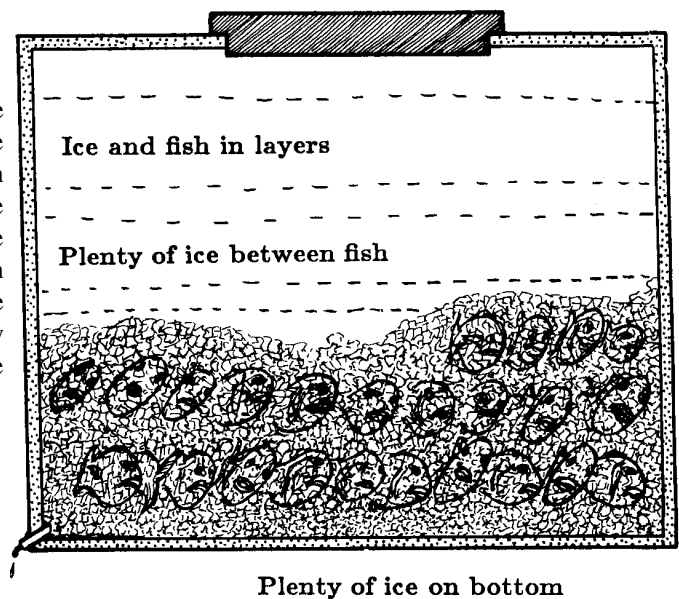



Location: Nukulaelae, Tuvalu

Photo: L.B. Chapman

Wahoo trolled between atolls in the central Pacific



Location: Niue Island

Photo : P. D. Mead

The catch from a short trolling trip by a dinghy fisherman

CHAPTER 7

COMMONLY CAUGHT FISH

- A. FISH HABITATS
- B. SURFACE SCHOOLING TUNAS
- C. LARGER TUNAS BIG EYE AND YELLOWFIN
- D. DOGTOOTH TUNA
- E. DOLPHIN FISH
- F. WAHOO
- G. SPANISH MACKEREL
- H. BARRACUDA
- I. TREV ALLIES
- J. DOUBLE-LINED MACKEREL
- K. CORAL TROUTS AND GROUPERS
- L. SHARKS
- M. OTHERS

CHAPTER 7: COMMONLY CAUGHT FISH

SECTION A: FISH HABITATS







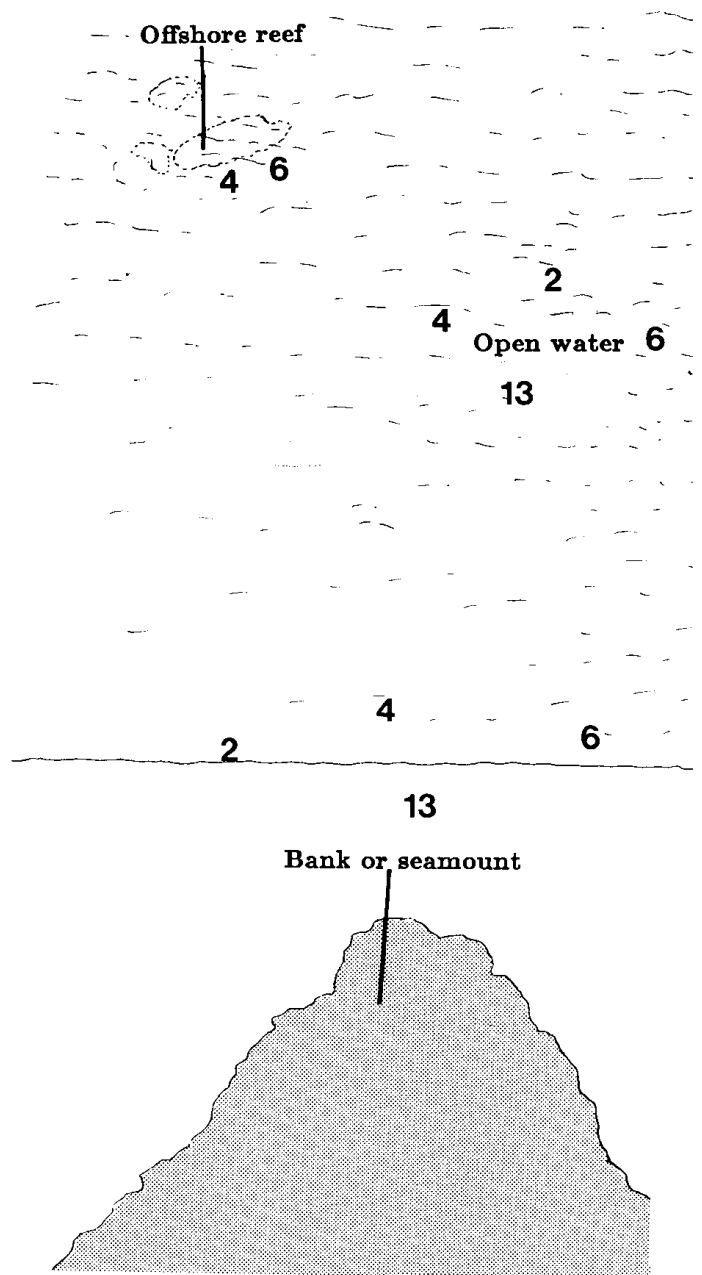





The types of fish caught during any trolling trip will be determined by a number of factors, the most important of which is the trolling area as discussed in Chapter 5. Different fish species typically occupy particular habitats, or types of area. For instance, skipjack tuna can generally be said to live in the surface waters of the open ocean, while coral trouts are normally found living in close association with the reef. Where habitats overlap -in this case, where relatively open ocean waters are interrupted by coral reefs -both types of fish may sometimes be encountered in the same area.

The diagram opposite shows the type of habitat usually occupied by the more important species of fish caught by trolling. The drawing is only a generalisation, however, as it very frequently happens that a given type of fish is caught far away from where it would normally be expected. Therefore, a fisherman trolling along the outer barrier reef will catch mainly reef-associated species, but can also expect a number of fish from a more oceanic environment, which happened to be close to the reef at the time. Conversely, surface trolling in open water should produce principally surface-living oceanic types, but it is likely that some 'stray' deeper-living fish, which have come closer to the surface, will also be taken.

Many other factors will also play their parts in determining the species composition, and for that matter the quantity, of the fish caught. These include season, tide, time of day, trolling speed, gear presentation, and the many other variables discussed in Chapter 5. Since some species are more valuable or acceptable than others, most fishermen wish to selectively catch one or several particular types of fish. The rest of this chapter deals with the characteristics of the species most commonly caught by trolling, and suggests some ways in which fishermen can modify their techniques in order to improve catches of these types.



FISH SPECIES

- 1) Skipjack 
- 2) Dolphin fish 
- 3) Juvenile yellowfin and bigeye 
- 4) Adult yellowfin and bigeye 
- 5) Dogtooth tuna 
- 6) Wahoo 
- 7) Spanish mackerel 
- 8) Barracuda 
- 9) Trevally 
- 10) Coral trout 
- 11) Double lined mackerel 
- 12) Shark 
- 13) Billfish 

FISH HABITATS

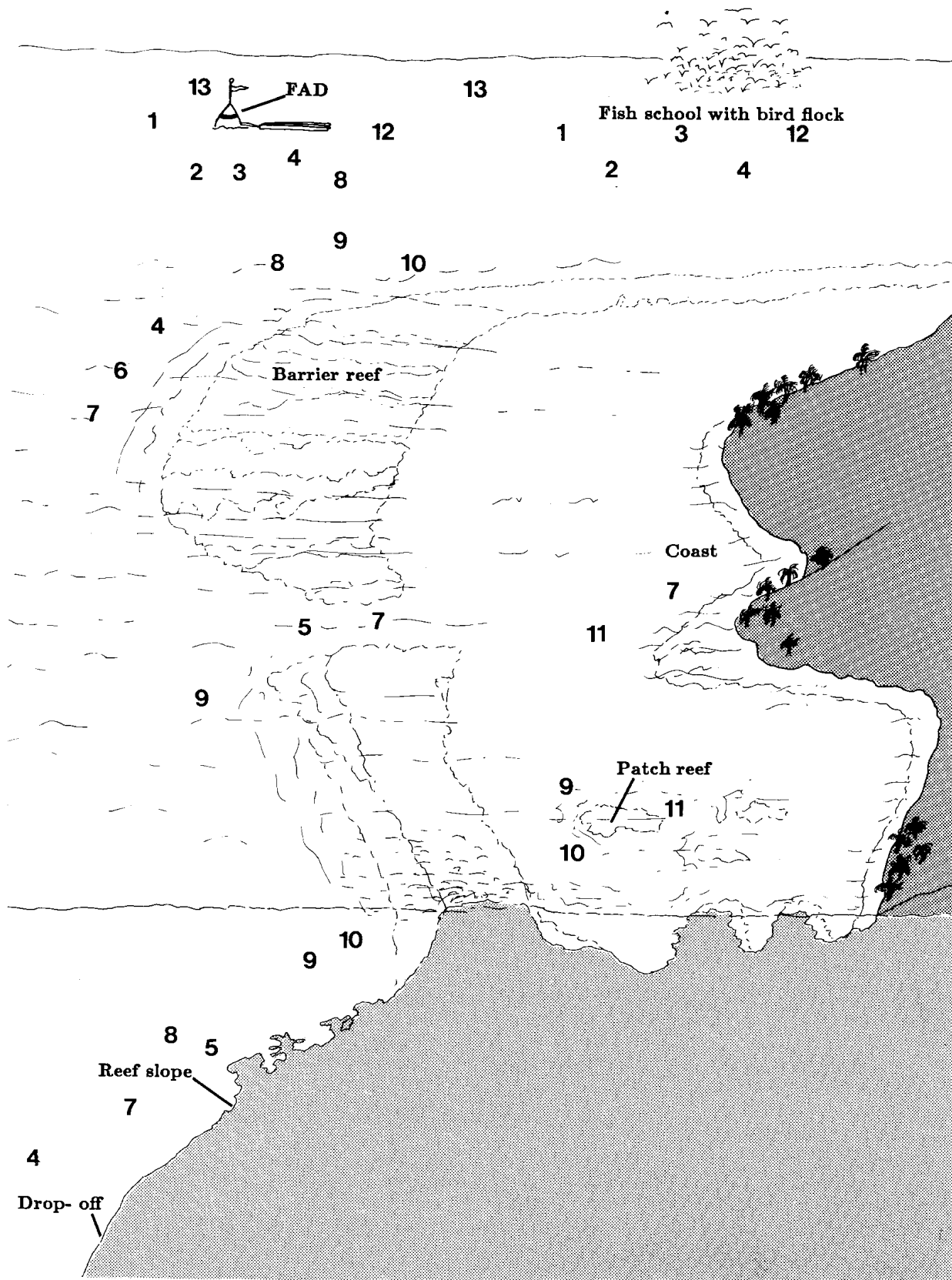

CHAPTER 7 : COMMONLY CAUGHT FISH

SECTION B: SURFACE SCHOOLING TUNAS

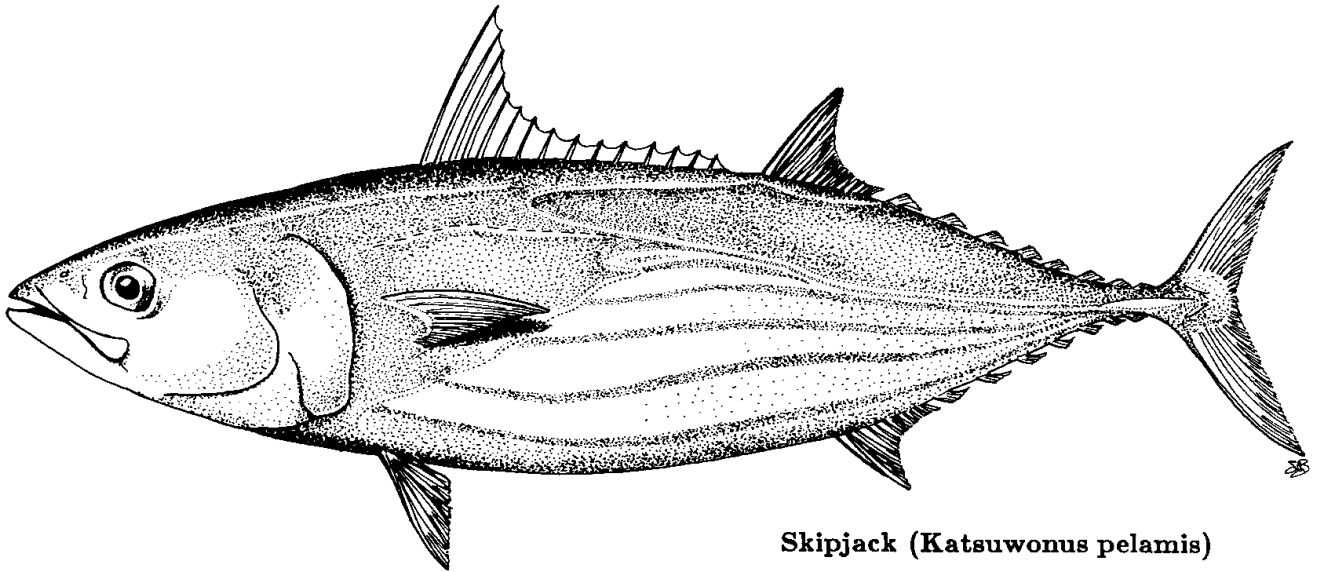

Skipjack (*Katsuwonus pelamis*)

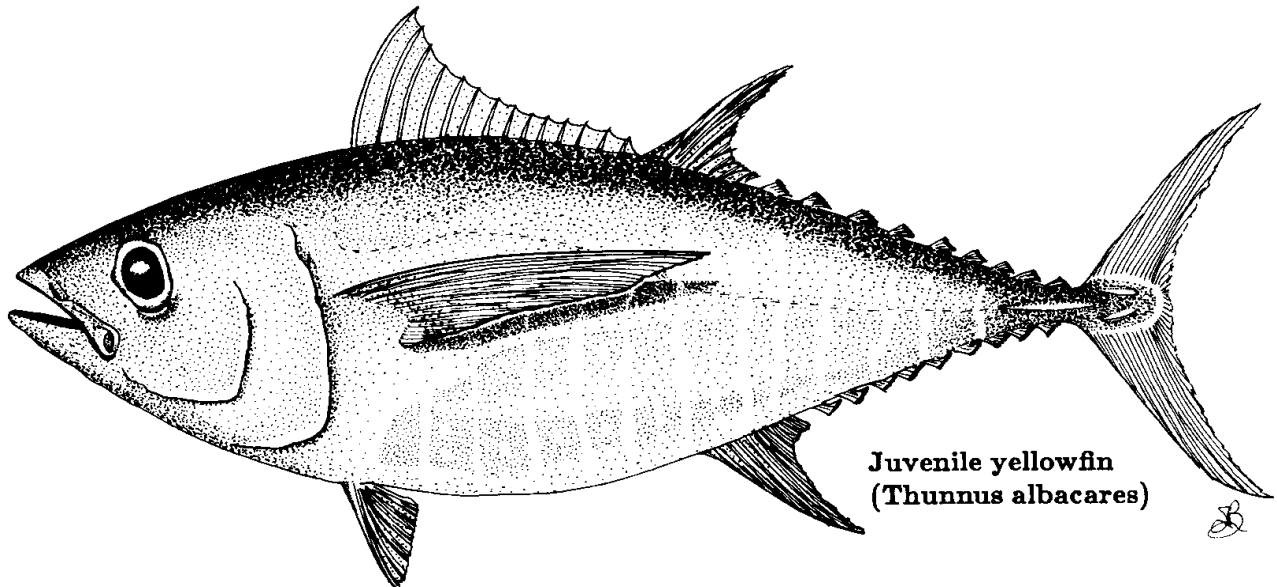

**Juvenile yellowfin
(*Thunnus albacares*)**

The three most important fish types in this group are skipjack tuna (*Katsuwonus pelamis*) and juveniles of yellowfin (*Thunnus albacares*) and bigeye (*Thunnus obesus*) tunas. Several other fish species may also be found in the same schools, and these variously include frigate tuna or frigate mackerel (*Auxis thazard*), mackerel tuna (*Euthynnus affinis*), and some non-tuna species such as dolphin fish (*Coryphaena hippurus* -see Section 7E), rainbow runner (*Elegatis bipinnulatus*), wahoo (*Acanthocybium solandri* -Section 7F), marlins (family *Istiophoridae* -Section 7M) finny scad (*Megalaspis cordyla*- Section 7M), and sharks (family *Carcharhinidae* -see Section 71).

All these species are characterised by their strong tendency to form schools, which, especially in equatorial waters, can be of very large size (tens of thousands of individuals totalling several hundred tonnes in weight). The schools may vary greatly in size, species composition, and the individual sizes of their members. Schools are often found associated with large drifting objects (trees, collections of debris, etc.), whales, or man-made FADs, and may be followed by flocks of seabirds. This too varies between locations.

The three main fish types -skipjack, and juvenile yellowfin and bigeye -make up an important, and in some countries the most valuable, part of the catch taken on open-water tuna schools, around FADs, and sometimes along the outer reef edge. Troll caught fish tend to be relatively small, usually under 10 kg (22 lbs), although this is not always the case, and much larger adult yellowfin and big eye (see Section 7C) can often be taken, especially when deep trolling. In general, however, the fisherman planning to troll on tuna schools can afford to use relatively light gear with monofilament traces down to 25 to 30 kg (55 to 65 lbs) breaking strain (but see Sections 5D, 5E and 5F). The fact that these fish are virtually toothless, and will not bite through even relatively light nylon monofilament, is a big help to the fisherman.

CHOOSING LURES

Using the lightest practicable gear is particularly important for tunas, which are visual feeders and are usually found in clear oceanic waters. They have acute eyesight, capable of detecting even small objects at a distance. These fish feed opportunistically, that is they prey on any schools of small baitfish, squid, shrimps or other surface dwelling creatures that they come across.

Because tuna feed visually, the appearance of the lure is important to fishing success. It is usually worth cutting open the stomach of the first fish caught to examine the contents. If the fish has been feeding on, for example, small pink shrimps, then small pink lures will probably be the most effective type for that day. In general, if the fish in a tuna school are feeding but not taking the lures, the lure size and colour should be changed until one type appears to be successful. Dark-coloured lures appear to be better on dark, overcast days, and light-coloured lures on bright sunny days.

Sunny days...

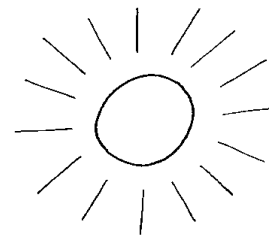

...use light coloured lures

Cloudy or rainy days...

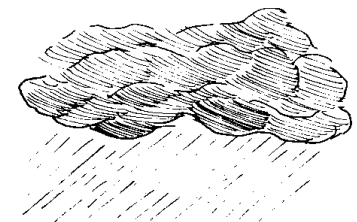

...use dark coloured lures

FEEDING SCHOOLS

The best schools for fishing are those where the fish swirl, roll, or cut the surface in a dense pack

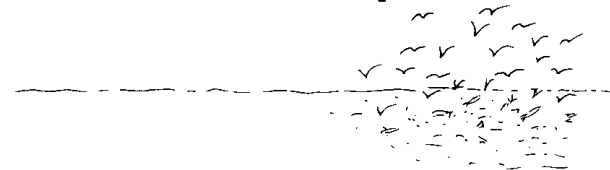

Cut fish open to see what they have been eating...

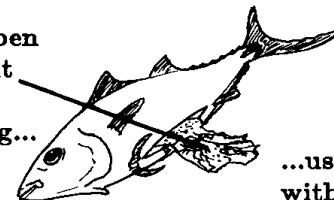

...use lures with similar colour and size

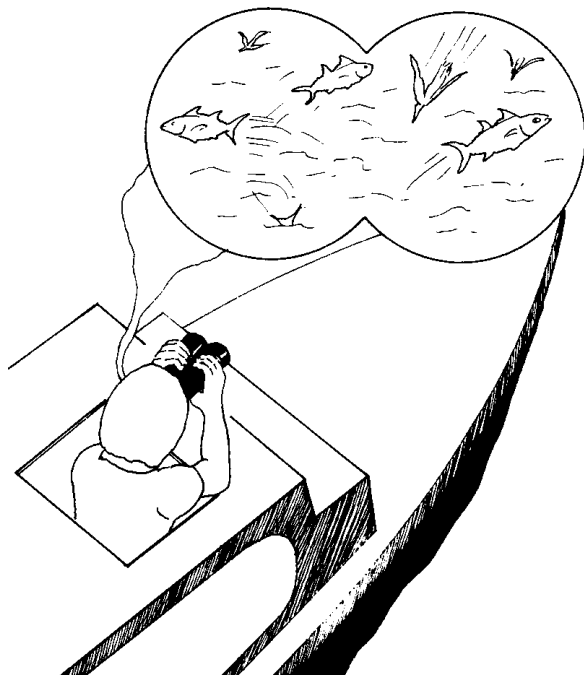

Tuna normally cruise or travel below the surface in depths of 20 m or more, but will begin to feed when they find a school of small baitfish or other prey. The prey animals normally get driven to the sea surface, where they are also attacked by seabirds. The tuna continue feeding, often for just a few minutes but sometimes for longer, attacking their prey from below, often leaping from the water in the process. The way in which these feeding fish appear depends on they are striking their prey, and has given rise to a variety of names, such as 'jumper', 'breezer', 'boiler', and 'finner', for actively feeding tuna schools.

Recognising the type of tuna school from a distance is important to the fisherman, since this helps him predict the behaviour of the fish. Although school characteristics vary from one area to another, in general the more actively the fish are leaping, the less likely they are to bite. The best fishing schools are those in which the fish swirl, roll, or seem to be packed into a small area, occasionally cutting the surface with a fin or tail.

Tuna schools are frightened by certain types of boat noise, especially from engines. Squeaking pumps or bearings, excessive vibration in the propeller shaft, and exhausts which vent below the surface make some of the noises thought to scare away tuna schools.

In the majority of cases, however, the fisherman has only a short time in which to catch most of his fish, since they are normally uninterested in attacking his lures outside of the periods of intensive feeding activity. This mean that the fishing operation must be rapid and efficient to take full advantage of the tuna's biting.

CHAPTER 7: COMMONLY CAUGHT FISH

SECTION C: LARGER TUNAS -BIG EYE AND YELLOWFIN

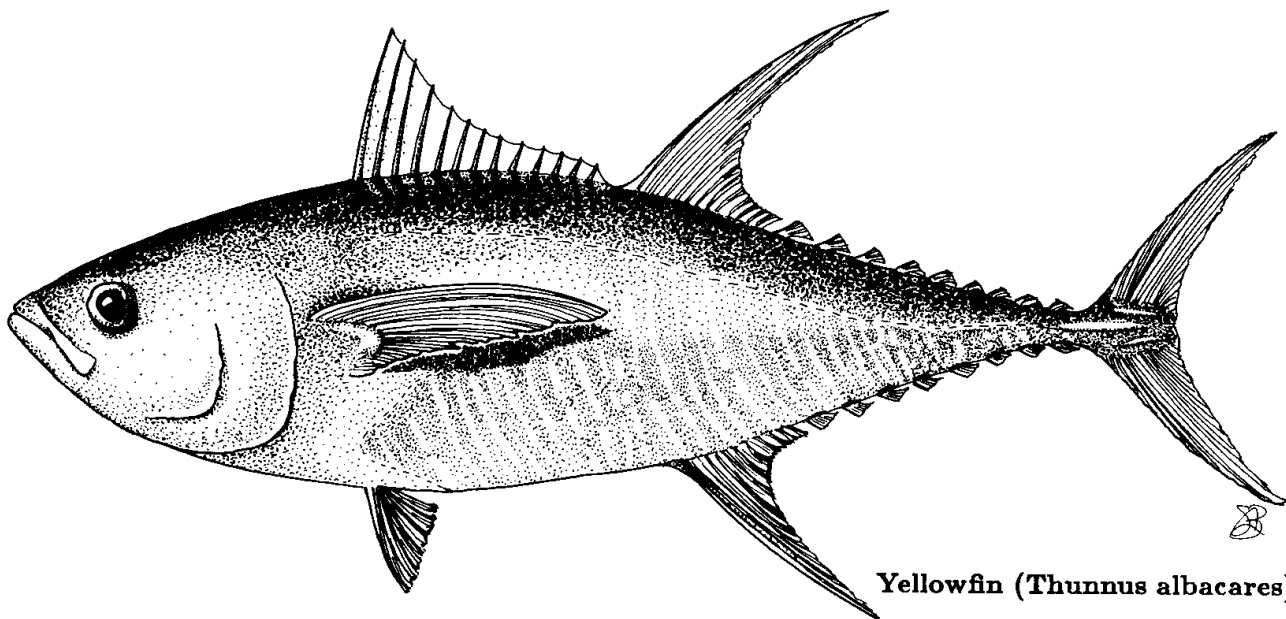

Yellowfin (*Thunnus albacares*)

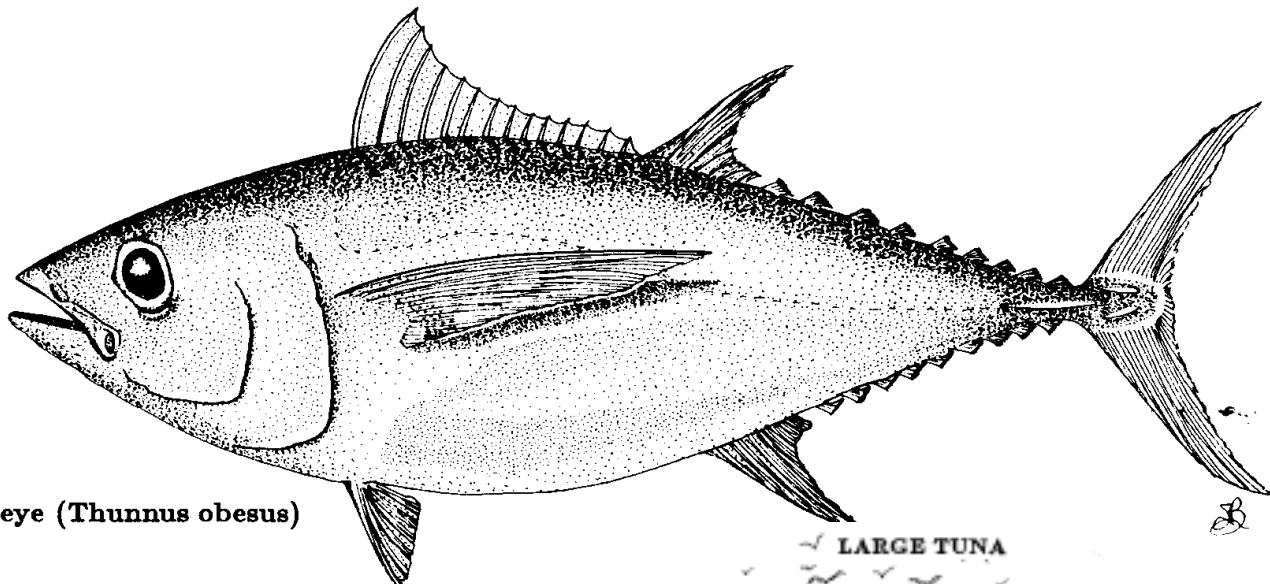

Bigeye (*Thunnus obesus*)

LARGE TUNA
When they get bigger
large tuna leave
the surface schools...

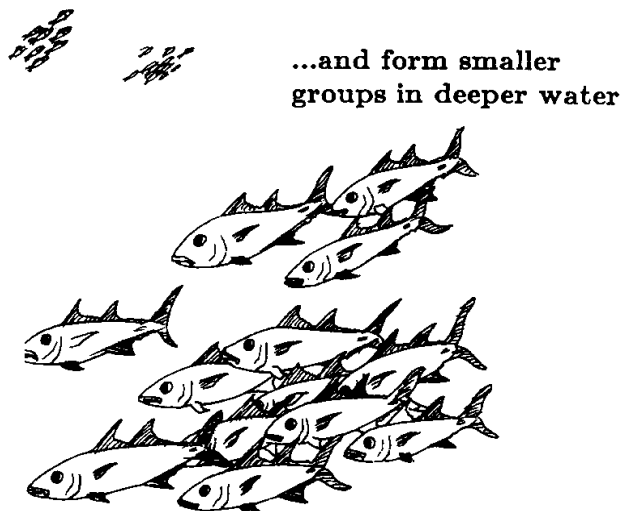

Unlike skipjack tuna, which only grow to a relatively small adult size (seldom 20 kg, or 45 lbs), yellow fin and bigeye can both reach weights of well over 100 kg (220 lbs). As the fish grow, they appear to lose their inclination to join large surface schools (see Section 7B). Instead, they form smaller groups, called 'pods', of a handful or a few dozen individuals, and these are usually found swimming in sub-surface or deep waters.

Most surface tuna schools would be expected to have one or more pods of large individuals associated with them. These are usually found swimming below the main body of the school or in its lower levels. Surface schools consisting mainly of big fish (50 to 70 kg, or 110 to 155 lbs) are sometimes found, but this is the exception rather than the rule.

So, although large tunas are sometimes taken while surface trolling, they are more liable to be caught by sub-surface or deep-trolling. Running through a tuna school with lures on heavily weighted lines, or lines fitted with diving boards, will often produce one or two 'big fellows' which would not be expected on the surface.

If larger tuna are caught on surface lines, this will often happen just after dawn or before dusk. The fish seem to move deeper when the daylight gets stronger.

DEEP TROLLING

Surface lines catch smaller fish...

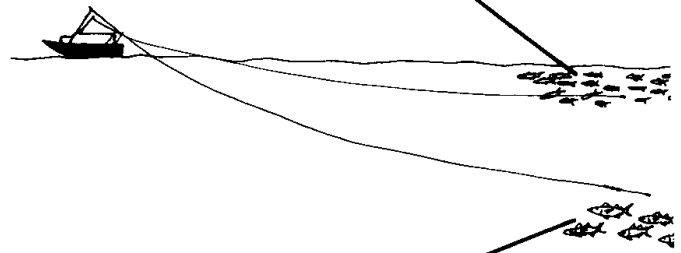

...deep lines may catch the larger ones

Pods of adult yellowfin and bigeye are also found cruising at depth along the outer reef edge. Sub-surface or deep trolling in this zone can be productive, especially around points, reef passages, offshore banks, and areas where tuna schools are frequently found. The best times are just before dawn and just after sunset.

There is some evidence to suggest that the fish follow the approximate path of a given bottom contour while swimming. Recent research in Hawaii suggests that large bigeye and yellowfin swim along the 70 metre (40 fathom) bottom contour, which corresponds to the lower levels of the 'mixed' layers of surface ocean waters. A possible fishing strategy might therefore be to try to follow the depth contour where a strike occurred.

FOLLOWING CONTOURS

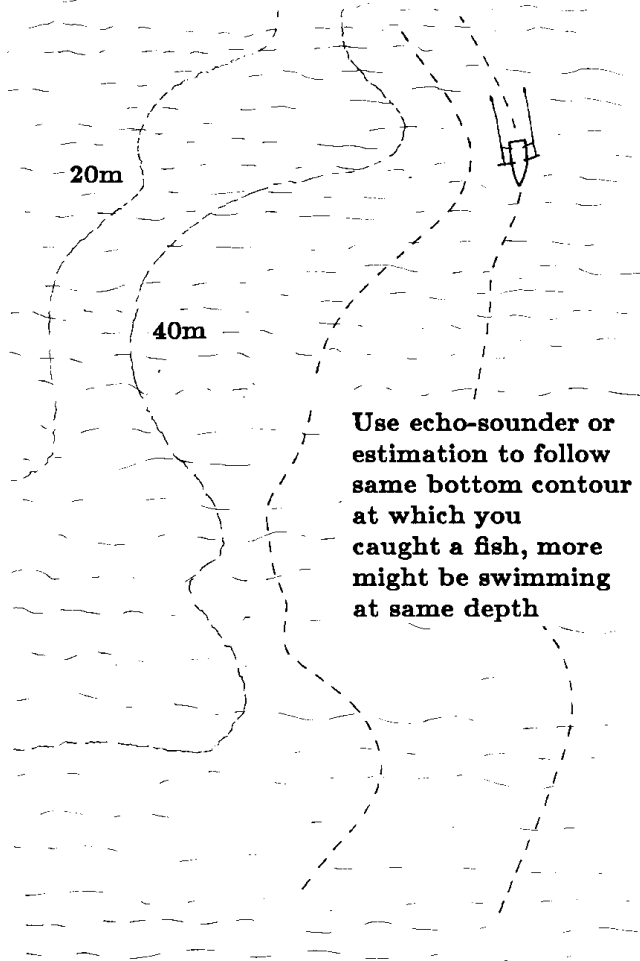

FADs

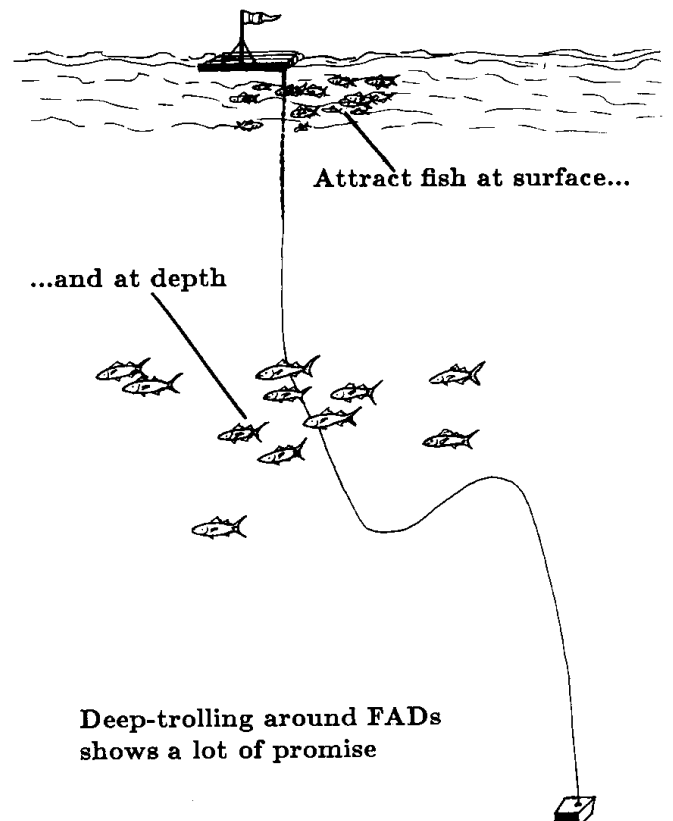

One of the most significant developments in Pacific fisheries in recent years is the widespread use of fish aggregation devices, or FADs (see Section 5F) to attract and hold surface schooling tunas in a given area. However, it is only now being realised that FADs seem to be at least as effective, and maybe even more so, in aggregating deep-swimming tunas. Very little work has so far been done to test the effectiveness of deep-trolling around FADs, but the potential appears to be there, and this is a fishery which shows promise for the future.

CHAPTER 7: COMMONLY CAUGHT FISH

SECTION D: DOGTOOTH TUNA

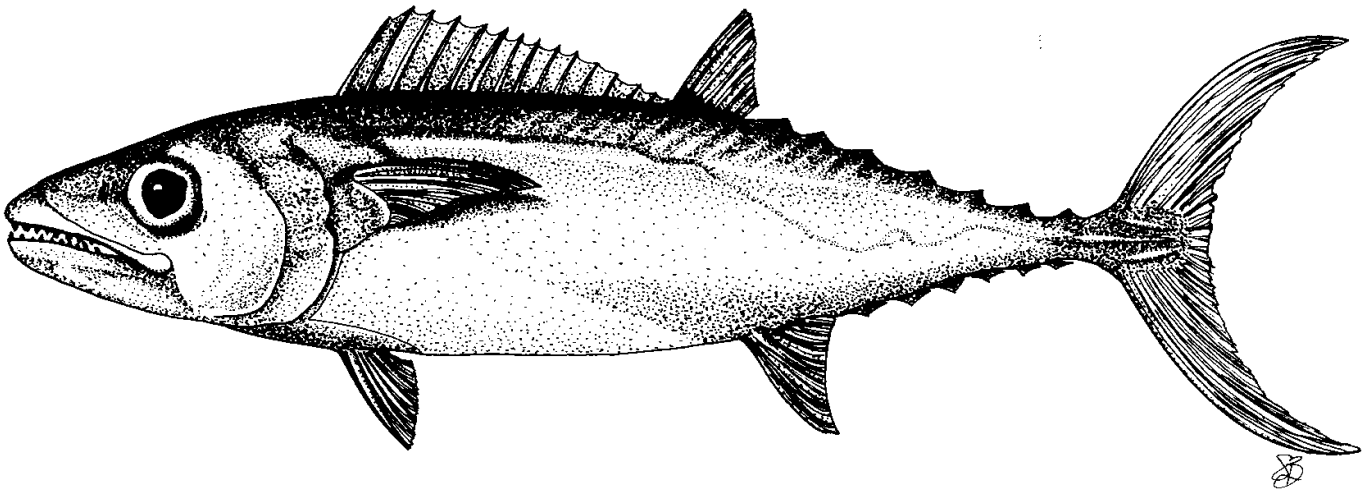

Dogtooth (*Gymnosarda unicolor*)

Unlike the other tuna species found in the Pacific, the dogtooth (*Gymnosarda unicolor*) is not free-ranging in its habits, but lives in association with barrier and offshore reefs. It forms small pods or groups of a few individuals, and, though not aggressive, is curious about divers, often approaching them closely to investigate them. Dogtooth flesh is light pink or nearly white, not red and bloody like that of most other tunas. This species can attain weights of over 130 kg (285 lbs), but 30 kg (65 lbs) or less is more usual.

The areas around reef passages seem to be favourite haunts of dogtooth tuna, and they are often taken there, especially at first and last light. Whenever a dogtooth is caught, it is almost certain that more are in the same area. Circling the spot will frequently produce one or more subsequent strikes, often before the first fish has been boated. However, even moderate fishing pressure will rapidly deplete local dogtooth populations, and initial high catches are unlikely to be maintained.

PASSAGES

Dogtooth are often found in passages

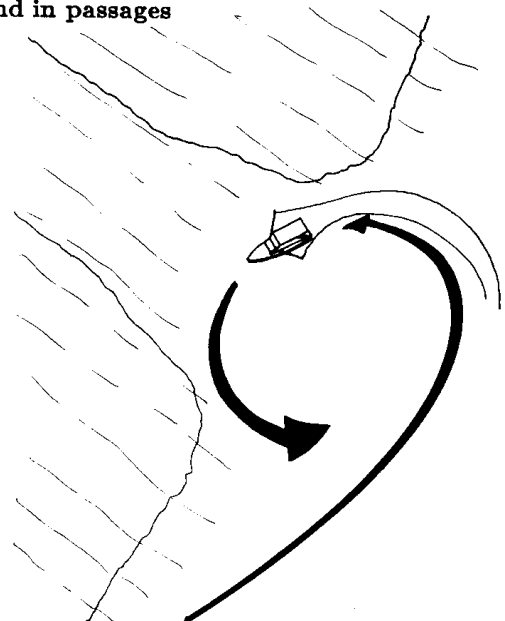

Circling in the pass after catching a dogtooth will often produce more

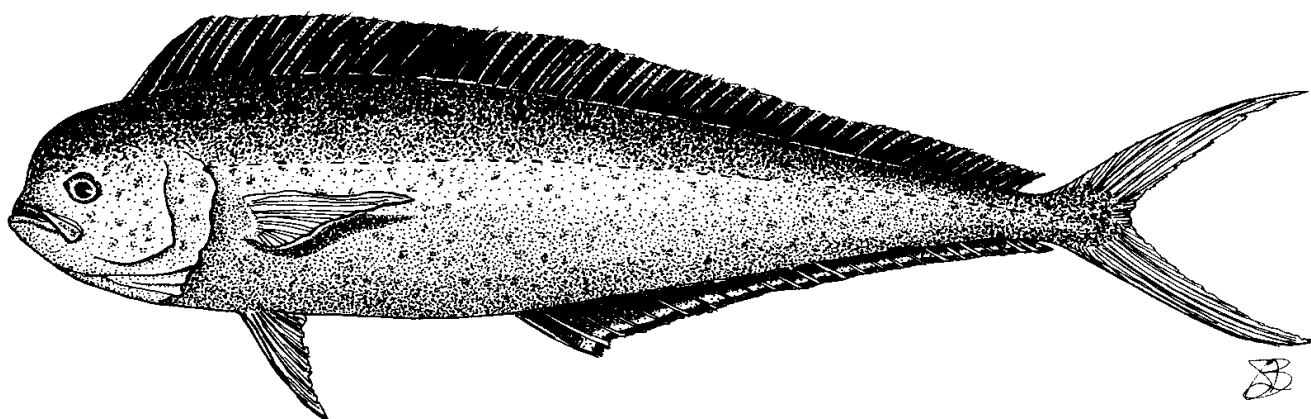

Dolphin Fish (*Coryphaena hippurus*)

The dolphin fish (*Coryphaena hippurus*), also known as mahimahi and dorado, is an offshore pelagic species which can attain weights of over 50 kg (110 lbs), although 15 kg (33 lbs) or less is more usual. Adult males are distinguished by their large hump-like forehead. The fish are a brilliant yellow-green in life, but undergo vivid colour changes, through electric blue and pearly white, after being boated.

This species forms schools which can consist of just a few or of many hundred individuals. The schools are often mixed with tuna and associated species, and are frequently followed by birds. Dolphin fish seem especially fond of following floating objects as they drift, and are usually to be found in numbers around fish aggregation devices, where they are often the first fish to strike.

Dolphin fish have a distinctive striking behaviour. They can often be seen when they first sight the lure from a distance: the fish 'lights up' an electric blue and streaks through the water, with its forehead and dorsal fin above the surface, to attack the lure. The strikes are almost always from the side, rather than from behind or ahead. The dolphin fish will sometimes keep on going in the same direction after being hooked, leaping over other lines before reversing direction and swimming back under them. Dolphin fish are notorious line-tanglers, especially when two or more strike at the same time.

When a dolphin fish is hooked and hauled in, other fish from the same school may follow it right up to the stern of the boat. Rather than bring this first fish aboard immediately, some fishermen tie off the line so that it is towed just behind the stern. This keeps the school close to the boat and allows the following fish to be hooked and brought in rapidly using very short lines. This method sometimes allows the fishermen to 'clean up' the entire group of following fish, although there is always the chance that the first fish hooked -which is often the biggest -will break off and be lost.

'HOSTAGE' FISHING

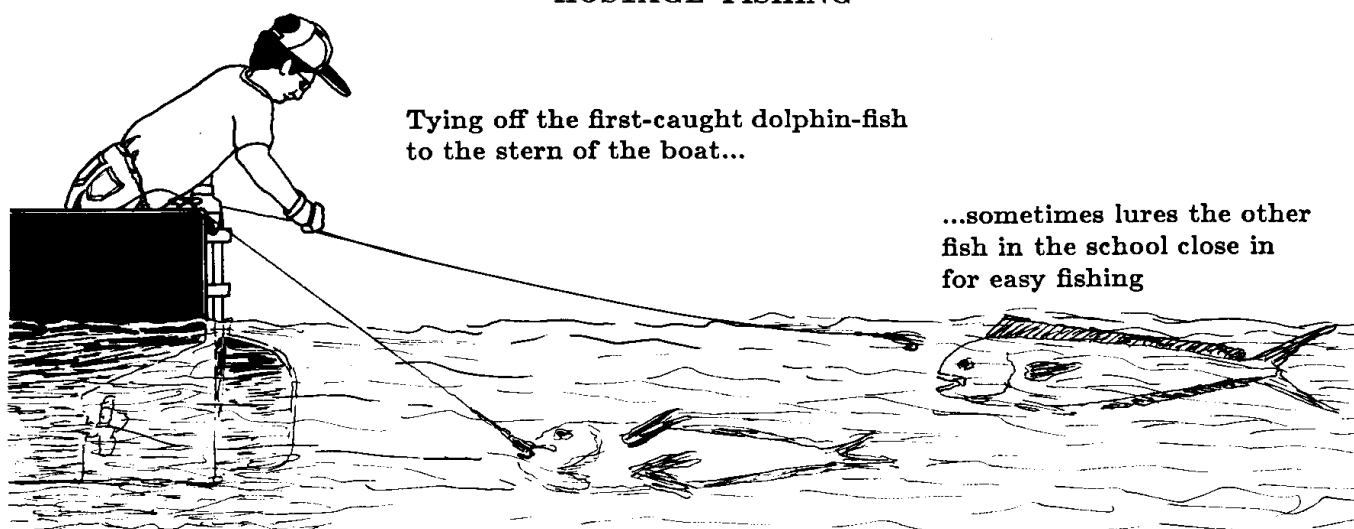

**Tying off the first-caught dolphin-fish
to the stern of the boat...**

**...sometimes lures the other
fish in the school close in
for easy fishing**

CHAPTER 7: COMMONLY CAUGHT FISH

SECTION F: WAHOO

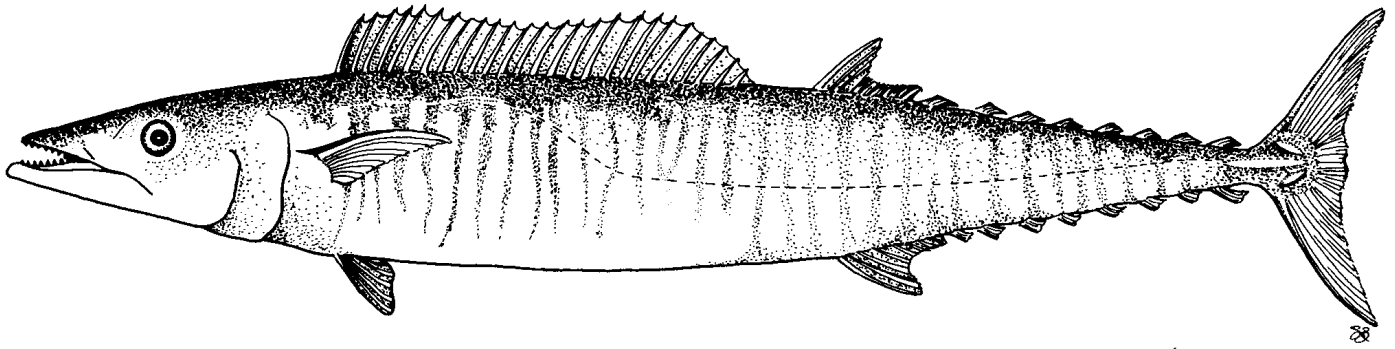

Wahoo (*Acanthocybium solandri*)

The wahoo (*Acanthocybium solandri*) is a free-ranging pelagic species found both close to barrier reefs and coastal areas, and many miles offshore. It tends to be solitary or form loose aggregations of small numbers of fish, rather than schooling in the true sense of the word. It is a seasonal fish in most areas outside the equatorial zone. Trolling success for wahoo is often related to the state of the tide, especially when fishing close inshore. The maximum size is over 80 kg (175 lbs), but fish are more commonly in the 10-30 kg (22 to 65 lbs) range.

Wahoo are highly prized sport fish, much sought after by big game fishermen because of the excellent fight they put up when hooked. This species is one of the fastest fish in the ocean, and will swim for short periods of time at speeds of over 50 knots (75 km/hour). It is a voracious feeder with razor sharp teeth that cause heavy damage to bait and lures. Wire or cable traces are essential when catching this species, as with so many fish, natural baits are often more effective than artificial lures when wahoo trolling.

Wahoo can sometimes be found basking at the sea surface, apparently asleep. If surprised by an approaching boat, they will 'light up' an electric blue colour, and dart away. However, by drifting or paddling quietly, a small boat with its engines off may be able to approach the fish close enough to spear or harpoon it, or even gaff it aboard.

BASKING WAHOO...

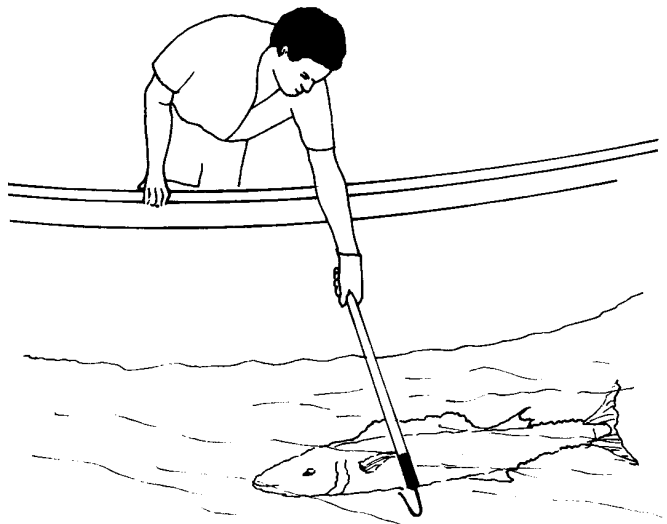

...can sometimes be harpooned or gaffed aboard while they are 'sleeping'

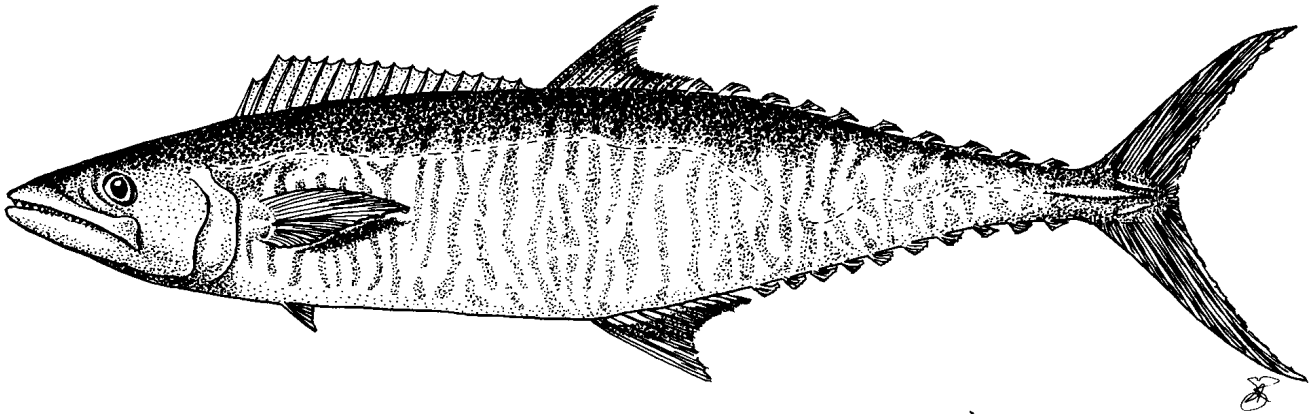

Spanish mackerel (*Scomberomorus commerson*)

This species (*Scomberomorus commerson*) is found in the western Pacific, as far east as Wallis (Uvea) Island. Several other related *Scomberomorus* species occur around Australia and in the gulf waters of Papua New Guinea, but do not extend significantly into the Pacific islands region.

Spanish mackerel is found year-round where it occurs, but there is a distinct season during the warmest months of the year, when it is caught in much greater numbers than at other times. Fish are taken both inside lagoon areas, and along the drop-off of barrier reefs, where larger numbers and bigger individuals are usually caught. Reef passages can also be productive areas for this species.

Spanish mackerel form aggregations which may contain from a few to a couple of hundred individuals. A 'standard' bait is small garfish rigged on two or three ganged hooks, as shown in Section 4D, and this is trolled just below the surface using a weighted line. When a strike occurs, more strikes can usually be encouraged by pulling in or jiggling the other trolling lines as the first hooked fish is being hauled. Sometimes, one or more of its fellows will follow the first hooked fish right up alongside the boat as it is hauled in.

Large individuals of Spanish mackerel have been demonstrated to be ciguatoxic (carrier of fish toxicity) in some localities, and this may be true throughout their range. For the most part, however, this is not a problem and Spanish mackerel are prized eating fish in most places where they occur.

CHAPTER 7: COMMONLY CAUGHT FISH

SECTION H: BARRACUDA AND SEAPIKE

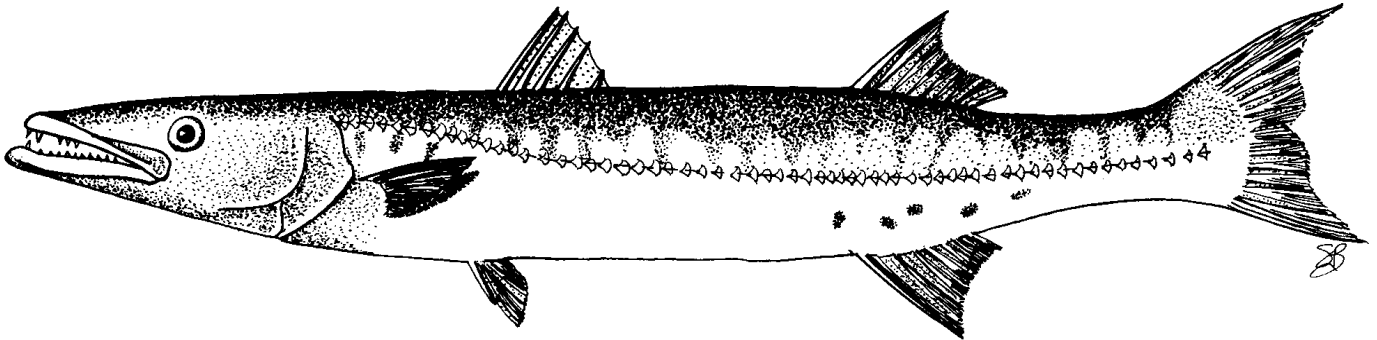

Great barracuda (*Sphyraena barracuda*)

There are several species of the genus *Sphyraena* normally caught trolling. In general, small individuals a metre or less in length are referred to as seapike, larger individuals as barracudas.

The true or great barracuda, *Sphyraena barracuda*, is found in both inshore and offshore waters, the largest individuals (which can be over 60 kg (135lbs)) being solitary and oceanic in nature. This species is day-active and may be caught trolling even during the middle of the day, when other species often do not bite.

A second species which also reaches large sizes is the slender sea-pike, *Sphyraena jello*. This species is only found in coastal areas and not in offshore waters. The slender sea-pike is the species of barracuda most often implicated in attacks on divers and swimmers. However, it appears to be principally a night-feeder and is usually caught when lagoon-trolling at dawn and dusk, rather than during the daytime.

Several other species are also found, almost exclusively in inshore waters, none of which usually exceed 10 kg (22 lbs) in weight. Most seapike and barracuda species have been implicated in cases of ciguatera fish poisoning at some time or another. In locations where ciguatera is a problem, it is safest not to eat fish over 5 kg (11lbs) in weight. These can be used instead for bait as shown in Sections 4E and 4F.

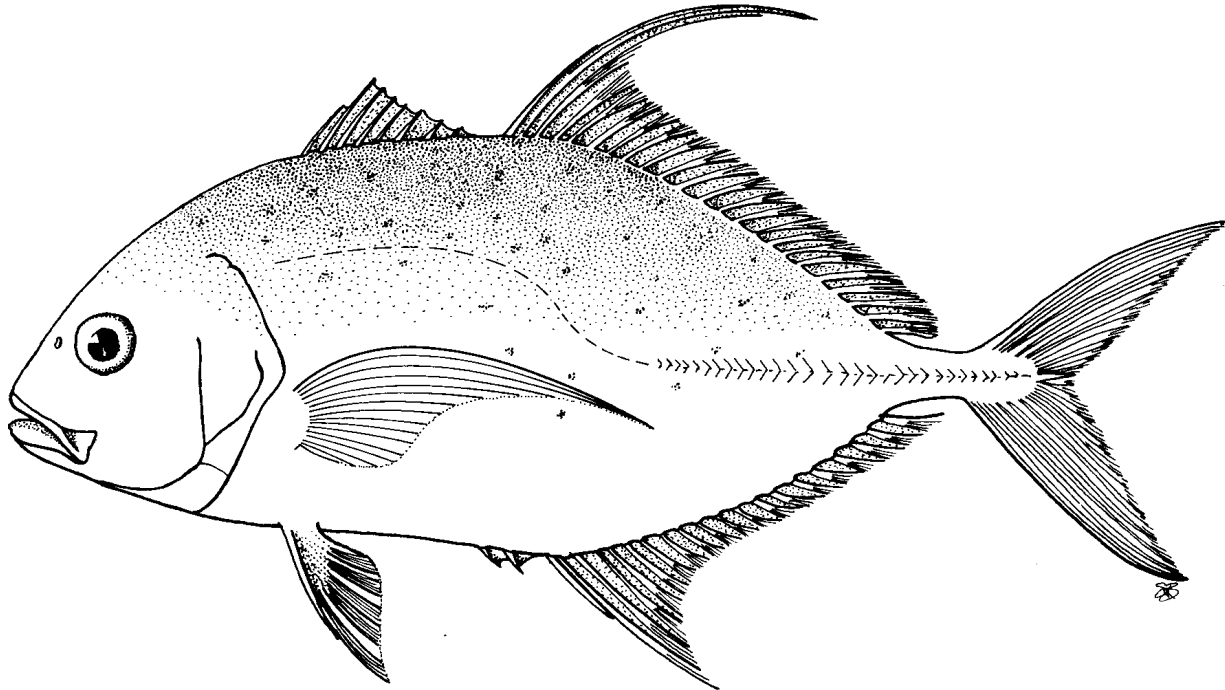

Trevally (*Caranx ignobilis*)

Many different species of trevally in the genera *Caranx* and *Carangoides* are found throughout the tropical Pacific islands, and most are susceptible to being caught by trolling. Some, such as the giant trevally (*Caranx ignobilis*) and black trevally (*Caranx lugubris*) attain sizes up to about 50 kg (110 lbs) and 20 kg (45 lbs) respectively. For the most part, however, trevallies weigh in at 10 kg (22 lbs) or much less.

Almost all trevally species are coastal or inshore in their habitat. Many species form schools of scores of individuals which may feed voraciously at times. Very large individuals, however, tend to be solitary or travel in very small groups.

Most trevallies are predatory, feeding on small reef-associated fish or other marine animals. They are most often caught trolling using small lures, especially metallic spoons or spinners. In general, trevallies have very small teeth and are not usually capable of biting through a nylon line.

CHAPTER 7: COMMONLY CAUGHT FISH

SECTION J: DOUBLE-LINED MACKEREL

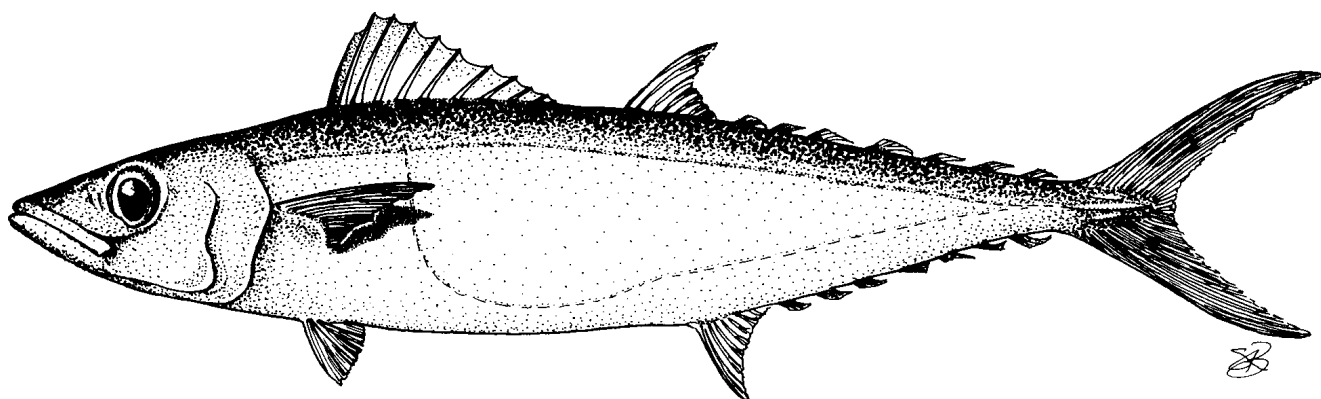

Double-lined mackerel (*Grammatocynus bicarinatus*)

It is now recognised that there are two species of double-lined mackerel (also called shark mackerel), although until recently both were thought to be the same. The true double-lined mackerel, *Grammatocynus bicarinatus*, is the larger of the two, reaching a maximum weight of at least 15 kg (33 lbs). Its range is thought to be restricted to the western Pacific ocean, but several reports from countries as far east as Tokelau dispute this. The smaller species, *Grammatocynus bilineatus*, or mackerel scad, reaches much lower maximum weights of 3-4 kg (6-9lbs). It is distributed Pacific-wide and, like the double-lined mackerel, occurs in inshore and lagoon waters.

Both species can be taken by trolling small feather or octopus lures in coastal areas, and are excellent themselves as trolling bait for bigger fish (see Sections 4B and 4E).

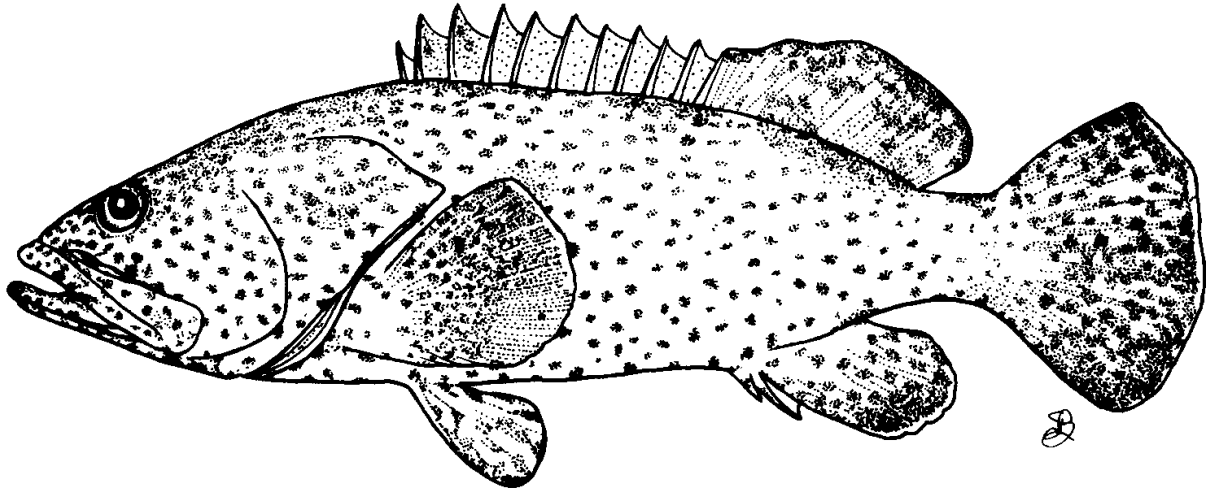

Grouper (family Serranidae)

Coral trouts and groupers (family *Serranidae*) are a diverse group of fish, comprising very many different species, all of which live in association with coral reefs, or on reefy or rocky bottoms in coastal areas. The coral trouts tend to be more pelagic in nature and are more often taken by trolling than the related groupers, which tend to be slower-swimming and to feed among the rocks and coral.

Coral trouts and groupers are usually caught when surface or sub-surface trolling close in to barrier and offshore reefs. They will usually attack large, brightly coloured, active lures such as Smiths jigs, although many other baits and lures are also effective.

In some areas, these fish are highly favoured by the local market, while in others they have been convincingly implicated in cases of ciguatera fish poisoning. In areas where ciguatera is known to be a threat, specimens over 5 kg (11lbs) should not be eaten.

CHAPTER 7: COMMONLY CAUGHT FISH

SECTION L: SHARKS

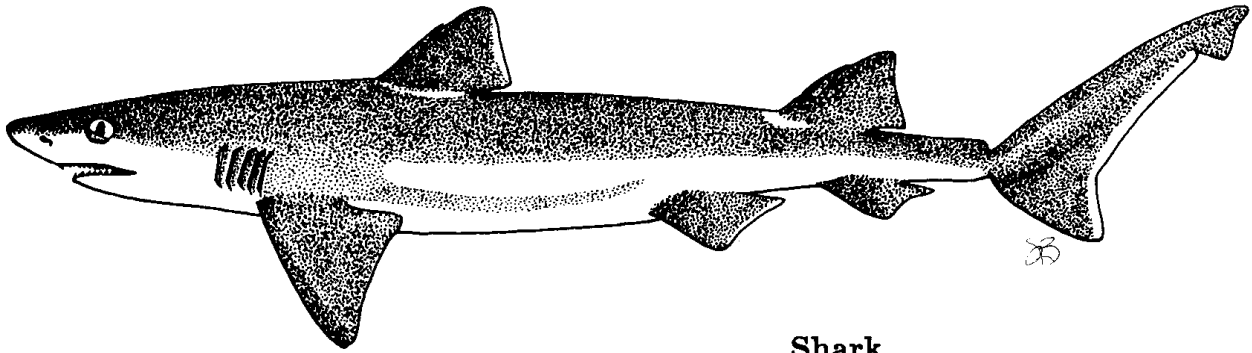

Shark

Sharks are more of a nuisance than a target species to most troll fishermen. They are not usually caught directly, as they will seldom attack a trolling lure, although some species will sometimes attack a natural bait. However, they are sensitive to the panic signals emitted by a hooked fish, and will often move in to attack it before it can be boated. In some cases, the shark becomes hooked itself, but more often than not it eats most or all of the hooked fish without being caught. Since the largest fish usually take the longest time to bring into the boat, these are often the ones which are lost to shark attack, a fact which is doubly frustrating to the fisherman.

Sharks can be a real nuisance when tuna-trolling, especially around FADs, where substantial resident shark populations seem to build up. Since tuna-trolling often relies on the use of monofilament nylon lines to be fully effective, an attack on a hooked fish by a shark usually results in the line being bitten through, and the consequent loss of the lure. If this is happening too frequently, there is usually no choice other than to switch to wire lines to save gear, even though this will reduce the strike rate by the tuna.

One way to reduce the shark nuisance is to rig several large single hooks on short wire or cable traces, and to the other end of each fix a block of wood, a bottle, or some other floating object. When sharks start to attack your trolled fish, bait the hooks and throw them overboard with the floats attached. The sharks will often attack and swallow the baits, and from then on have to contend with a piece of wood or a bottle hanging from its mouth. This will usually prevent it from attacking your trolled fish, at least for a while, and may ultimately cause the shark to die of starvation.

TO GET RID OF SHARKS

Rig single hooks on floats or old bits of wood...

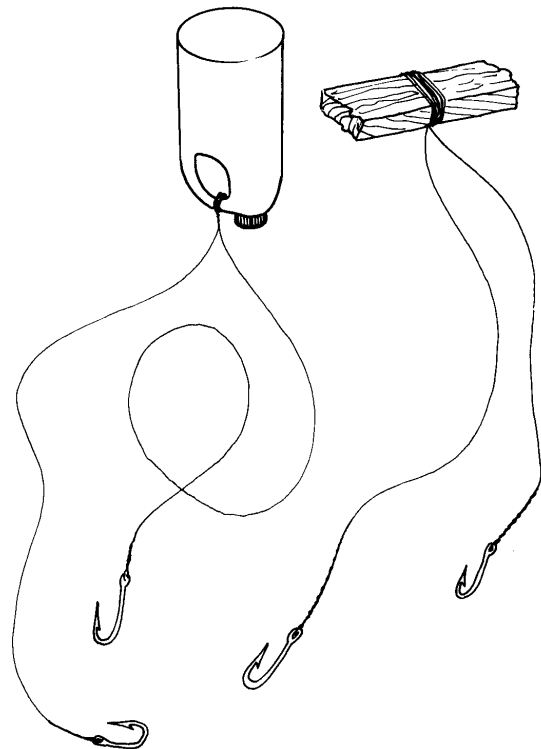

...bait them and throw overboard to occupy sharks

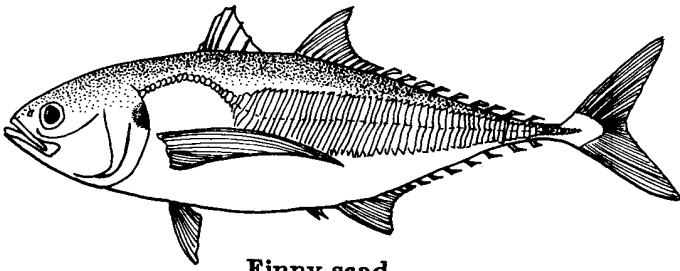

Finny scad
(*Megalaspis cordyla*)

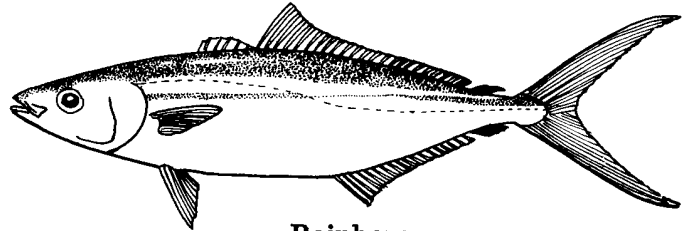

Rainbow runner
(*Elegatis bipinnulata*)

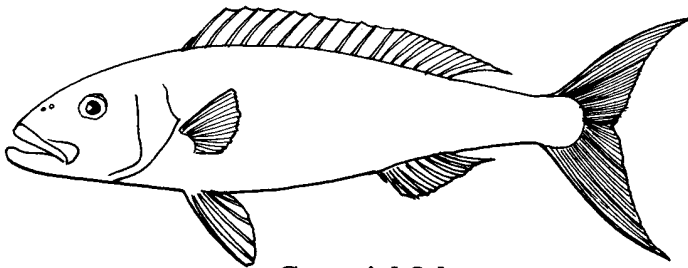

Green jobfish
(*Aprion virescens*)

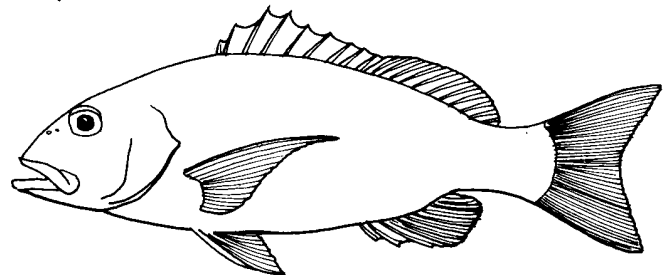

Red sea bass
(*Lutjanus bohar*)

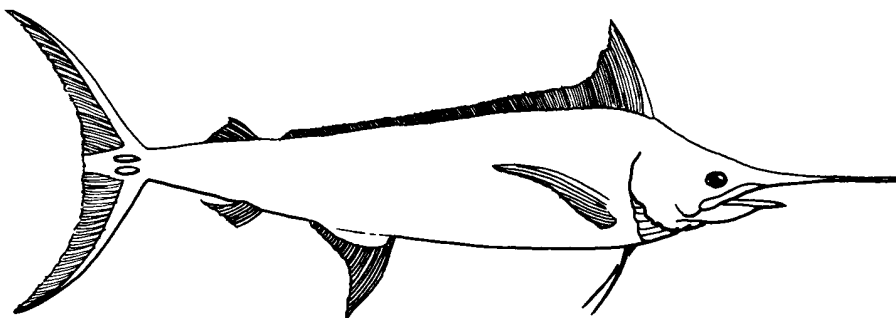

Striped marlin
(*Tetrapturus audax*)

A wide range of other species, not already referred to, can often be caught trolling. These include various reef associated snappers, especially the red sea bass (*Lutjanus bohar*) and the green jobfish (*Aprion virescens*): several non-trevally carangids, particularly the pelagic rainbow runner (*Elegatis bipinnulatus*), and some inshore species such as the finny scad (*Megalaspis cordyla*): and the oceanic billfish group -spearfish, swordfish, sailfish and marlins. All these species can be important parts of the catch in certain localities, or in particular specialised fisheries. However, on a region-wide basis, they are less important than the species already discussed.

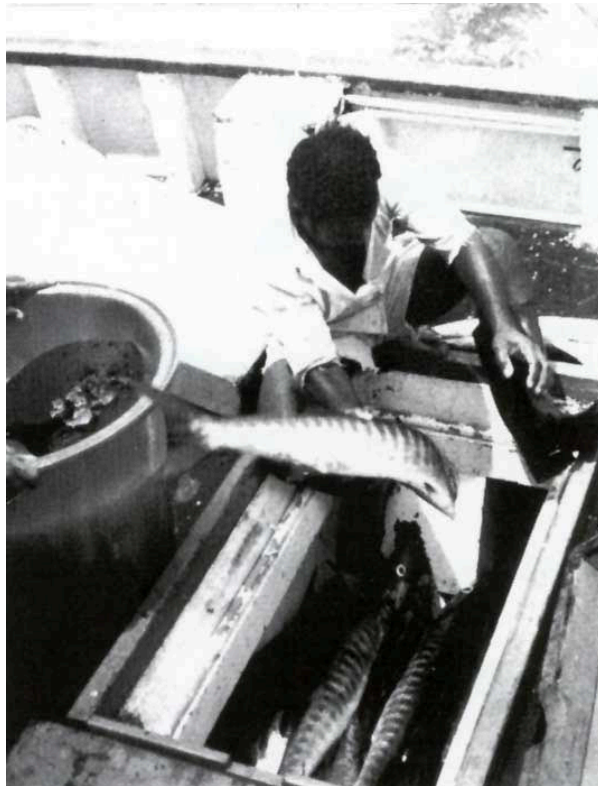

Location: Great Sea Reef, Fiji

Photo: L.B. Chapman

On board icing down of the catch

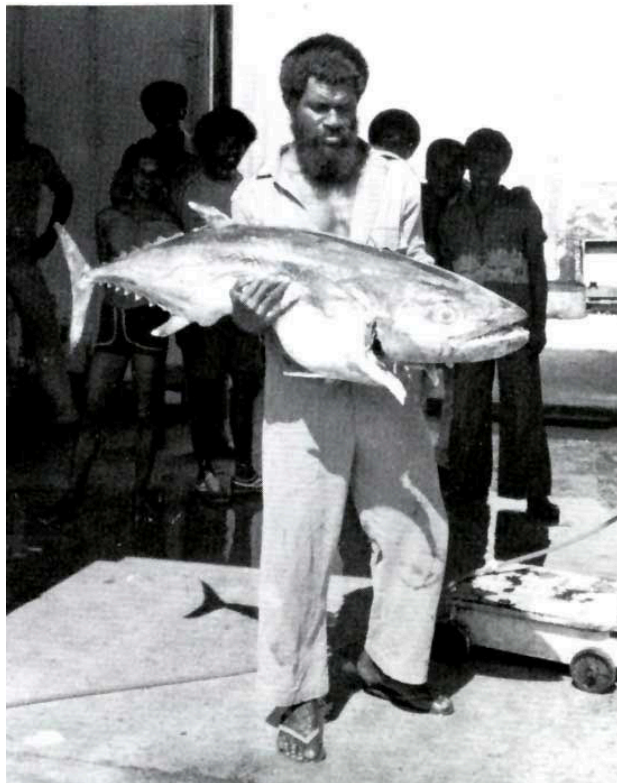

Location: Lautoka, Fiji

Photo: L.B. Chapman

A good-sized dogtooth caught trolling

CHAPTER 8

AFTER FISHING

- A. CARE OF THE BOAT *-General cleaning -Cleaning metal fittings -Engine maintenance
-Hull maintenance -Repairs*
- B. CARE OF THE FISHING GEAR *-Cleaning -Hooks -Joints -Lines -Lures -Storage*
- C. CARE OF THE CATCH *-Cleaning and icing -Unloading -Disposal*
- D. KEEPING RECORDS *-Engine hours -Fuel consumption -Catch -Profit and loss*

CHAPTER 8: AFTER FISHING

SECTION A: CARE OF THE BOAT

Commercial-style fishing is an activity which places heavy demands on a small boat and its equipment. The thrashing of heavy fish can cause a lot of damage to paintwork, fittings, and deck equipment. Fish slime and blood will stick to surfaces, making them slippery and dangerous. Scales and scraps of fish waste will collect in bilges and corners, blocking pipes and drains and making the boat foul. Salt spray will accumulate everywhere, causing electrolysis or corrosion of metal fittings and making moving parts such as hinges and joints size up. A general deterioration of the boat will occur unless it is properly cleaned at the end of every day's fishing, and receives some basic maintenance each time it returns to port at the end of a fishing trip.

General cleaning

At the end of the day, or during a lull in the fishing, throw a bucket of sea water over the decks and interior surfaces of the boat, and clean off any patches of blood or slime with a stiff brush or a rag. Bale or pump out the bilges and pick out any pieces of waste fish which may be in there.

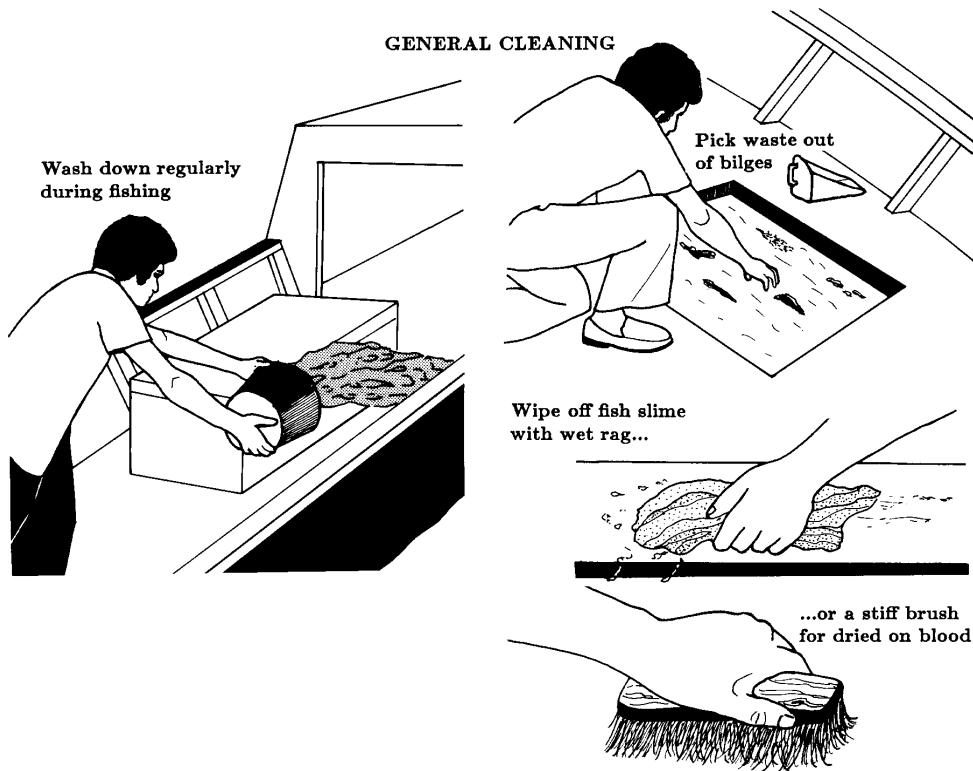

METAL FITTINGS

Wash with fresh water to prevent excess rusting

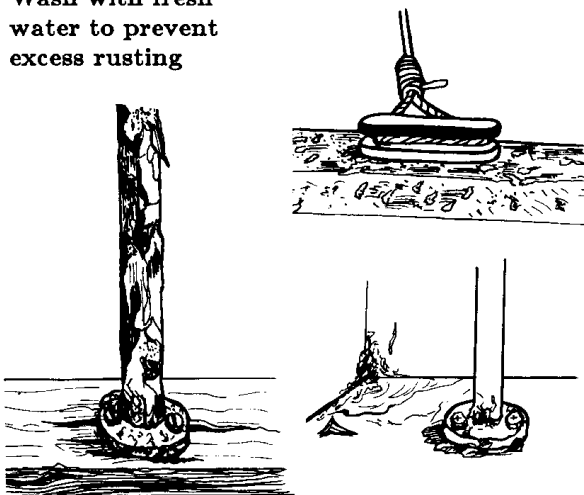

Cleaning metal fittings

When the fishing trip is over, wash or wipe down any metal fittings or moving parts using fresh water. This will remove salt and fish scales and help prevent the fittings from rusting up, jamming, or developing dangerous rough or jagged edges.

Engine maintenance

When the fishing trip is over, wipe or wash the exterior surfaces of the engine with a rag dipped in fresh water, once the engine has cooled off. When it dries, wipe it with an oily rag or spray with light lubricant oil for protection. Treat any moving or corrosion-prone metal fittings in the same way. Use a grease gun to grease up the grease nipples or cups on the motor after every trip.

If the engine is an outboard, flush the engine cooling system with fresh water if possible. This can be done by removing the engine from the boat and running it in a drum of fresh water. If the outboard is permanently mounted on the boat, use a commercially available (or improvised) flushing device, fitted on to a water hose, to supply fresh water to the engine cooling intake.

OUTBOARD ENGINES

Always flush with fresh water...

...run it in a drum of fresh water...

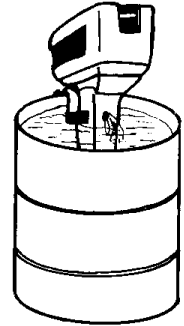

...or use a flushing device...

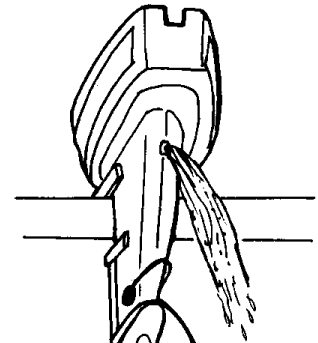

...to flush it on the boat



Hull maintenance

The build-up of weeds, barnacles and worms on the hull below the waterline will increase your fuel consumption greatly and in wooden boats may lead to serious damage by borers or rot. Repaint the hull with antifouling paint every 9 - 12 months or as often as necessary. In between times, keep the hull clean by brushing or scraping, being careful not to damage the paint surface.

MAKE A LIST...

...of things you need to fix...

...then fix them!

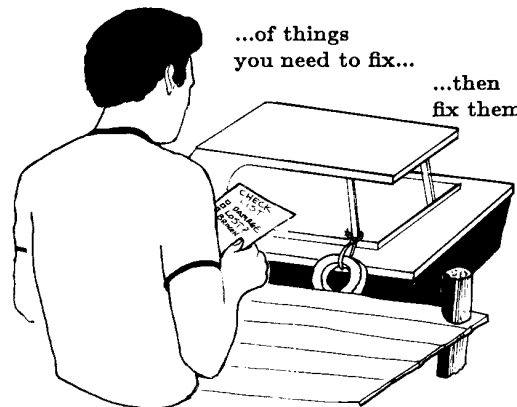

INBOARD ENGINES

Oil chains and moving parts

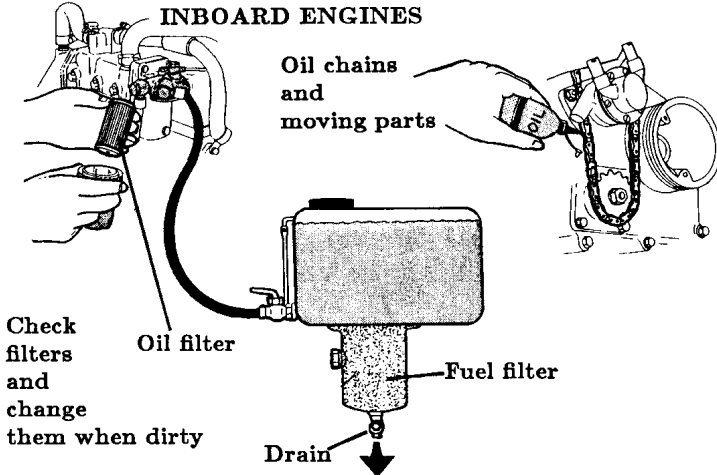

Check filters and change them when dirty

Oil filter

Fuel filter

Drain

OUTSIDE HULL

Regularly scrape or wipe off weed or shell growth on hull...

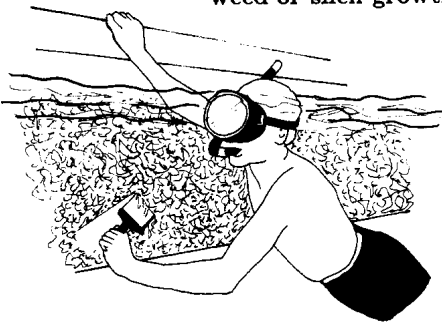

...but be careful not to scrape off the anti-fouling paint too

Repairs

When the fishing trip is over, make a note of any damage which may have occurred - broken booms, lost deck equipment, etc. Carry out repairs or replacement as soon as possible, before the damage is forgotten about, or becomes serious or dangerous.

CHAPTER 8: AFTER FISHING

SECTION B: CARE OF THE FISHING GEAR

Like the boat, the fishing gear suffers damage and deterioration during use, and after the fishing trip needs to be cleaned, maintained, and where necessary repaired.

Cleaning

Wash all fishing gear in fresh water to remove encrusted salt. Scrape off any adhering blood and slime, and ensure the gear is properly dried before storage.

Hooks

Check all hooks to make sure they are sharp and have not been bent. Sharpen blunt hooks as shown in Section 3C. Straighten or replace bent hooks, or those which are too badly rusted.

Joints

Examine knots, twists, end loops and sleeves to make sure they are not slipping or coming undone. Cut out and repair any which are.

Lines

Check over lines for abrasion, kinks, knots, rusting or other damage. Repair or replace sections which appear to have been significantly weakened.

Lures

Clean rust and tarnishing from metallic lures, and touch up badly damaged paintwork on hard lures as described in Section 41. Add more skirt material to badly torn octopus lures, as shown in Section 4G.

Touch up painted lures...

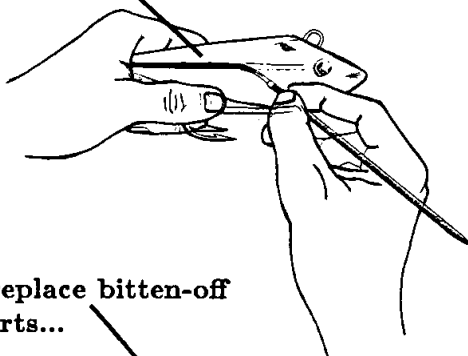

...replace bitten-off skirts...



CARE OF GEAR

After fishing wash gear in fresh water...

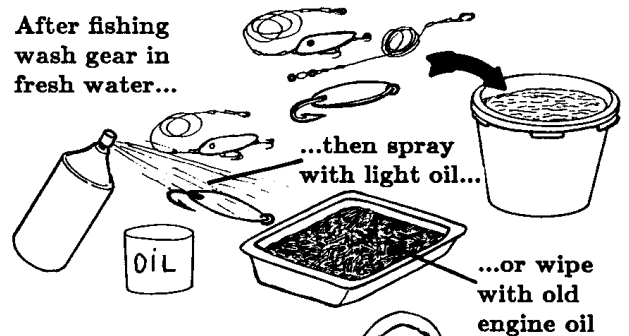

Check your hooks...

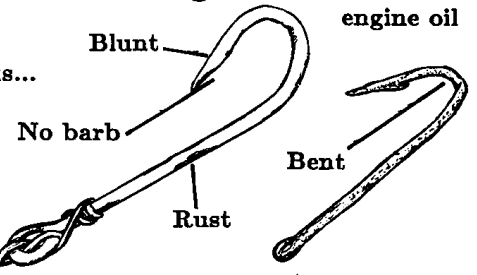

...and clean or sharpen them

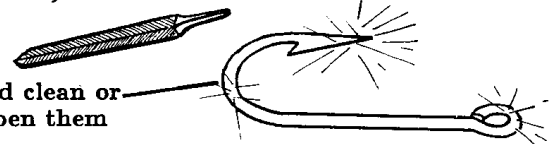

Check lines for damage

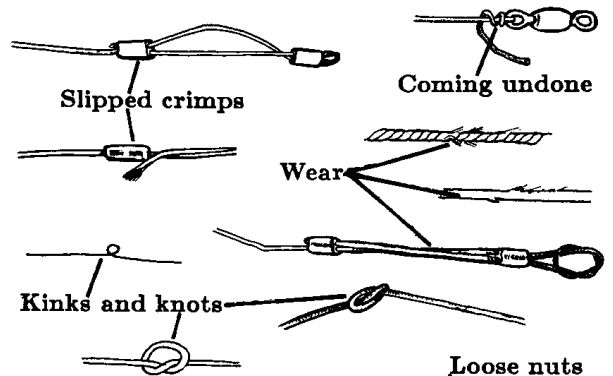

...change hooks when needed

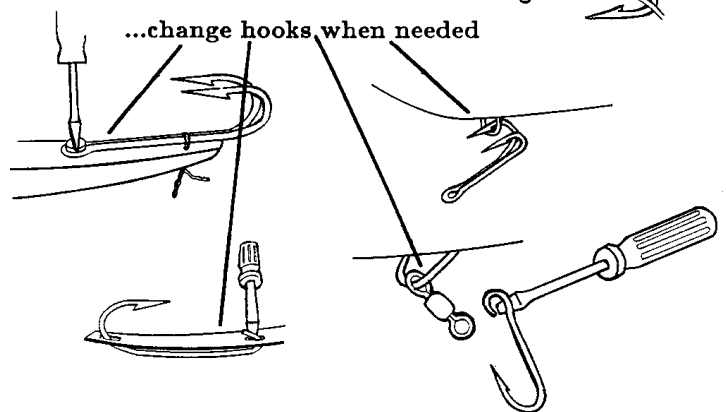

Taking care of the fish caught should start as soon as they are boated (see Section 6G) and should continue until they have been sold or otherwise disposed of.

Cleaning and icing

At intervals during the fishing, and at the end of the fishing day, make sure that all fish have been cleaned and iced if this is the normal practice. If the fish have been in the ice box for some hours or days, check to make sure that the ice and fish are still well-mixed together. Repack the icebox if necessary.

Unloading

When unloading the fish from the boat, handle them carefully to avoid bruising and damage. Carry fish in bags or boxes, preferably mixed with some ice. Do not throw them, drag them or walk over them. Try not to drop them on the ground, or leave them lying in the sun. Do not wash fish in dirty or polluted harbour water, or let animals sniff around them. Pay attention to quality, and you will usually be rewarded by better prices and a better reputation.

Disposal

When the fishing trip is over, dispose of the catch as soon as possible. Do not leave the fish in storage in the boat's ice box any longer than is needed. If it is necessary to do this, check the fish daily to ensure there is still enough ice. Repack or add more ice when required.

ICING DOWN



Use as much ice as possible

Carry fish in boxes

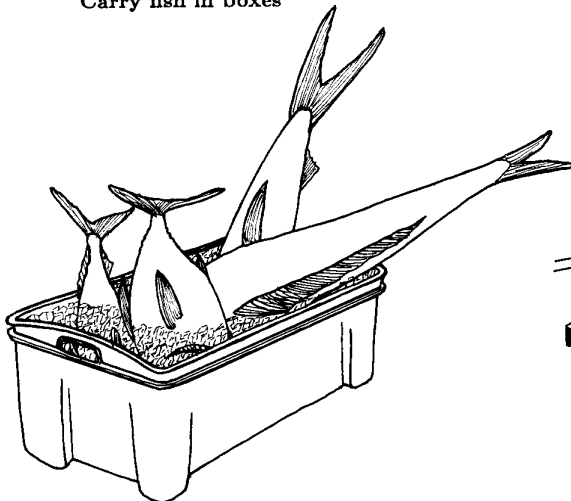

CARE OF THE CATCH

Unload fish carefully...

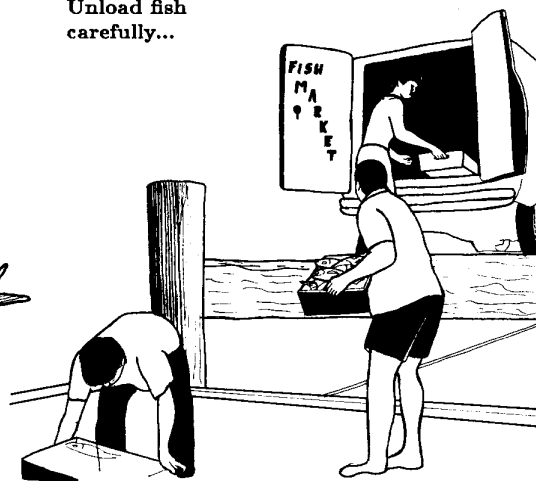

...dont throw them about

CHAPTER 8: AFTER FISHING

SECTION D: KEEPING RECORDS

By keeping records of his fishing and business activities, a commercial or semi-commercial fisherman will be aware of his own performance, and can continue to try to improve on it. At the end of each trip, it is useful to write down in a notebook the following details.

RECORD-KEEPING

Keeping proper records helps you run your boat efficiently



ENGINE HOURS

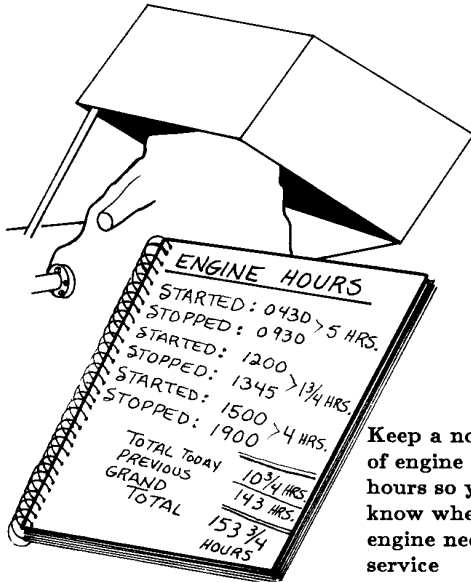

Keep a note of engine hours so you know when your engine needs service

Engine hours

An estimate of the number of hours the engine has been run should be made. This enables the fisherman to know when he should carry out basic maintenance procedures, such as oil changes, in accordance with the manufacturer's recommended procedures. Doing this will avoid dangerous and costly breakdowns and engine down-time.

Fuel consumption

By recording how much fuel was used on each trip, and knowing the number of hours the engine has run, the fisherman can calculate the average fuel consumption per engine running hour. This allows proper estimation of fuel consumption for long trips. It also allows him to keep a check on whether his boat is continuing to perform efficiently. If fuel consumption per engine hour starts to rise over a period of several trips, it could be an indication of engine malfunction. Alternatively, the boat may be getting badly fouled by growth on the hull, or may have suffered damage to the propeller.

FUEL CONSUMPTION

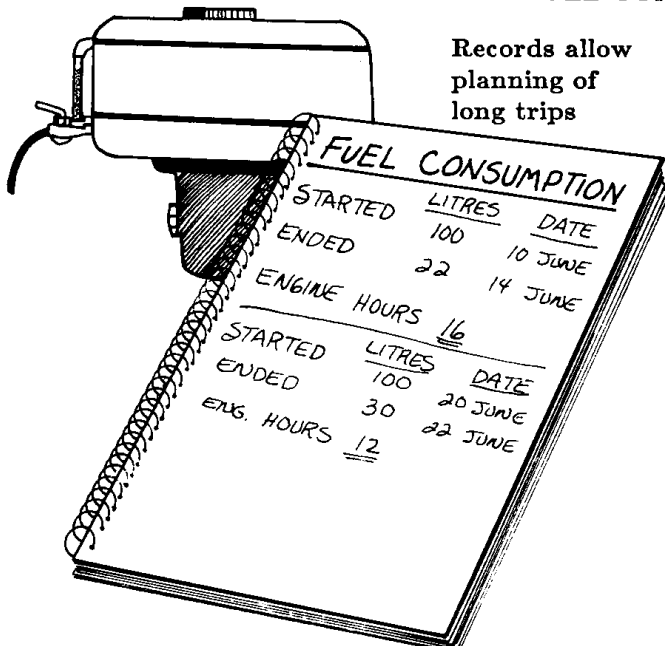

Records allow planning of long trips

High fuel consumption may mean engine problems

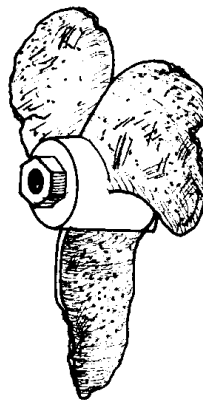

...or a damaged prop

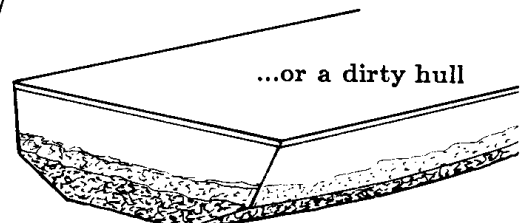

...or a dirty hull

Catch

By recording the approximate weight of the fish caught and the area where it was taken, the fisherman can build up a valuable log of his successes and failures over a period of years. This can be a useful reference for the future, reminding the fisherman of where his best catches came from during a given season, or the best time of day, tide or moon to fish in a particular area.

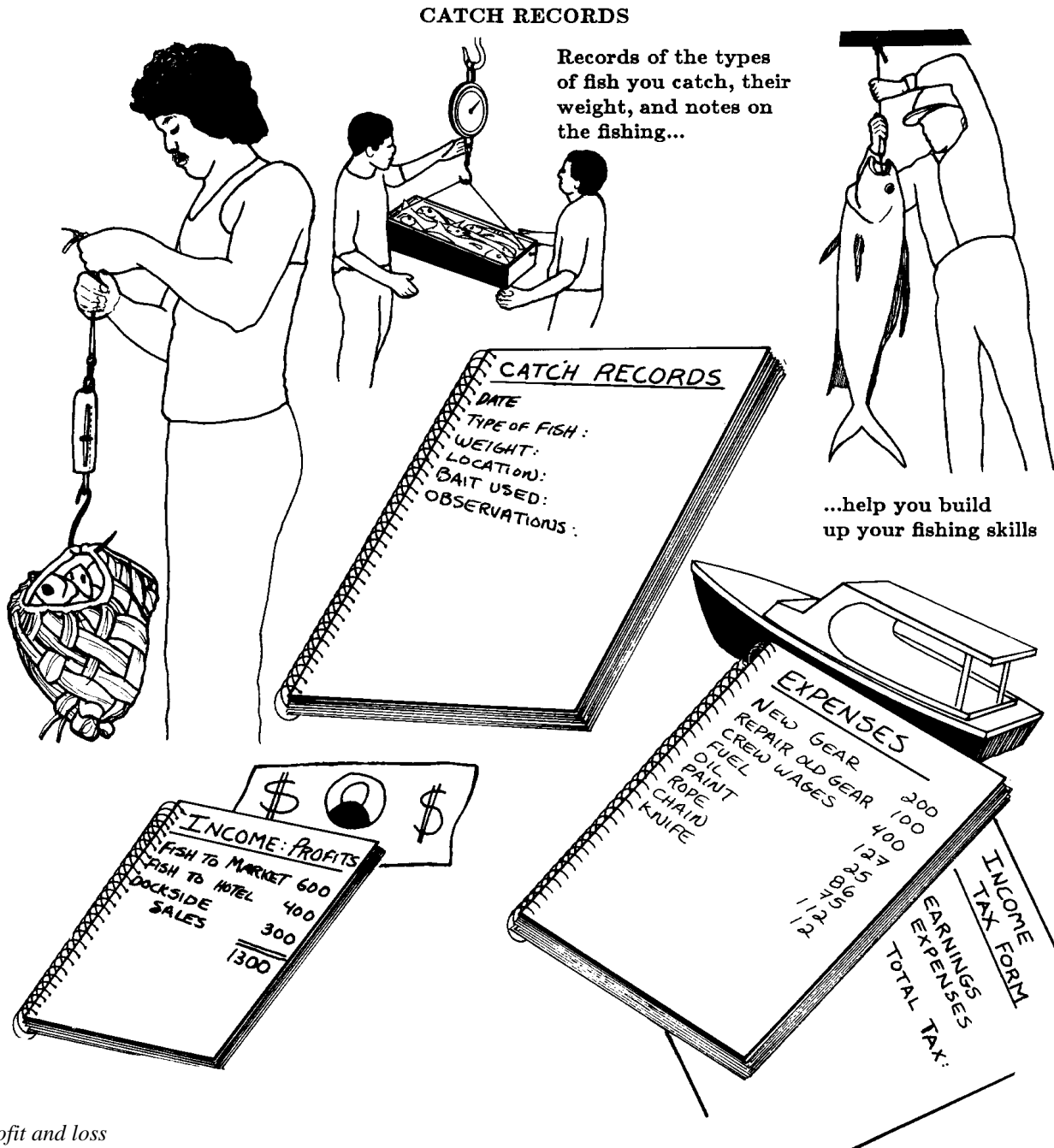

Profit and loss

When fishing on a commercial or semi-commercial basis, the fisherman should keep a running record of the money he spends on his fishing. This should include the cost of fuel, bait, crew wages, ice, rations, vessel and engine maintenance and repairs, gear, bank loan and interest repayments, etc. By balancing this against the income he receives for the sale of fish, and from any other activities (occasional charters, transport jobs, etc.), the fisherman can see the true profitability of his business, and areas where he could economise on costs.

Keeping receipts for all your expenses is essential if you want to claim against them when paying income tax.

CHAPTER 9

TROUBLE AT SEA

A. INJURIES- *Avoid accidents -First-aid kit -Minor cuts and burns- Getting a hook out of a hand
-Broken bones*

B. ACCIDENTS *-Coastal navigation -Lights -Man overboard -Fire*

C. BREAKDOWNS- *Engine maintenance -Tools and spare parts -Alternative propulsion
-Anchors and sea anchors*

D. SIGNALLING FOR ASSISTANCE *-Tell someone your plans -The 'SOS'signal -Arm signals
-The 'V' signal -Flares -Radio signals -Misuse of distress signals*

E. SURVIVAL AT SEA- *Supplies -Water collection -Shade -Warmth -Food -Avoiding accidents*

CHAPTER 9: TROUBLE AT SEA

SECTION A: INJURIES

Fishing boats are places where sharp and dangerous objects are being used to catch and subdue panicking and often powerful animals. Minor injuries such as cuts and bruises are almost a certainty, and there is great potential for more serious accidents. The sensible fisherman will take all reasonable precautions to reduce the chances of accidents to a minimum and be ready to cope with them when they do occur.

Alloid accidents

The boat's skipper should ensure that all his crew adopt safe working practices and avoid injury to themselves and other crewmen. In particular, gloves should always be worn to protect the hands from lines, hooks, fish spines and teeth, and knives. Fishing gear and knives should be stowed safely when not in use, where they will not slide about or be stepped on.

AVOID ACCIDENTS

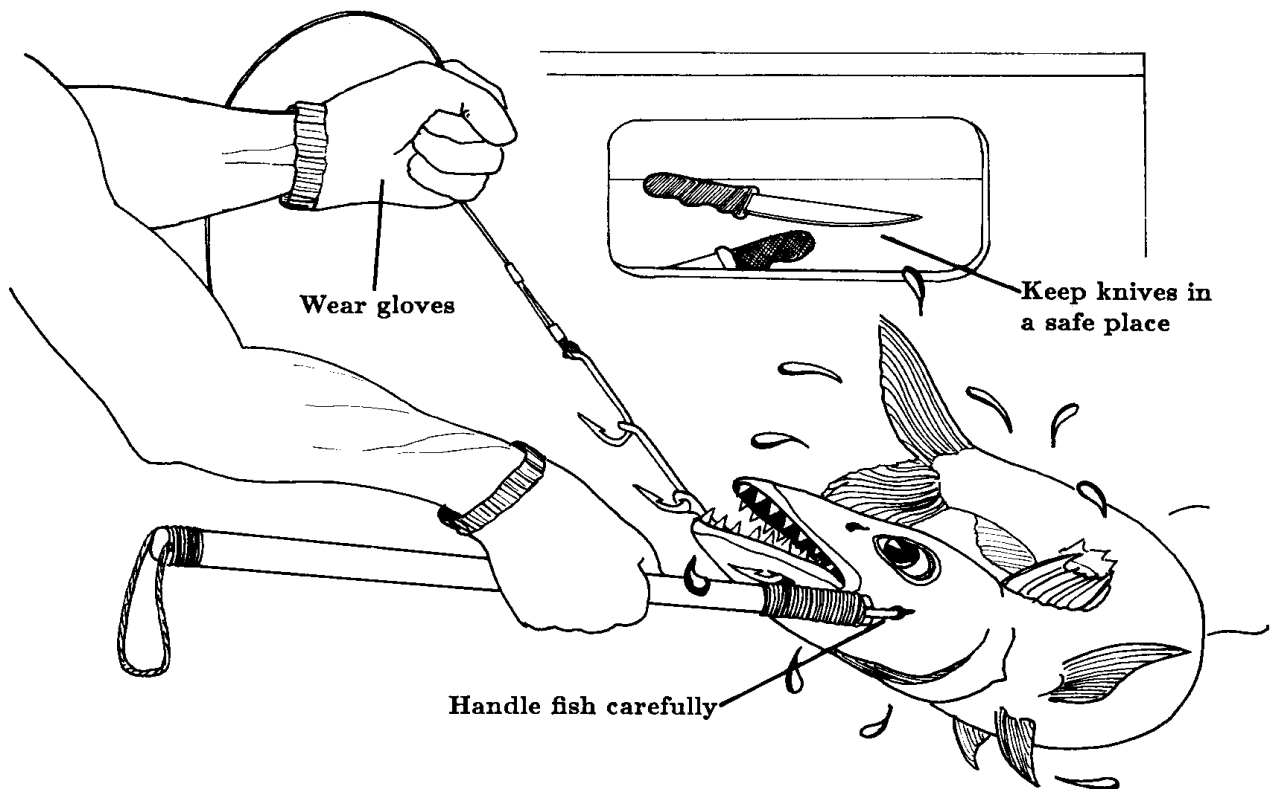

One of the most common causes of injury is from the handle of a spinning reel. Always use the braking system (Section 3N) and keep out of the way of the reel while a large fish is making its initial run.

First-aid kit

In many countries, the law requires boat owners to carry a basic first-aid-kit. Even where this is not mandatory, fishing boats should have some first-aid supplies on board. These should include panadol or panadol (for pain), bandaids, a couple of small bandages and some antiseptic liquid and ointment.

Every boat should have a first aid kit with ...

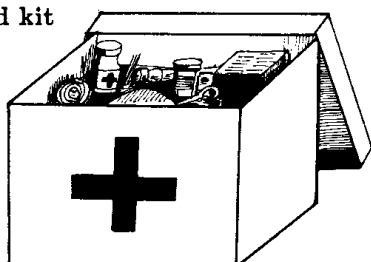

FIRST AID KIT

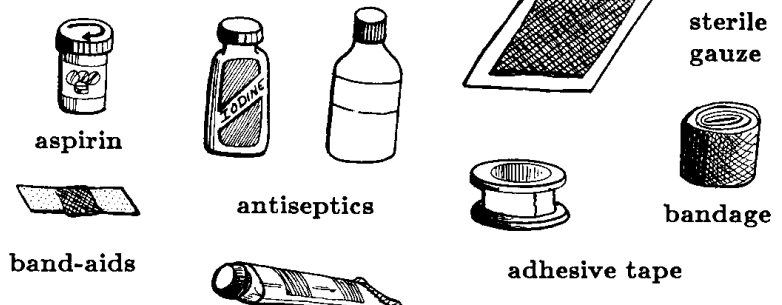

Minor cuts and burns

Fish slime is full of bacteria which can cause painful infections in even small knife cuts, hook scratches and line burns. These should always be washed in fresh water and then treated with antiseptic cream and covered using a band aid or small bandage. Gloves should always be worn to prevent any dressings on the hands being pulled off.

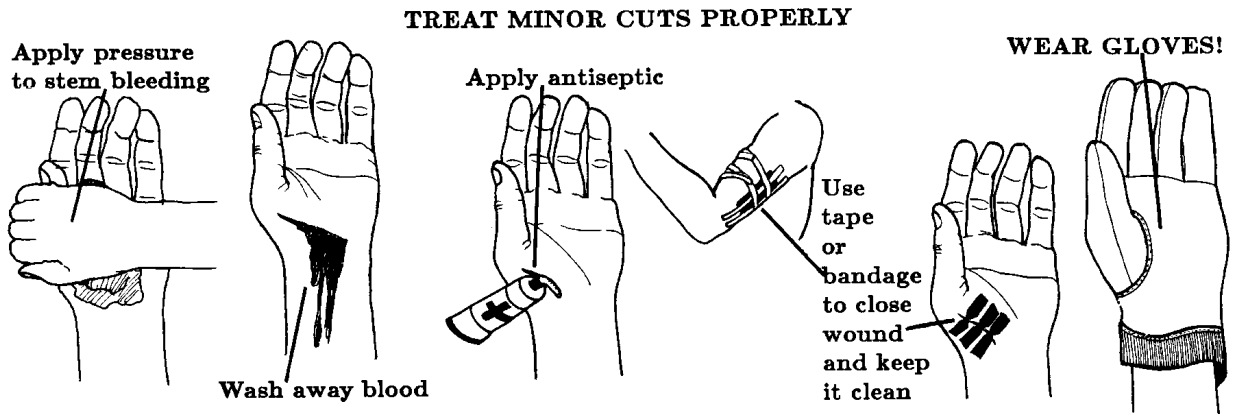

Getting a hook out of a hand

If a barbed hook gets impaled in a finger, or anywhere else, it is usually extremely painful to pull it back out again. A less painful way to get it out is to push the hook right through the flesh until the point and barb stick out clearly. Then, using pliers or wire cutters, snip either the eye or the barbed point off the hook. This will allow it to be pulled out more easily. If the hook is too thick to be easily cut, gently file down the barb, or squeeze it shut using pliers, so that it offers less resistance to being pulled back out.

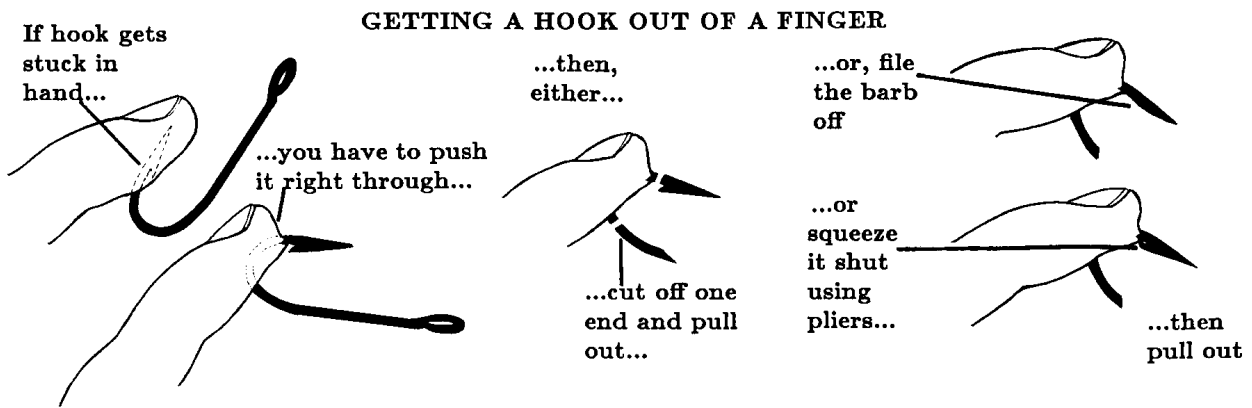

Broken bones

Again, this is a case where the best remedy is to get the injured person ashore as soon as possible. If the sea is rough and he is unable to lie in relative comfort, it may be necessary to try to relieve his pain by immobilising the broken bone. For a broken arm or leg, a splint made from a paddle or gaff handle should be tied along the broken limb, using cloth strips. This will keep the limb straight and prevent it from moving. For a broken collarbone, a cloth sling should be made to support the affected arm in a comfortable position across the chest.

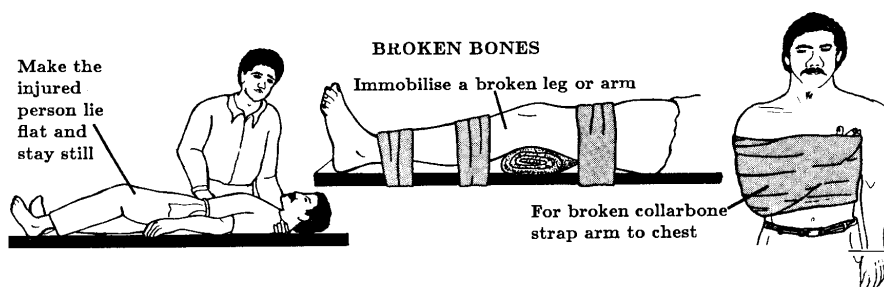

CHAPTER 9: TROUBLE AT SEA

SECTION B: ACCIDENTS

Most accidents at sea are caused by carelessness or lack of preparation. All boat owners have a responsibility to themselves and their crew to ensure that they have done their best to make sure that accidents will not happen, and to be in a position to cope with them if they do.

Coastal navigation

A basic knowledge of coastal navigation -the use of a compass and marine charts -is important to any fisherman travelling outside his own locality. As well as helping him locate good fishing grounds, the ability to navigate and read charts will assist him to avoid groundings, find shelter in rough weather, and locate places to put ashore in an emergency.

In areas where marine traffic is heavy, it is also important to know the rules of the road", that is, which boats have right of way in a given situation. This is especially so when trolling, when there is the risk of other boats running over the lines.

Lights

Most seagoing collisions occur at night, because people are not aware of the meaning of ships' lights and navigation markers. Learn the system of navigation beacons in your locality and the meaning of ships' running lights. A boats port (left) side should have a red light, its starboard side a green light, and its stern a white light. One or more white masthead lights may also be carried on larger boats. These lights allow you to work out the direction in which other boats are travelling, so you can avoid collisions. Know the meaning of the lights -and make sure you have lights yourself if you travel at night.

COASTAL NAVIGATION

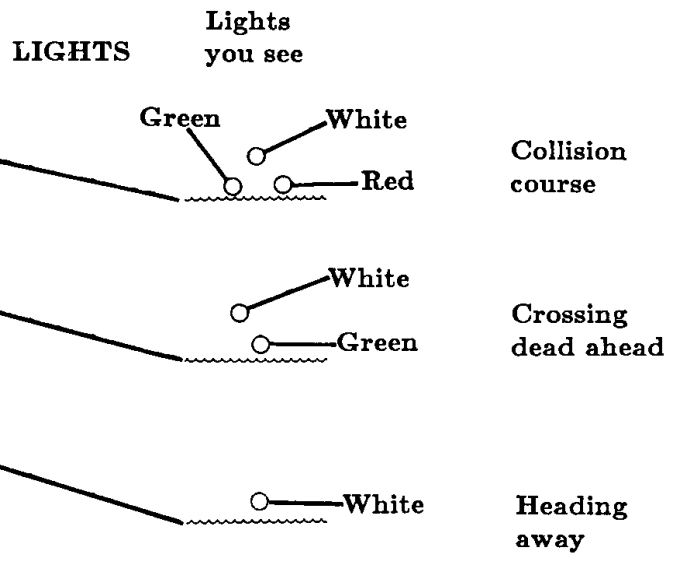
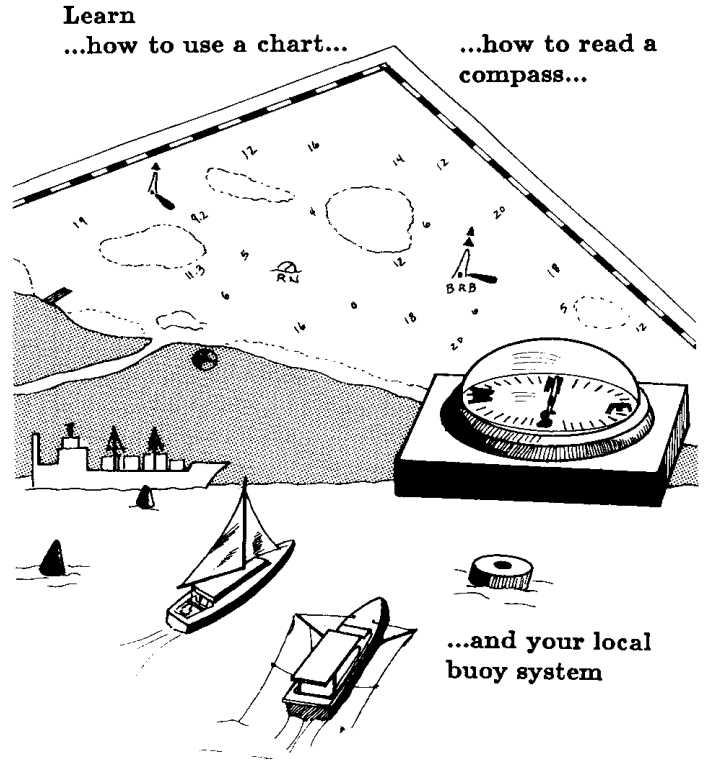

Man overboard

If one of the crew falls over the side, it is obviously necessary to go back and get him. Sometimes, it may not be possible to do this straight away -for example, if the vessel is under sail, or towing lines which could foul the propeller during a sharp turn. In such a case, the first priorities are to ensure that the man in the water does not drown, and to keep him in sight. This is best done by throwing overboard a large float for him to cling to, preferably something large and very visible, such as an orange float or life vest.

If there is no marker or float to hand, one of the crew should keep the man overboard in sight at all times, while the others ready the vessel (trim the sails, bring in the lines, etc.) prior to turning around to pick him up. If he becomes lost to view, it may be very difficult to spot him again from a distance, especially in rough weather.

MAN OVERBOARD

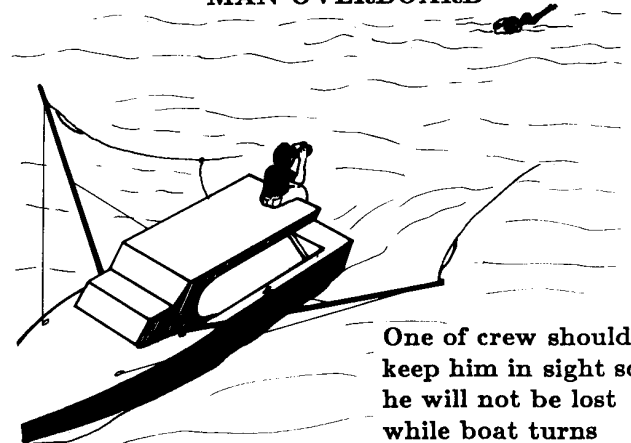

One of crew should keep him in sight so he will not be lost while boat turns around

FIRE EXTINGUISHER

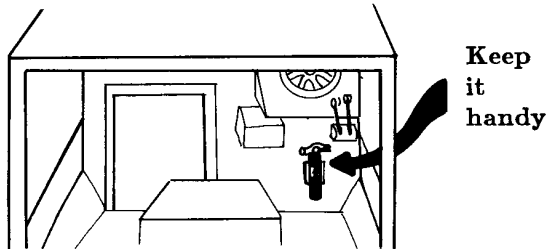

Suitable extinguishers

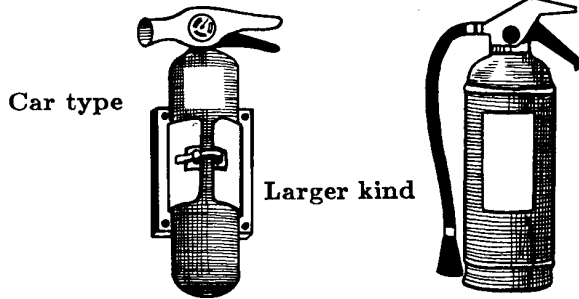

Fire

There is a fire risk on all small motorised fishing boats, due to the inflammable nature of engine fuels. It is always sensible (and in some countries mandatory) to carry a small fire extinguisher, which should be of the 'B' type, suitable for burning liquids as well as solids. These need not be expensive: small, cheap extinguishers sold for car, pleasure boat and camping use will usually be suitable.

Petrol is a much more flammable fuel than diesel (gasoil). WHEN PETROL IGNITES, YOU DO NOT GET A FIRE, YOU GET AN EXPLOSION OF WHICH THERE ARE NO WARNINGS AND OFTEN NO SURVIVORS. Petrol fumes present the greatest fire risk of all, so precautions should be taken to ensure that they do not build up. Petrol cans and tanks should be stowed in a ventilated part of the boat, and never in the cabin, where people may be smoking. Before starting inboard petrol engines, the box or cover should be removed for a few minutes to allow fumes to disperse. This will reduce the risk of an explosion caused by sparks from the starter motor's electrical system.

FUEL...

...is flammable and explosive. Take care

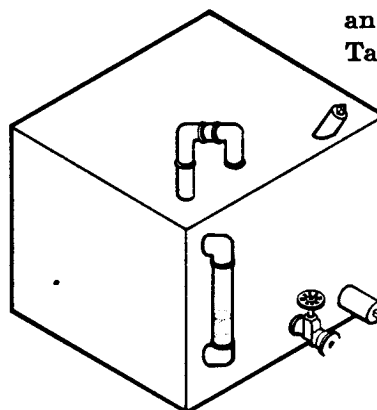
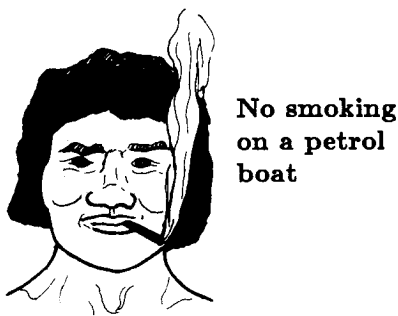

Careful with naked flames

No spare fuel in cabin

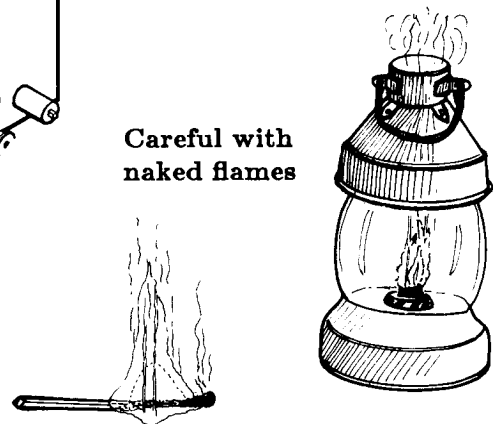
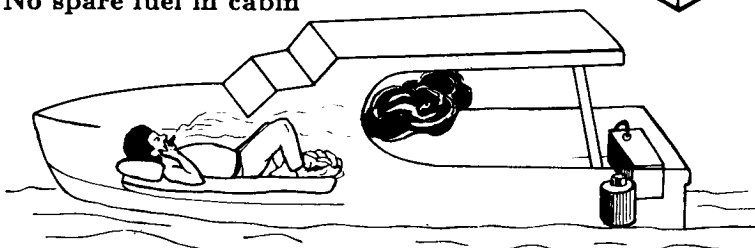

It is a sensible practice to ban smoking completely on board a petrol-driven boat. In any case, the lighting of cigarettes, Colman lamps, etc, should be done well away from fuel tanks and from the engine itself.

CHAPTER 9: TROUBLE AT SEA

SECTION C: BREAKDOWNS

Any commercial fisherman who puts out to sea regularly will experience engine breakdowns or other mechanical failures from time to time. Forethought and proper planning will usually stop these misfortunes becoming major disasters.

Engine maintenance

For an engine to keep on running smoothly and reliably, it needs regular maintenance. Read the manufacturers maintenance instructions and carry out the regular checks and tasks -changing the oil, cleaning plugs and points, replacing oil and fuel fillers, checking wear on seals and bearings, etc. Learn to carry out the maintenance routines yourself, if necessary under the guidance of an experienced mechanic when this is possible. In this way, you will become familiar with the engine and its individual quirks, and will slowly build up a collection of the tools you need to carry out routine repair jobs.

MAINTENANCE

**Know your engine
Learn how to do
routine service
and maintenance**

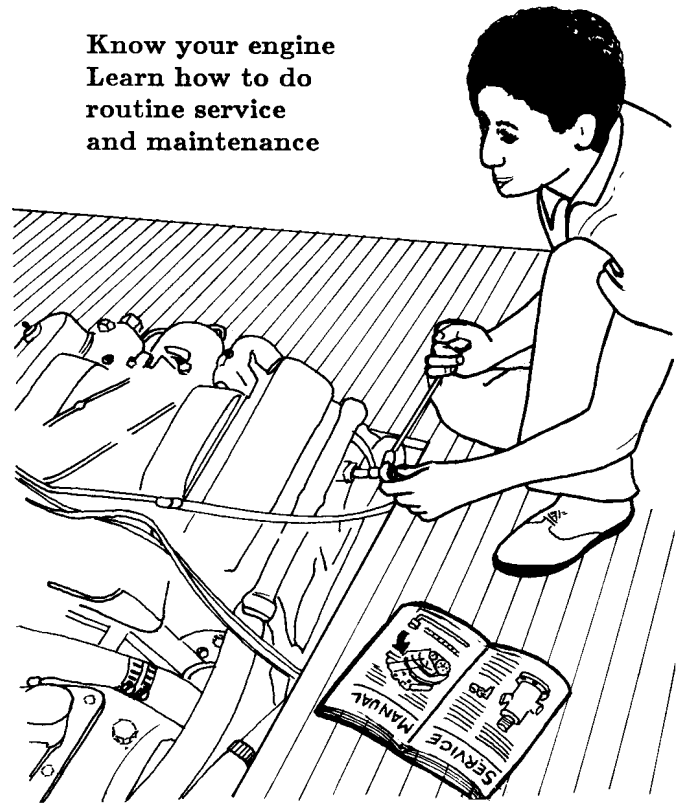

TOOLS AND SPARES

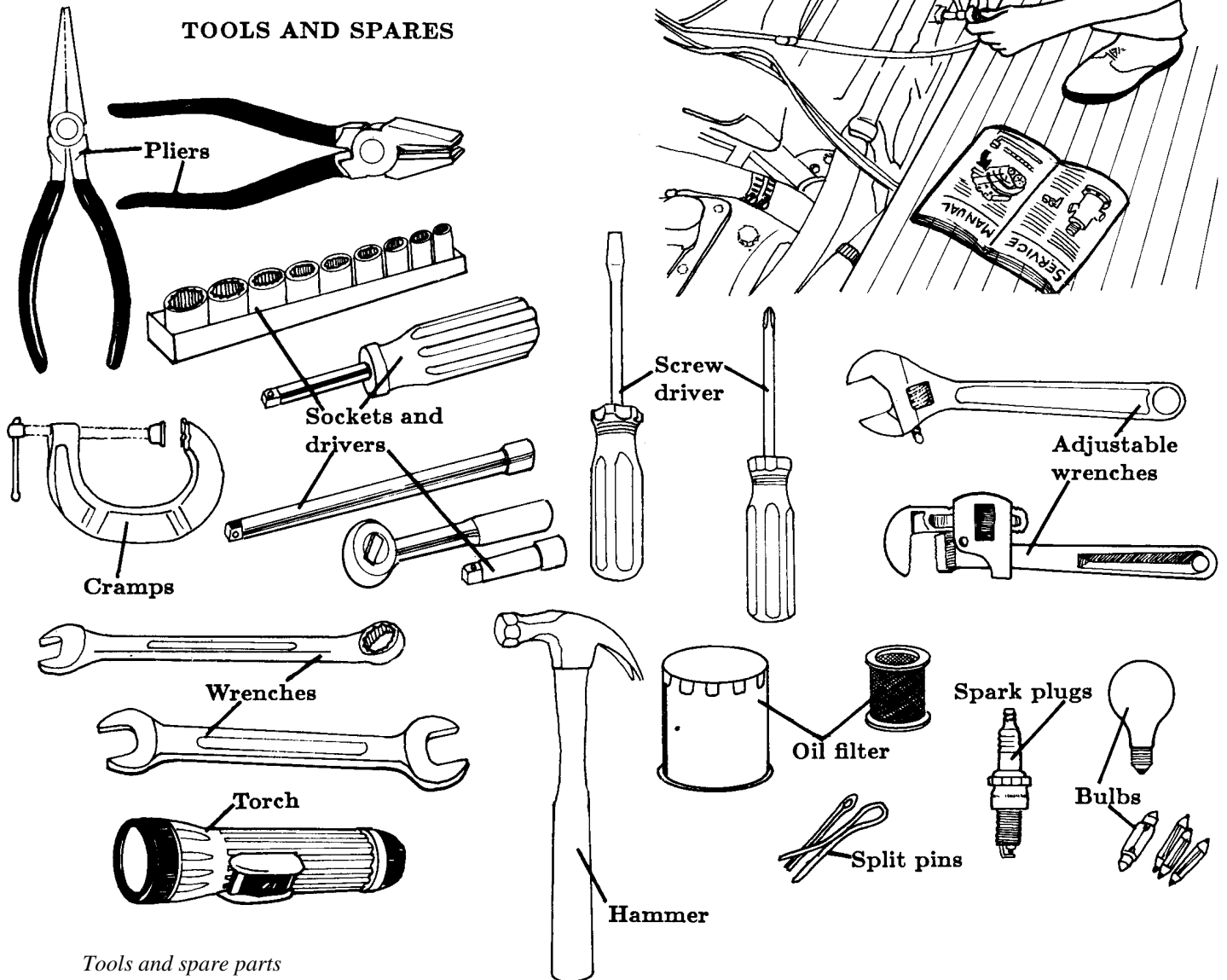

Tools and spare parts

Never leave shore without the tools and spare parts you will need to fix minor breakdowns. What you need depends on the engine you have but you should always be ready to cope with common problems such as blocked fuel lines, pumps and carburetors, dirty spark plugs, and dampness or salt water in the electrical system. Take an adequate range of spanners (wrenches), screwdrivers and an aerosol can of water-repellent oil (WD40, CRC or similar). Be ready for repeats of any problems you have had in the past.

Alternative propulsion

All motorised boats should have an alternative way of returning to shore or to safety if the main engine breaks down and cannot be repaired on the spot. For small boats, paddles may be adequate, while an emergency sail can be carried on a vessel equipped to use one. Most boat owners opt for a small auxiliary outboard motor. In this case, the spare motor should be used regularly, even if only for a 10-minute test run every week or two. If an auxiliary motor is allowed to lie idle for too long, there is a good chance that it will not start when needed.

ALTERNATIVE POWER

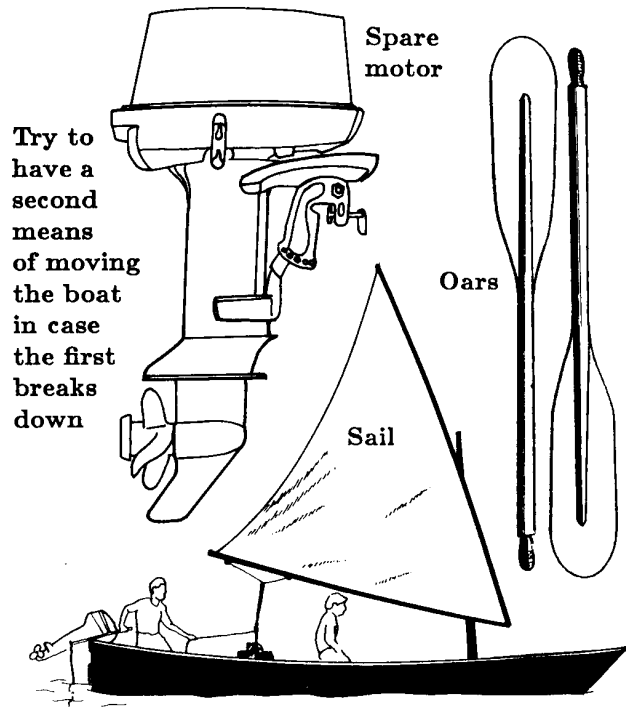

SEA ANCHORS

For deep water slow down drifting using buckets...

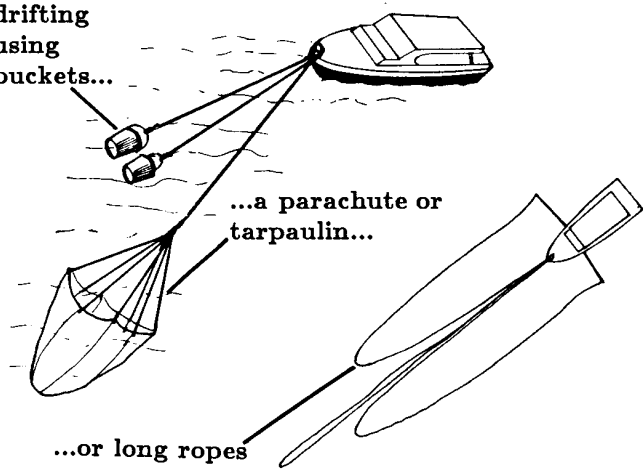

Anchors and sea anchors

In the event of a complete breakdown, it is important to check the direction in which the boat is drifting straight away. Current and tide will affect the direction of drift to some degree, but the most important factor for a small boat is the wind. Unless the boat is moving back to shore, it should be anchored to prevent it drifting out of sight of land and possible help. Being stationary also make it easier for searchers to locate the boat after flares or other signalling devices (see Section 9D) have been used.

The boat should therefore carry adequate anchor gear at all times. This should consist of a real anchor (not a rock or lump of coral), at least 5m of chain, and a sensible length of strong rope. The gear should be able to hold the boat in a strong blow.

If the breakdown happens in deep offshore waters, where the anchor will not reach the bottom, the drift can still be slowed down a lot by improvising sea anchors. This can be done by tying buckets onto the ends of ropes, or making an underwater 'parachute' from a tarpaulin or canvas, and trailing them in the water. If buckets or tarpaulins are not available, a surprising amount of resistance against wind drift can still be created simply by trailing as much rope in the water as possible.

SAFETY ANCHORS

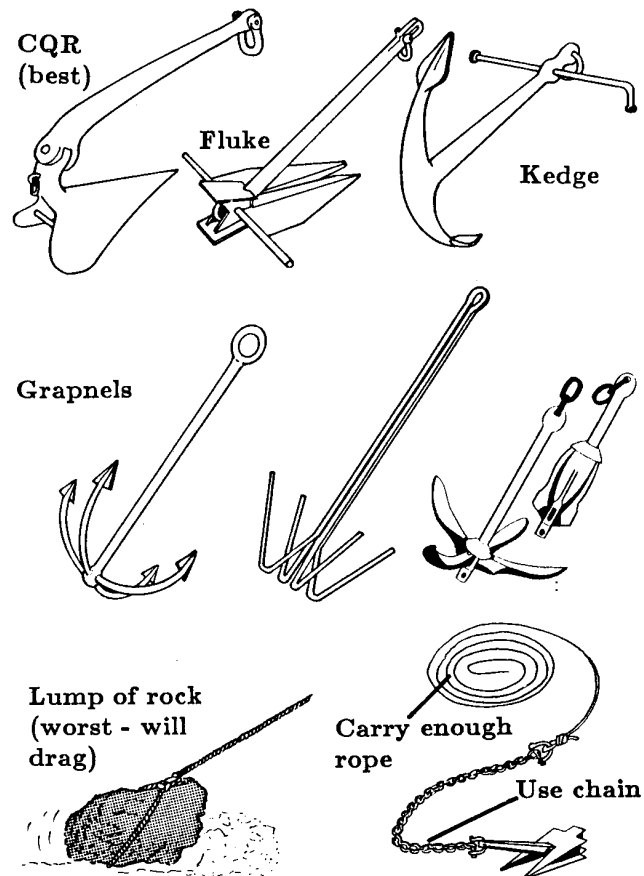

CHAPTER 9: TROUBLE AT SEA

SECTION D: SIGNALLING FOR ASSISTANCE

The crew of a small vessel in distress usually need to obtain assistance as quickly as possible. Knowing certain distress signals, and being able to make them, may attract attention to the fact that the boat is in trouble, or help searchers locate it more easily.

Tell someone your plans

Before setting off, tell a member of your family or someone close to you roughly where you are going and how long you expect to be away. If you are very late in returning, that person can raise the alarm and direct a search party to the right area.

TELL SOMEONE YOUR PLANS...

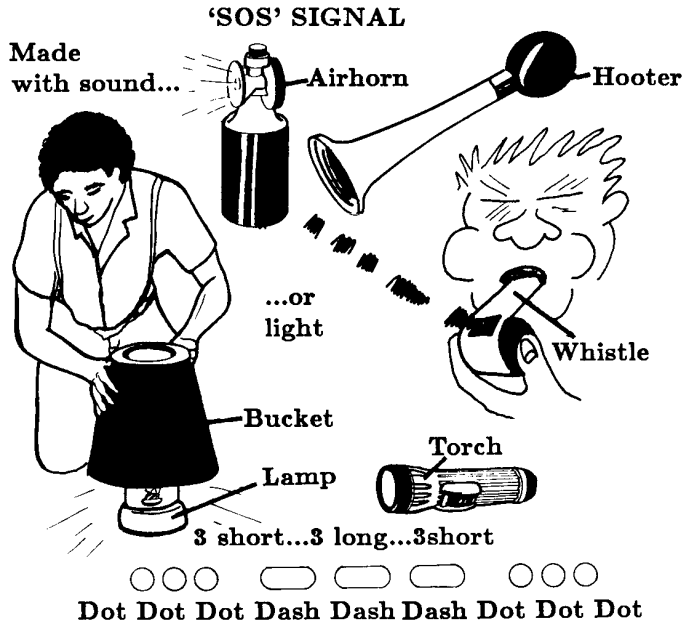
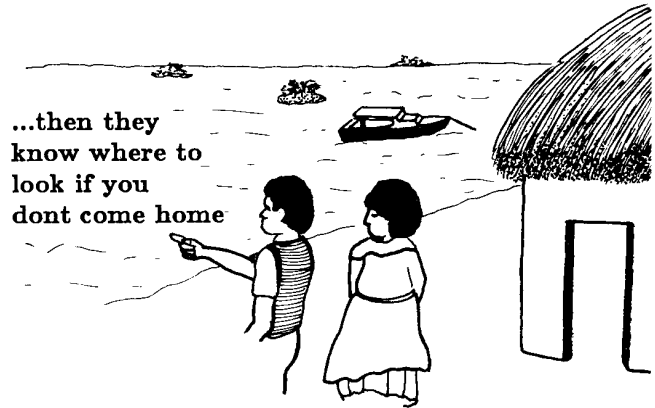

The 'SOS' signal

This is the best known of all international distress signals, and consists of three short pulses, followed by three long ones, then three short ones again, the whole group being repeated regularly. The 'SOS' signal can be made using lights -for example, switching a torch (flashlight) or masthead light on and off, using a bucket to cover and uncover a Colman lantern, or in the daytime, using a mirror or other flat, shiny object to flash sunlight towards an observer. The signal can also be made using sound if a whistle, hooter or other sounding device is to hand.

Arm signals

The international arm signal for distress is to hold the arms out horizontally from the sides and lower and raise them repeatedly. However, this signal is not very well known and in the Pacific Island region, it is probably more effective to wave the arms about frantically using a coloured cloth or a shirt as a flag.

ARM SIGNALS

The correct arm signal for distress...

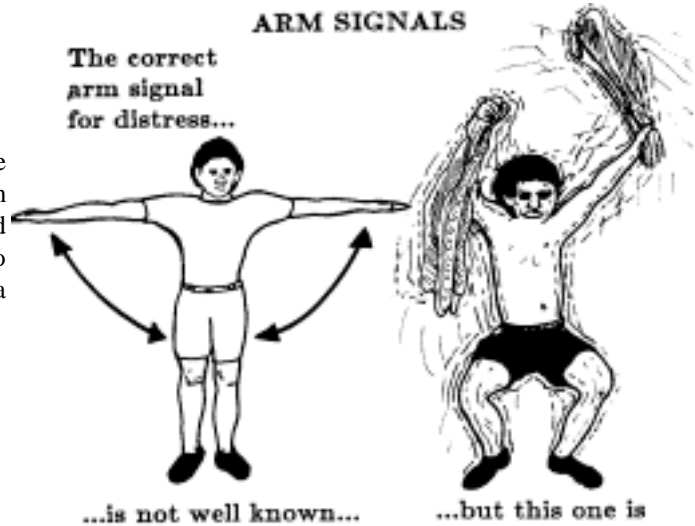

The 'V'signal

'V' SIGNAL

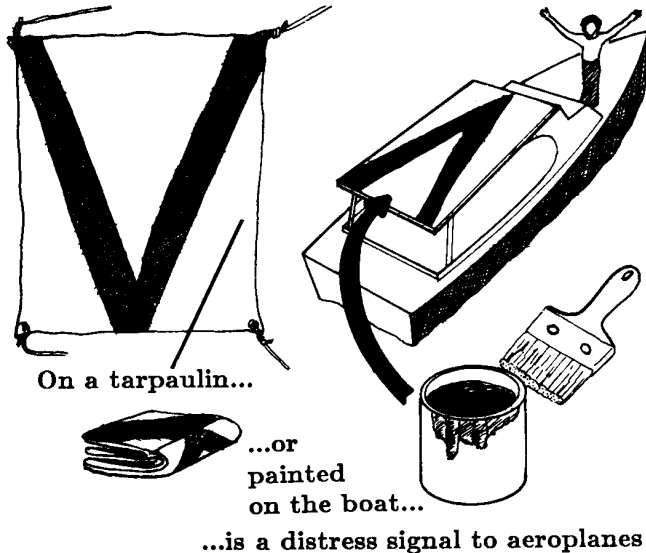

The letter 'V' painted on a boat deck is another international distress signal, particularly useful if you are trying to attract the attention of aeroplanes. The 'V' can be painted on the back of a tarpaulin ready for emergency use. (Make sure that the 'V' is never displayed during normal use). Alternatively, if there is a pot of paint on board, it can be painted directly onto the deck or cabin top.

Flares

One of the best ways to attract attention and to signal distress is to use flares, of which there are two main types. Smoke flares are for daytime use only and are practically invisible at night. 'Starburst' or 'parachute' flares which shoot a burning red or white firework into the air, are clearly visible in daylight but are even more noticeable at night. For practical purposes, starburst flares are much more useful for alerting distant observers that a boat is in trouble. Smoke flares are only good in daylight, and then only if the observers are relatively close by or at high altitude. However, smoke flares are very valuable for assisting actively searching planes and boats to locate the vessel in distress.

ALL small fishing boats should carry a minimum of three starburst flares at all times. They can usually be bought quite cheaply, and could well save lives -perhaps yours. If you do have to use flares, try to do so when there are most likely to be people awake and outside to see them. Fire the flares straight up for maximum visibility. Spread them out allowing a reasonable time (2-3 hours) between flares, rather than firing them all off at once. Don't waste your flares unless you think there is likely to be someone around to see them.

FLARES

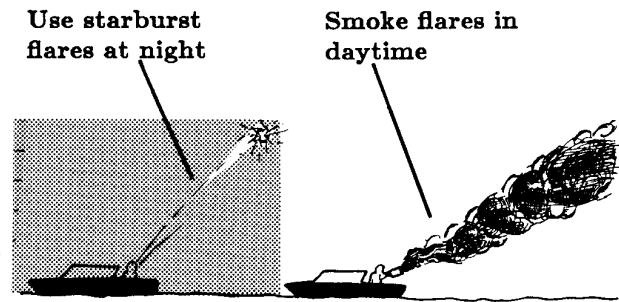

Fire flares off when you are sure someone will see them



RADIO SIGNALS

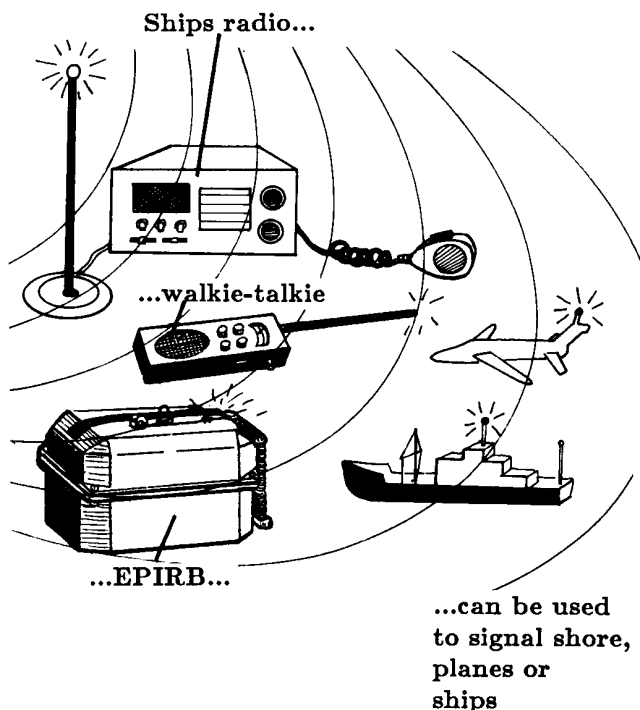

Radio signals

The most effective way to attract attention in areas close to urban centres is to carry a single-side band or VHF 2-way radio. Although expensive, this is the best way to call for help, provided that you know the frequencies to use to contact the local marine radio station, coastguard, or other vessels. Unfortunately, radio facilities are not very useful in most rural or outer-island areas in Pacific island countries.

Another radio device is the EPIRB (Emergency Position Indicating Radio Beacon). These units are now commonly available and when activated emit signals on international distress frequencies which can be picked up by passing planes or boats, or nearby shore stations. EPIRB signals can be detected by radio receivers hundreds of miles away.

Misuse of distress signals

Distress signals should never be made except in cases of real emergency. As well as being foolish and dangerous, deliberately making false distress signals is punishable by law in most countries. The penalties are usually severe, and may include the guilty party having to pay the entire cost of any search and rescue operations mounted on his behalf.

CHAPTER 9: TROUBLE AT SEA

SECTION E: SURVIVAL AT SEA

If misfortune befalls a fisherman and he finds himself drifting lost at sea, there are a few important tips he should know to increase his chances of survival until help arrives.

Supplies

Never set off without adequate food and water for the fishing trip, and **ALWAYS CARRY PLENTY OF SURPLUS WATER**. Thirst is a much greater threat than hunger. If he has to, a man can survive for several weeks without food, but only for a few days without water. Keep a few gallons of emergency water rations on board your boat at all times.

WATER COLLECTION

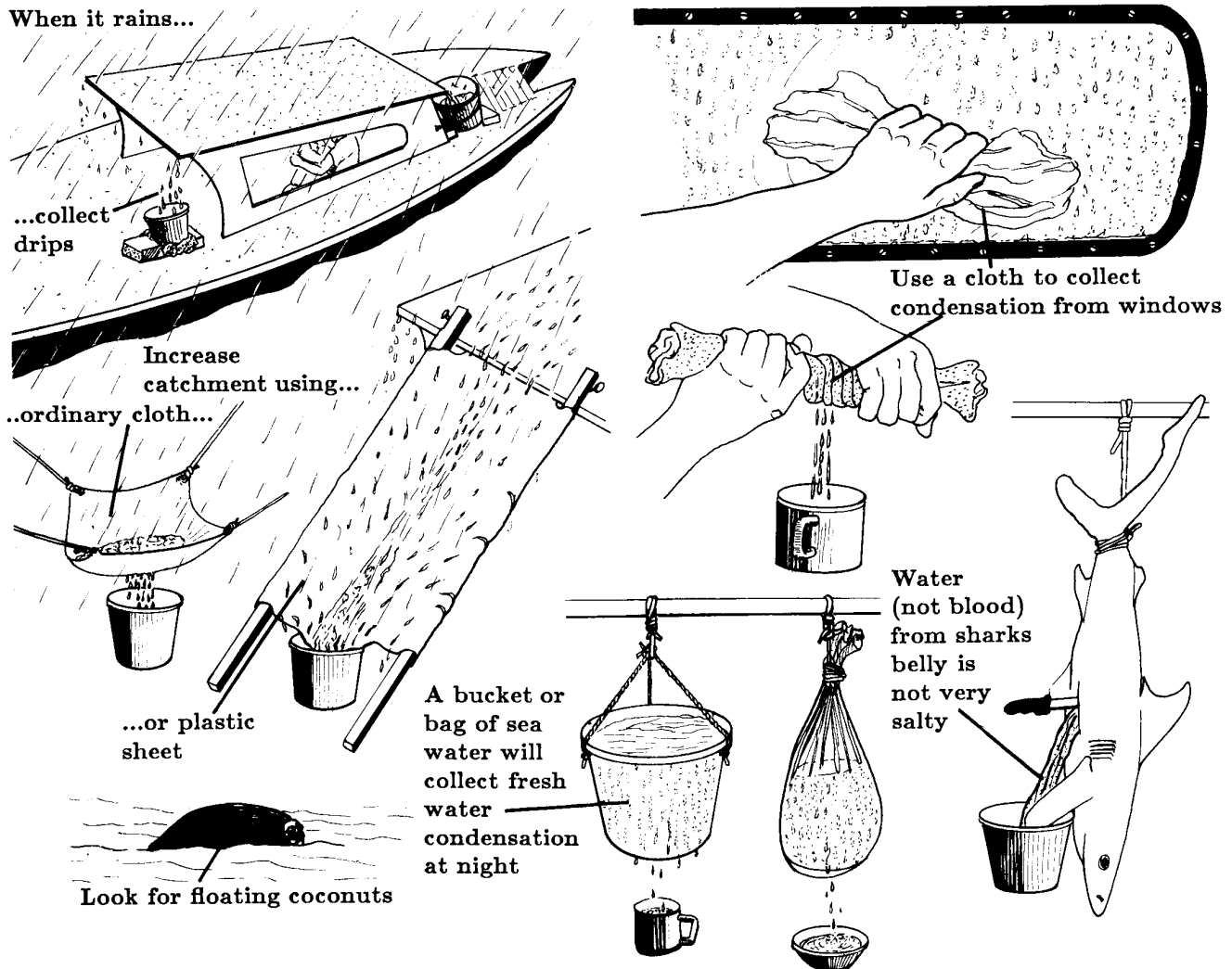

Water collection

Even before your water supplies start to run low, make every effort to use as little as you can, and to collect extra water at every opportunity.

When it rains, use buckets to collect drips or run-off from the deck or cabin top, or arrange a tarpaulin, cloth or canvas as a collector.

During the night, fresh water will condense on cold objects, such as glass windows, metal items, the deck and the inside of that part of the hull which lies below the waterline. Try to collect it, and to improvise additional condensation collectors, such as plastic bags or buckets filled with seawater. These will cool down during the night, so that condensation forms on the outside and this can be shaken or scraped off into a cup or bowl.

Other sources of water include the juice of drifting coconuts, and the fluid from the belly cavity of sharks. This fluid is foul-tasting, but has a low salt content and can be tolerated by the human body if things are really desperate. A number of drifting micronesians are known to have survived by drinking shark "belly-water" (not blood).

Shade

As far as possible, stay out of the sun during the daytime. If you have no shelter on your boat, try to rig up some sort of shade from clothing, a tarpaulin, or deck boards. This will reduce the risk of sunstroke or severe sunburn, and cut down on water loss from the body. The result is that less drinking water will be used, and water supplies will last longer.

WARMTH

Shelter from wind and rain



If no shelter, it may be warmer to hang in the sea for short periods during squalls

Food

Try to catch fish or seabirds to eat rather than consuming any preserved or canned food you have on board -save this for as long as possible. Improvise harpoons to catch basking fish, sharks or turtles which may approach the boat. If you have lamps, use them at night to attract fish close to the boat where they can be speared, hooked or netted.

Avoiding accidents

Breakdowns at sea, small boats going missing and fishermen drifting ashore in other countries after spending days or weeks at sea, are all-too common events in the Pacific islands region. Sometimes the boat crew survive, but in many instances, there is considerable unnecessary suffering and loss of life. A large proportion of such mishaps are caused by carelessness or inadequate preparation by fishermen before fishing trips.

In this book, we have tried to emphasise the importance of thoughtful planning before heading out to sea. Make sure that you are one of those who avoids accidents by adopting safe fishing practices and preparing carefully for each fishing trip.

SHADE

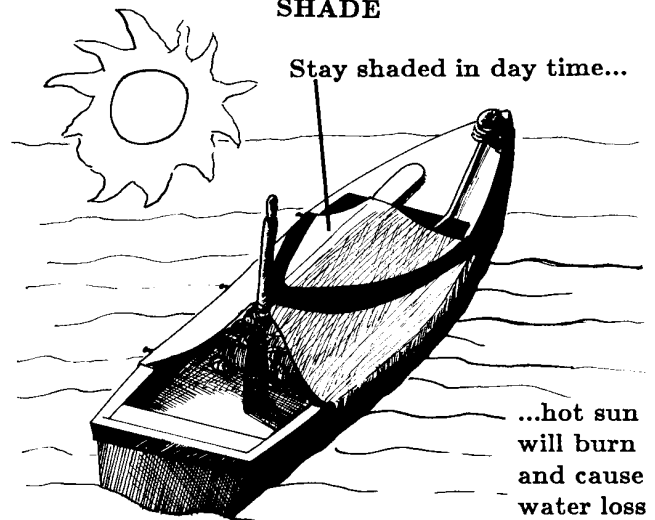

Warmth

Hypothermia (excessive body heat loss) can lead to death, and is a threat, even in the tropics. This is particularly true in small open boats, where there is no shelter from the elements. A long period of exposure to wind and rain can cause rapid chilling. If no protective clothing or shelter is available, it may be warmer to hang over the side of the boat in the water for short periods of time.

FOOD

Make a spear or harpoon to catch fish, turtles and birds

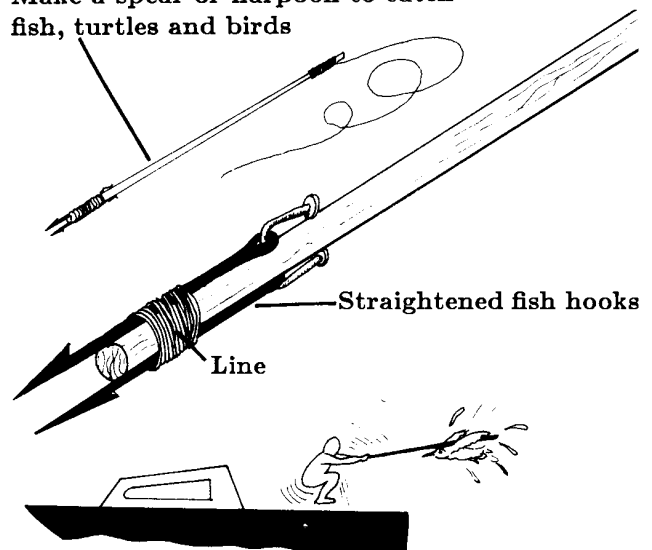



Location: Tarawa,

Photo: B.R. Smith

Small-scale pole-and-line fishing from modern plywood canoes

APPENDICES

APPENDIX 1: POLE-TROLLING IN THE PACIFIC TRADITION -*Fishing gear -Fishing techniques*

APPENDIX 2: FURTHER READING

APPENDICES

APPENDIX 1: POLE-TROLLING IN THE PACIFIC TRADITION

Pole-trolling (also called pole-and-line fishing and pearl-lure fishing) is a fishing method which evolved in the islands and atolls of Oceania and which dates back thousands of years. Originally practised from traditional paddling or sailing canoes (and still done this way in a few places), the technique has been modified in other locations to take advantage of modern fishing gear and motorised vessels. Nonetheless the essential skills involved remain largely the same.

Fishing gear

The gear for this type of fishing consists of a long pole, about 7m (20 feet) in length, to the tip of which a line about the same length as the pole is attached. A lure is tied to the other end of the line.

Traditionally poles were made of bamboo or strong, light wood. For the most part, fishermen relied on finding these materials drifting at sea, since they do not usually grow on small islands and atolls. In more modern times, bamboo is easier to obtain. In more urbanised areas, fibre glass poles are sometimes used.

The lines were originally hand-made from braided hibiscus or sennit fibres, but have now been largely replaced by modern synthetic fishing lines, which are stronger and may be easier to obtain.

One traditional element which still remains, however, is a universal preference among fishermen for lures made from the shells of mother-of-pearl oysters. Similar lures made of iridescent plastic are commercially available, but although these are cheaper and do not require hours of patient construction and polishing, they have rarely succeeded in overcoming the preference for the traditional version. Modern lures are much the same as those of many generations ago, except that metal is now usually used for the hook section, rather than the more traditional materials of turtle shell, bone or coconut shell.

The lures themselves consist of a curved strip cut from a mother-of-pearl shell, fitted with a barbless hook and a tassel of feathers or fibres. Very subtle variations in the colour, shape and size of a lure are considered of vital importance to fishing success, and this is one of the reasons why natural materials are still preferred to synthetic ones. A fisherman may have several poles, each with several lures attached but tied back, plus a large collection of spare ones ready to hand. Only one lure is in use at anyone time, the fisherman switching among lures of varying appearance until he selects one which produces the desired results.

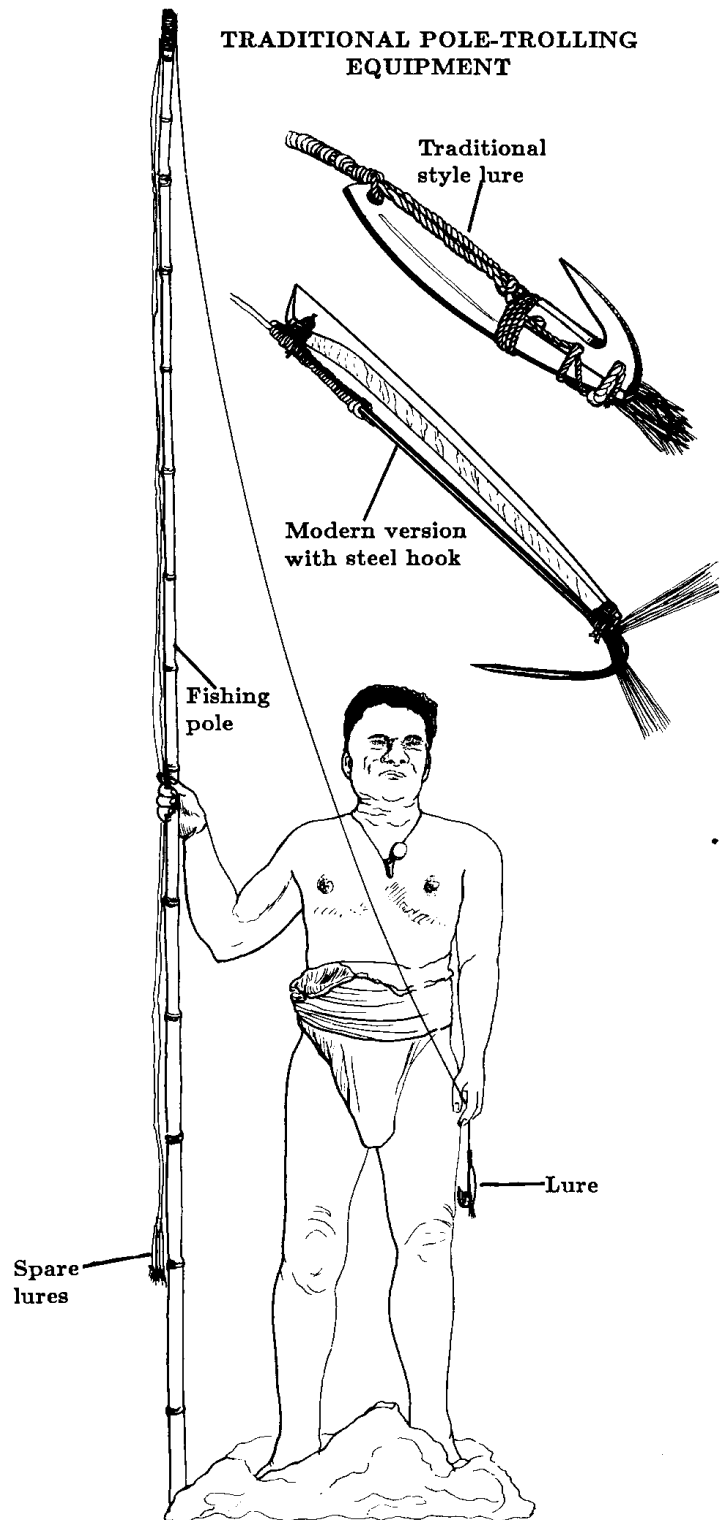

Fishing techniques

The technique is to locate schools of actively feeding tuna, and to slowly troll the lure among them. The lure is extended out behind the boat using the combined length of the pole and the line to distance it as far as possible. When a fish strikes, the pole is used to heave it into the boat, where it usually hits the lap of the fisherman and falls to the bilge or deck. A lot of skill is required in ensuring that constant tension is kept on the line, so that the fish does not come off the barbless hook before being boated, and in manipulating the fish into precisely the right spot in the boat. A skilful fisherman can have his lure back in the water almost before the fish he has just caught hits the deck.

FISHING TECHNIQUE

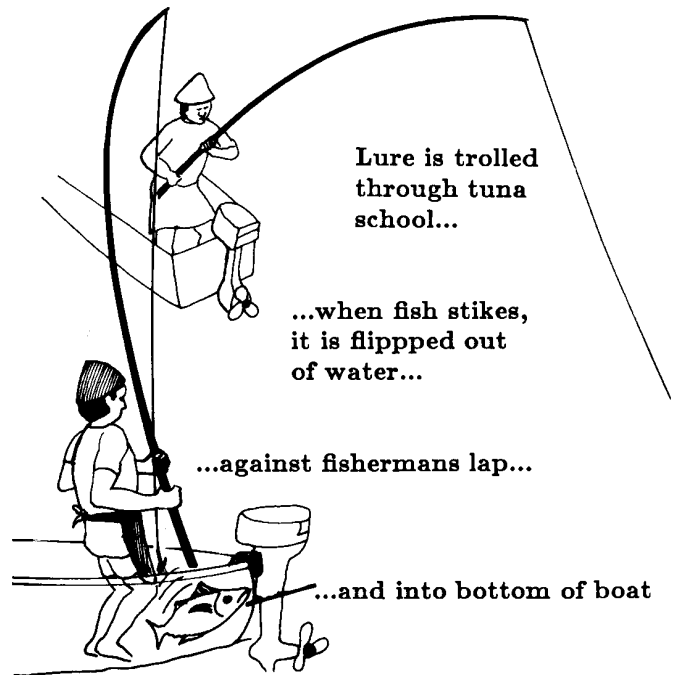

Traditionally, this type of fishing was – and in some places still is – carried out according to very rigid social or cultural rules. Working in the confines of a narrow canoe, each member of the fishing team had a precise job to do, whether this be paddling, steering or killing the fish just boated. Only one man was allowed to carry out the actual fishing, and years of experience in all manner of seagoing and resource-harvesting skills were required to qualify him for the job. He was the vessels skipper, and used his experience and skill to direct the other members of the crew, control the fishing operation and, ultimately, maximise the catch.

TRADITIONAL STYLE

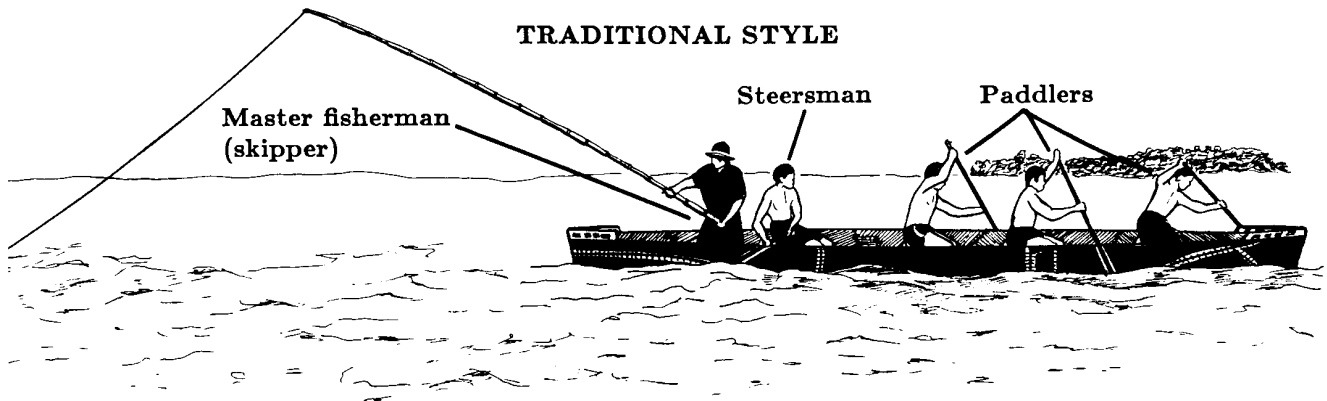

MODERN STYLE

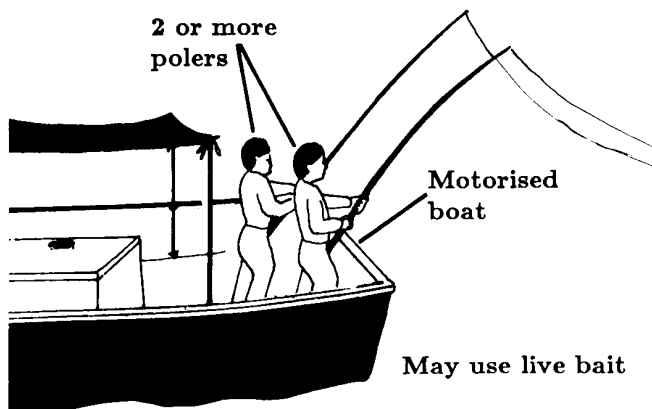

More modern versions of the technique use motorised vessels, and usually involve two or more fishermen poling simultaneously. Although the rich cultural background to the technique may be diminishing in its importance, the skills of locating the fish, and selecting precisely the right lure to obtain a maximum biting response from them remain as crucial as ever.

APPENDICES

APPENDIX 2: FURTHER READING A2: Further Reading

The following books all contain useful information and ideas for people interested in knowing more about some of the subjects covered in this book.



FISHING HAWAII STYLE (Volume 1) by Jim Rizutto.
Published 1983 by Hawaii Fishing News Ltd., Honolulu, Hawaii, U.S.A. 146 pages.
Contains many useful trolling tips, especially about big game fishing, from Hawaii's sport fishermen. Very well illustrated.



MODERN HAWAIIAN GAME FISHING by Jim Rizutto.
Published 1977 by the University Press of Hawaii, Honolulu, U.S.A. ISBN 0-8248-0481-30. 254 pages.
Even more detailed information on sport and big game trolling, based on discussions with Hawaii's most successful sport fishermen and charter boat skippers.

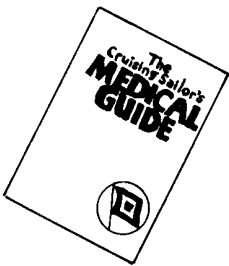

THE CRUISING SAILORS MEDICAL GUIDE by Nicholas C. Leone, M.D., and Elizabeth C. Phillips, R.N.
Published 1979 by David McKay Company, Inc., New York. ISBN 0-679-50954-2. 207 pages.
As easy-to-follow guide showing first-aid treatment for almost all the minor illnesses and accidents imaginable on board a small boat.

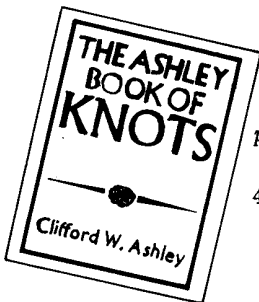

THE ASHLEY BOOK OF KNOTS by Clifford W. Ashley
Published 1975 by Faber and Faber Ltd., London, England. ISBN 0-571-09659-X. 629 pages.
Possibly the most comprehensive knot book available. 7000 drawings illustrate nearly 4000 knots, splices, and related pieces of ropework and seamanship.



FAO SPECIES CATALOGUE, VOLUME 2: SCOMBRIDS OF THE WORLD by Bruce B. Collette and Cornelia E. Nauen.
Published 1983 by the Food and Agriculture Organisation of the United Nations, Rome, Italy. ISBN 92-5-101381-0. 137 pages.
Provides wide-ranging information on the habitat, biology and fisheries of the 49 known species of tunas, mackerels and bonitos.



BIG FISH AND BLUE WATER by Peter Goadby.

Published 1970 by Angus and Robertson Publishers Ltd., Sydney, Australia. ISBN 0-207-14192-0. 334 pages.

Another book mainly for game fisherman, but with many tips from areas within the Pacific Islands region, as well as Australia and New Zealand. Illustrated with superb game fishing photographs.

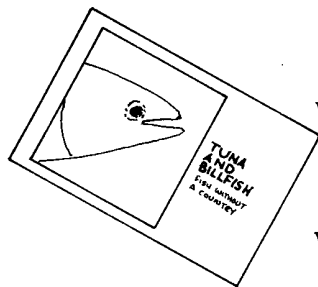

TUNA AND BILLFISH: FISH WITHOUT A COUNTRY by James Joseph, Witold Klawe and Pat Murphy.

Published 1979 by the Inter-American Tropical Tuna Commission, La Jolla, California, USA. ISBN 0-9603078-0-X. 46 pages.

Describes the life cycles of tunas and billfish in a non-technical style. Nicely illustrated with paintings by artist George Mattson.

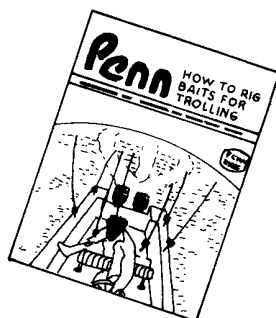

HOW TO RIG BAITS FOR TROLLING: PROFESSIONAL GUIDE FOR RIGGING BAITS FOR SALT WATER FISHING.

Published in 1985 by Penn Fishing Tackle Manufacturing Co, Philadelphia, Pennsylvania, USA. 63 pages.

Although written for game fishermen, this is an excellent guide which shows several bait rigging methods that will be useful to all troll fishermen. Each method is illustrated with photographs, and contains many handy tips.

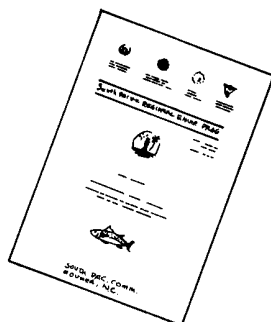

TRADITIONAL TUNA FISHING IN TOKELAU. SPREP Topic Review No. 27 by Robert Gillett.

Published in 1985 by the South Pacific Regional Environment Programme, South Pacific Commission, Noumea, New Caledonia. 51 pages

Presents a great deal of biological and technical information on the traditional Tokelauan style of pole-and-line fishing for tuna.